

STEREO CASSETTE DECK WITH DOLBY-NR SYSTEM

MODEL AD-6800H,EE,UK

AIWA SALES & SERVICE LTD

01 993 1672

AIWA®

[SERVICE MANUAL]

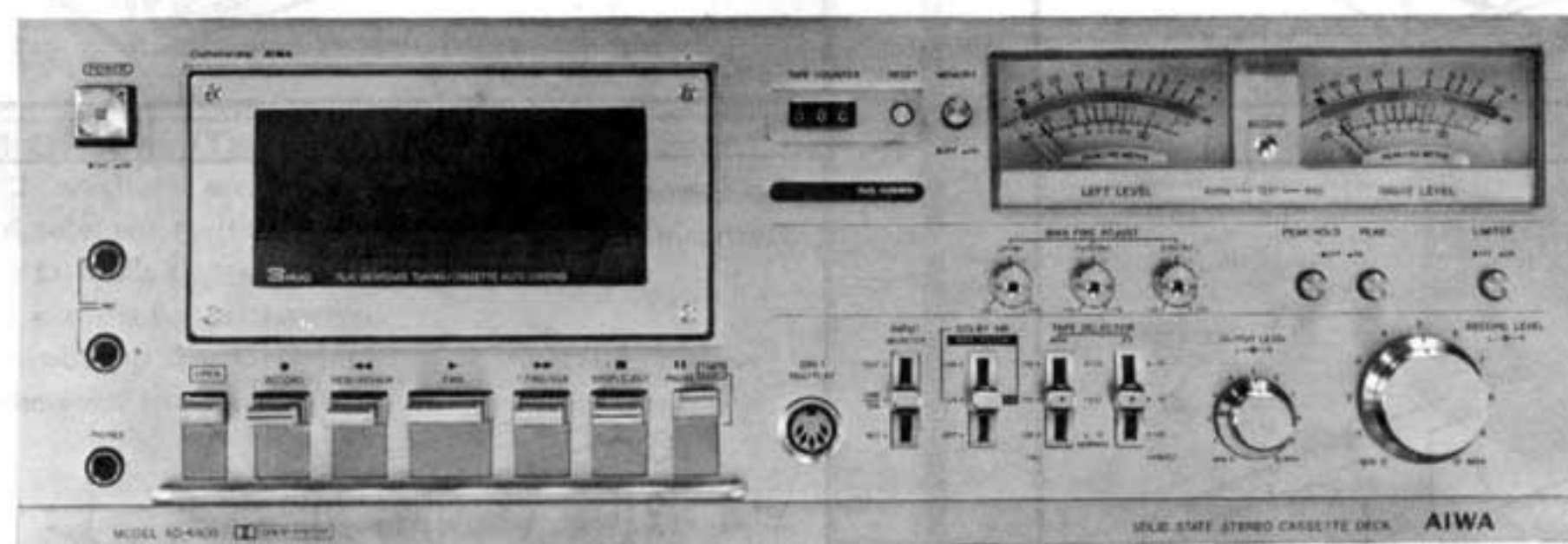

Set using ISO screws

DATE OF ISSUE 25/9/1977

SPECIFICATIONS

Semiconductors:	8 IC's, 86 transistors, 10 FETs, 65 diodes & 4 LED's	Bias frequency:	100 kHz \pm 10 kHz
Power source:	AD-6800H,EE: AC 110~120 V/ 220~240 V (switchable) 50/60 Hz AD-6800UK: AC 120 V/240 V (switchable) 50/60 Hz	Frequency response:	LH-tape, 20~16 kHz (-10 dB) 30~15 kHz (+2/-3 dB) Fe-Cr tape, 20~19 kHz (-10 dB) 30~17 kHz (+2/-3 dB) CrO ₂ tape, 20~18 kHz (-10 dB) 30~16 kHz (+2/-3 dB)
Power consumption:	20W	Motor:	(at Dolby off, Rec./pb) 38 pulse FG servo motor
Dimensions:	450(W) x 162(H) x 335(D) mm	Head:	Ferrite guard head (FGH)
Weight:	10 kg	Input:	MIC: Max. input sensitivity 0.25 mV (200 ohms ~ 10 k-ohms suitable)
Track system:	4-track 2-channel stereo	LINE IN:	Max. input sensitivity 50 mV (More than 50 k-ohms)
Tape speed:	4.76 cm/sec. \pm 1%	DIN:	Max. input sensitivity 0.1 mV/k-ohms (3 k-ohms)
Wow & flutter:	0.1% (According to DIN 45 500) 0.05% (WRMS) at pB	Output:	LINE OUT: Standard output level 0.775 V (0 VU) Optimum load impedance more than 50 k-ohms
Automatic shut-off: action time	3 \pm 2 sec.	DIN:	Standard output level 0.775 V (0 VU) Optimum load impedance more than 50 k-ohms
Pinch roller pressure:	520 \pm 40 g	PHONES:	Load impedance 8 ohms to 150 ohms
Take-up torque:	50 \pm 10 g-cm		
FF & rewind torque:	110 \pm 50 -10 g-cm		
FF time:	95 \pm 10 sec (w/C-60 cassette)		
Rewind time:	100 \pm 10 sec (w/C-60 cassette)		
Playback output: (TTA-161)	1.1 \pm 0.05 V (LINE/DIN)		
Playback noise:	Less than 4.5 mV (LH) Less than 3.0 mV (Fe-Cr, CrO ₂) 0 VU \pm 0.5 dB (LINE/DIN)		
Rec./pb output: (400 Hz 0 VU)			
Rec./pb distortion: (400 Hz 0 VU)	Less than 1.5% (LH) Less than 1.5% (Fe-Cr) Less than 3.0% (CrO ₂)		
Rec./pb S/N: (400 Hz 0 VU) (Un-Weighted)	More than 43/45 dB (LH, DOLBY OFF/ON) More than 45/48 dB (Fe-Cr, DOLBY OFF/ON) More than 45/48 dB (CrO ₂ , DOLBY OFF/ON)		
Channel separation:	More than 28 dB (at 1 kHz 0 VU)		
Cross talk:	More than 65 dB (at 1 kHz 0 VU)		
Erasing ratio:	More than 60 dB (400 Hz +10 VU)		
VU meter display error:	\pm 0.5 dB (at 400 Hz 0 VU + 3 dB)		
Peak meter display error:	+10 VU \pm 1 dB 0 VU \pm 0.5 dB		
(400 Hz, 0 VU: 0.775 V)	-10 VU \pm 1 dB -20 VU \pm 2 dB -30 VU \pm 1 dB		

- Specifications and external appearance are subject to change without notice due to product improvement.
- Dolby Noise Reduction System is licensed from Dolby Laboratories Incorporated.
- The name "Dolby" and the "Double D" symbol are trademarks of Dolby Laboratories Incorporated.

DISASSEMBLY INSTRUCTIONS

To Remove Case
Remove 5 screws.

To Remove Back Cover
Remove 6 screws.

To Remove Power/OSC Circuit Board
Remove 2 screws.

To Remove Level Meter
1) Remove 3 screws and 4 nuts.

To Remove Front Panel
Remove 6 screws and knobs.

To Remove Meter Amp./Test Head Amp. Circuit Board

- 1) Remove 2 washers and nuts of the volume shafts.
- 2) Remove 4 selector switch screws.
- 3) Remove 3 DIN jack screws.
- 4) Remove 2 circuit board screws.

Note: When removing the DIN jack, pull the DIN holder in the direction indicated by the arrow and remove.

To Remove Filter Circuit Board
Remove 2 screws.

To Remove REC/LED Circuit Board
Remove 2 screws.

To Remove Bias Circuit Board
Remove 3 nuts.

To Remove Main Circuit Board
Remove 6 screws and 4 connectors

Note: The 3 1P connectors are located in different connecting positions according to the model since they are used to adjust the bias current. Therefore, check the connecting positions and always connect to their original positions when re-connecting.

To Remove Switch Circuit Board

- 1) Remove 3 push rod stoppers and draw in the direction indicated by the arrows.
- 2) Remove 4 screws and connector, and the switch circuit board can be removed if it is drawn in the direction indicated by the arrow.

To Remove Stop Muting Circuit Board
Remove mounting screw.

To Remove Room Lamp Circuit Board
Lift up the right side of the room lamp circuit board, and draw in the direction indicated by the arrow.

To Remove Relay Circuit Board
Remove 2 screws and 2 nylon rivets.

To Remove Mechanism
Remove 4 screws and counter belt.

To Remove Motor Circuit Board
Remove 2 screws.

To Remove CrO₂ Auto Circuit Board
Remove mounting screws.

To Remove Auto-Stop/Timer Start Circuit Board.
Remove 4 screws.

EXPLODED VIEW-1

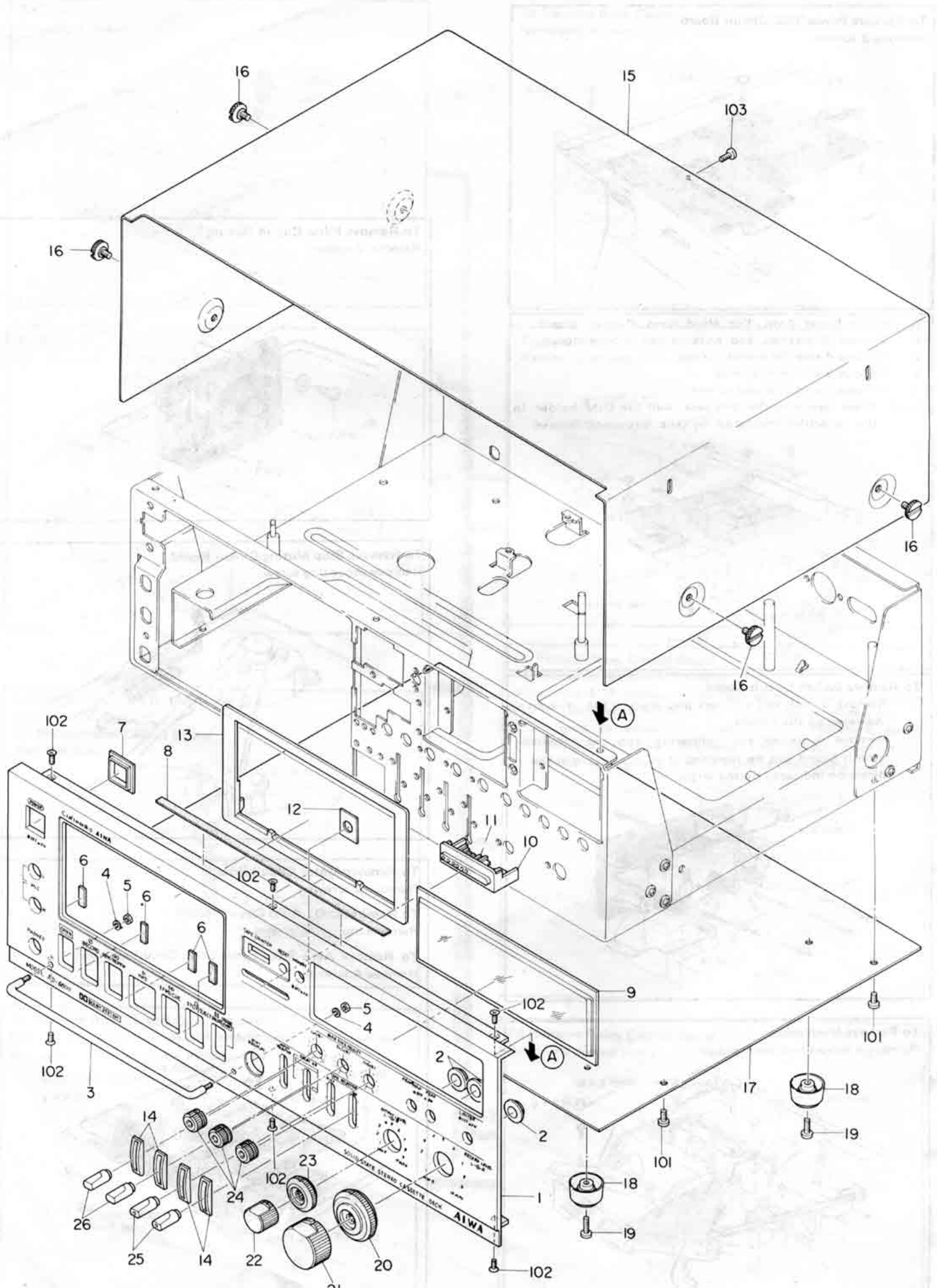

PARTS LIST

MECHANICAL PARTS

■ * mark in this parts list shows exclusive part (which is used) for only Model AD-6800.

Ref. No.	Part No.	Part No. Changed to	Description	Common Model	Q'ty
1~14	09-047-094-01		Panel Assembly (H model only)		
1~14	09-047-095-01		Panel Assembly (EE, UK model only)		
1-1a	82-387-032-01		Front panel (H model only)	*	1
1-1b	82-387-061-01		Front panel (EE, UK model only)	*	1
1-2	82-387-016-01		Guide B, Push switch button	*	3
1-3	82-387-022-01		Bar, Push button	*	1
1-4	82-421-306-01		SW-3		2
1-5	87-319-018-01		N-3		2
1-6	82-387-055-01		Spacer A	*	4
1-7	82-380-026-01		Guide, Power button	AD-6500	1
1-8	82-473-273-01		Spacer, Top panel	AD-6500	1
1-9	82-387-023-01		Window B, Meter	*	1
1-10	82-380-024-01		Panel, Tape running	AD-6500	1
1-11	82-380-025-01		Window, Tape running	AD-6500	1
1-12	82-380-075-01		Brind himeron, Memory button	AD-6500	1
1-13	82-387-019-01		Front panel B	*	1
1-14	82-387-071-01		Guide, Lever switch	*	4
1-15	82-387-069-01		Top panel	*	1
1-16	82-473-047-01		Screw, Top panel	AX-7500	4
1-17	82-380-004-01		Bottom lid	AD-6500	1
1-18	87-085-141-01		Leg		4
1-19	87-263-171-01		V + 4-10		4
1-20	82-387-012-01		Volume knob B, REC	*	1
1-21	82-387-053-01		Volume knob A ass'y, REC	*	1
1-22	82-387-056-01		Volume knob A ass'y, Playback	*	1
1-23	82-387-014-01		Volume knob B, Playback	*	1
1-24	82-387-018-01		Bias volume knob	*	3
1-25	82-387-046-01		Knob ass'y (Red)	*	2
1-26	82-387-029-01		Knob ass'y	*	2

Ref. No.	Part No.	Description	Q'ty
1-101	87-253-094-01	U + 3-6	6
1-102	87-233-093-01	Q + 3-5	6

Ref. No.	Part No.	Description	Q'ty
1-103	87-481-402-01	UT ₂ + 3-8(Black)	1

EXPLODED VIEW-2

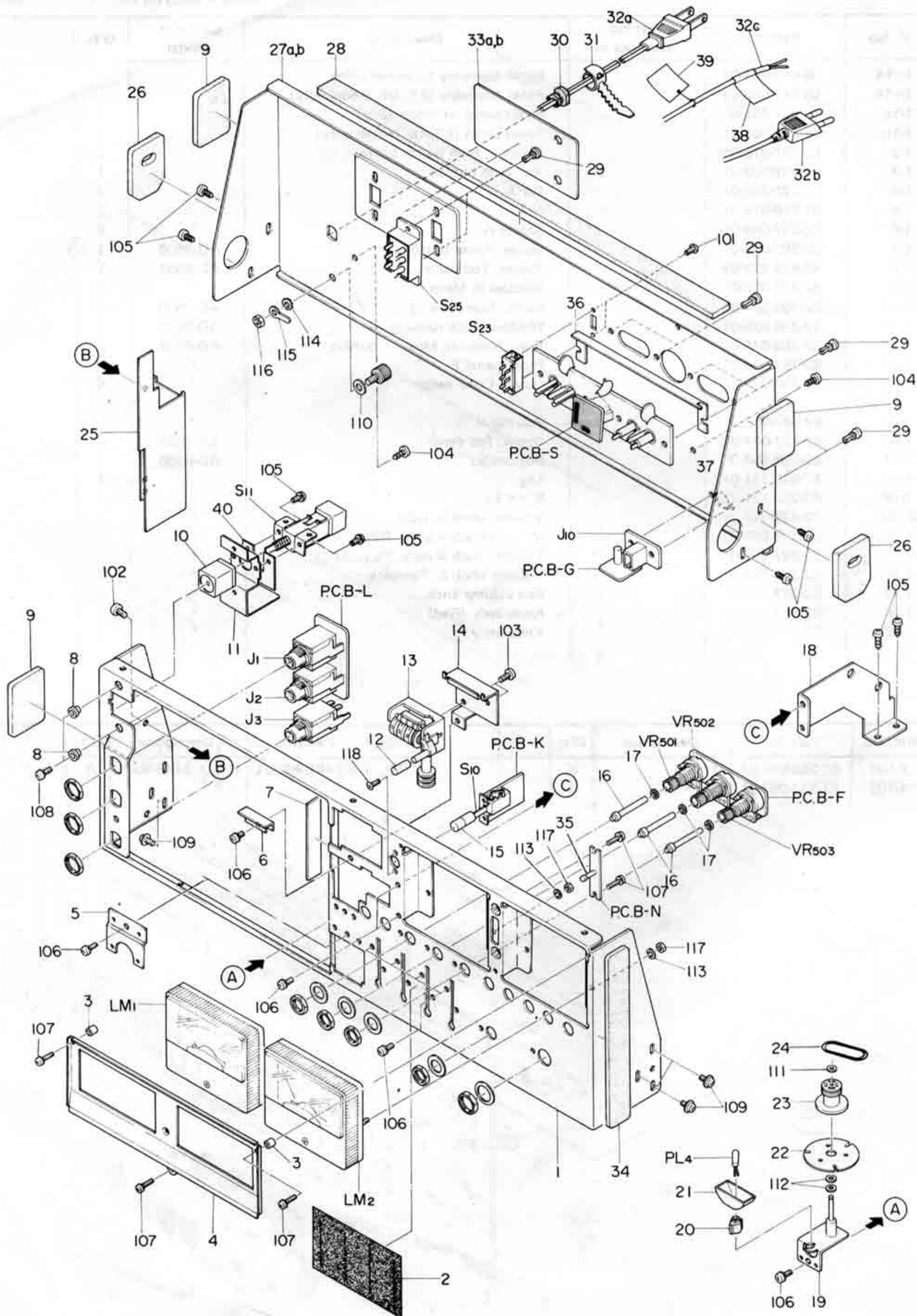

Ref. No.	Part No.	Part No. Changed to	Description	Common Model	Q'ty
2-1	82-387-206-11		Front chassis ass'y	*	1
2-2	82-387-037-01		Cover, Lever switch	*	1
2-3	82-387-025-01		Collar, Meter name plate	*	2
2-4	82-387-021-01		Name plate, Meter	*	1
2-5	82-380-355-01		Holder, DIN jack	AD-6500	1
2-6	82-380-367-01		Cover, Front chassis	AD-6500	1
2-7	82-380-375-01		Cover B, Front chassis	AD-6500	1
2-8	82-380-292-01		Collar, AC holder	AD-6500	2
2-9	82-473-247-01		Spacer B, Side panel	AX-7500	3
2-10	82-387-049-01		AC button B ass'y	*	1
2-11	82-380-298-01		Holder, AC switch	AD-6500	1
2-12	82-432-036-01		Counter button	TPR-212	1
2-13	87-040-080-01		Counter		1
2-14	82-387-215-01		Holder, Counter	*	1
2-15	82-387-051-01		Memory button B ass'y	*	1
2-16	82-387-027-01		Guide, Light	*	3
2-17	82-387-036-01		M cushion, Light guide	*	3
2-18	82-387-214-01		Auxiliary plate	*	1
2-19	82-387-207-01		Tape running holder ass'y	*	1
2-20	82-380-344-01		Lamp bushing B	AD-6500	1
2-21	82-380-280-01		Reflector mirror	AD-6500	1
2-22	82-380-372-01		Shadow plate B	AD-6500	1
2-23	82-380-282-01		Shadow pulley	AD-6500	1
2-24	82-380-440-01		Belt C, Counter	AD-6500	1
2-25	82-387-680-01		Shield plate, MIC	*	1
2-26	82-473-245-01		Spacer A, Side panel	AX-7500	2
2-27a	82-387-064-01		Rear panel (H, UK model only)	*	1
2-27b	82-387-063-01		Rear panel (EE model only)	*	1
2-28	82-380-439-01		Spacer, Rear panel	AD-6500	1
2-29	87-085-102-01		Nylon rivet		8
2-30	87-085-101-01		Cord bushing (H model only)		1
2-31	87-058-023-01		Cord binder		1
2-32a	87-034-826-01		AC power cord (H model only)		1
2-32b	87-034-835-01		AC power cord (EE model only)		1
2-32c	87-034-872-01		AC power cord (UK model only)		1
2-33a	82-387-033-01		Name plate, Spec. (H model only)	*	1
2-33b	82-387-065-01		Name plate, Spec. (EE model only)	*	1
2-33c	82-387-066-01		Name plate, Spec. (UK model only)	*	1
2-34	82-380-412-01		Cushion, Top panel	AD-6500	1
2-35	82-387-290-01		Collar, REC LED	*	1
2-36	82-386-629-01		Shield plate, Jack	AD-1250	1
2-37	82-387-273-01		Holder, Jack	*	1
2-38	87-056-008-01		Label, AC power cord (UK model only)		1
2-39	87-056-014-01		Tag, Main voltage (UK model only)		1
2-40	82-379-701-01		Insulation plate A	AD-1800	1

Ref. No.	Part No.	Description	Q'ty
2-101	87-267-035-01	V + 2-6(Black)	2
2-102	87-253-092-01	U + 3-4	2
2-103	87-253-094-01	U + 3-6	4
2-104	87-481-402-01	UT ₂ + 3-8(Black)	3
2-105	87-343-095-01	UT ₂ + 3-5	6
2-106	87-480-092-01	VS + 3-4	7
2-107	87-257-035-01	VS + 2-6	5
2-108	87-480-094-01	VS + 3-6	2
2-109	87-510-095-01	VTF + 3-8	6

Ref. No.	Part No.	Description	Q'ty
2-110	87-410-325-01	W4-10-1.0	1
2-111	87-081-464-01	PW1.8	1
2-112	87-081-319-01	TW2.3-8-0.2	2
2-113	87-421-306-01	SW3	4
2-114	87-433-906-01	WTIE-4	1
2-115	87-450-416-01	LB-6	1
2-116	87-391-024-01	N-4	1
2-117	87-319-018-01	N-3	5
2-118	87-233-033-01	Q + 2-4	2

EXPLODED VIEW-3

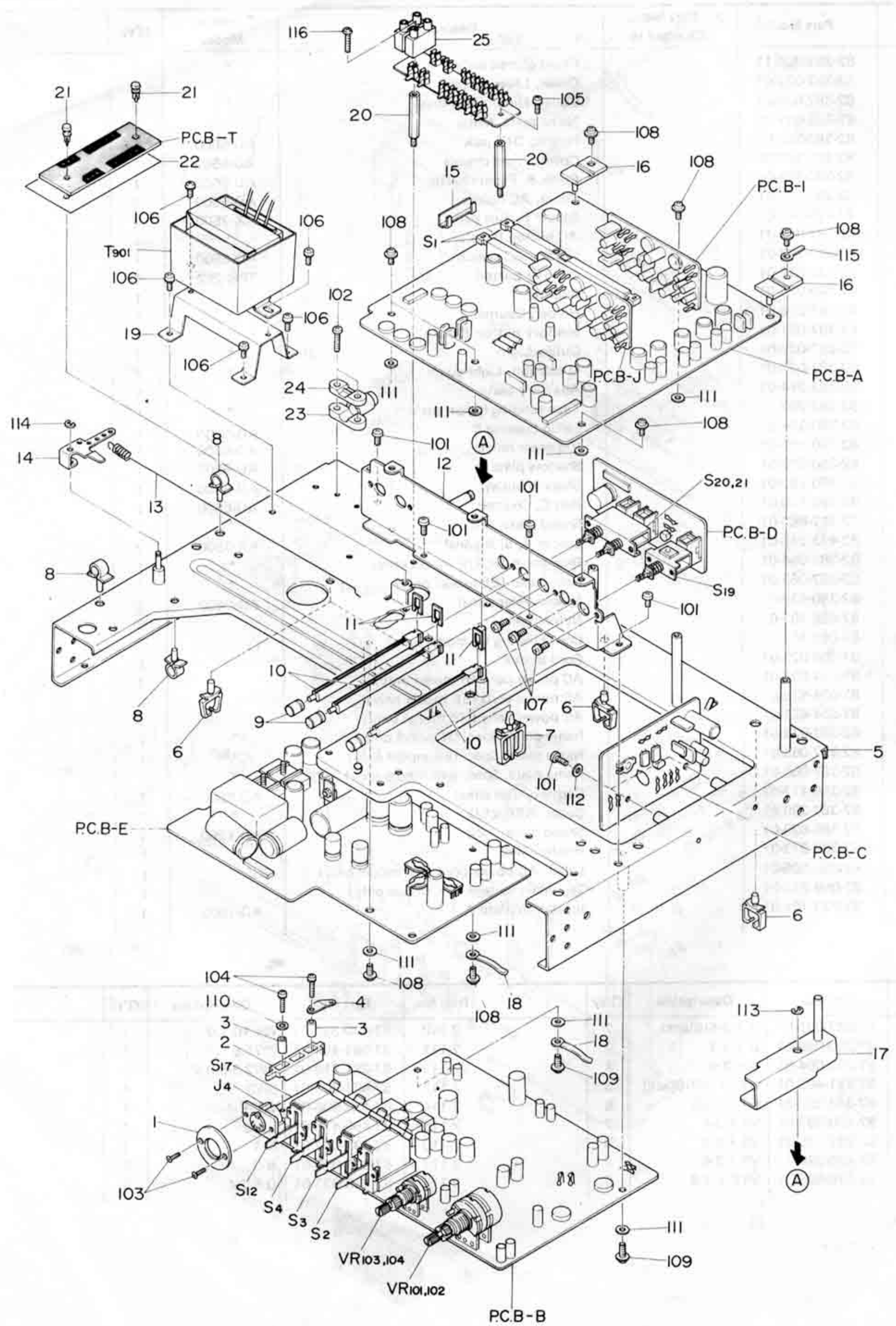

Ref. No.	Part No.	Part No. Changed to	Description	Common Model	Q'ty
3-1	82-380-073-01		Cover, DIN	AD-6500	1
3-2	82-387-244-01		DIN selector pole	*	1
3-3	82-387-245-01		Collar, DIN selector pole	*	2
3-4	82-387-248-01		Spacer, Erath	*	1
3-5	82-387-201-01		Amp. chassis ass'y	*	1
3-6	87-064-038-01		Wire clip A		5
3-7	87-064-051-01		Wire clip F		1
3-8	87-064-050-01		Wire clip E		3
3-9	82-387-017-01		Push switch button	*	3
3-10	82-387-218-01		Push rod	*	3
3-11	82-385-383-01		Stopper, Rod	AD-6300	3
3-12	82-387-217-01		Plate, Circuit holder	*	1
3-13	82-387-216-01		Spring, REC	*	1
3-14	82-374-246-01		Relay lever, REC	AD-1200	1
3-15	82-372-414-01		Pressure plate, REC switch		1
3-16	87-064-056-01		Hinge, Circuit board		2
3-17	82-387-211-01		REC lever A ass'y	*	1
3-18	87-038-039-01		Wire binder		2
3-19	82-380-447-01		Holder, Power transformer	AD-6500	1
3-20	82-387-310-01		Brass post B	*	2
3-21	87-085-102-01		Nylon rivet		2
3-22	82-387-691-01		Insulation plate	*	1
3-23	87-085-094-01		Holder A, AC power cord (EE, UK model only)		1
3-24	87-085-095-01		Holder B, AC power cord (EE, UK model only)		1
3-25	87-033-145-01		Relay Terminal (EE model only)		1

Ref. No.	Part No.	Description	Q'ty
3-101	87-253-092-01	U + 3-4	6
3-102	87-253-099-01	U + 3-15	2
3-103	87-233-035-01	Q + 2-6	2
3-104	87-480-076-01	VS + 2.6-12	2
3-105	87-480-094-01	VS + 3-6	1
3-106	87-480-169-01	VS + 4-6	6
3-107	87-480-092-01	VS + 3-4	4
3-108	87-470-093-01	VW + 3-5	9

Ref. No.	Part No.	Description	Q'ty
3-109	87-490-095-01	VWS + 3-8	2
3-110	87-410-315-01	W3-8-0.5	1
3-111	87-081-084-01	FW3-10-0.5	8
3-112	87-081-013-01	FW2.6-7.5-0.5	2
3-113	87-441-011-01	STE-4	1
3-114	87-441-006-01	STE-2.3	1
3-115	87-450-416-01	LB-6	1
3-116	87-253-102-01	U + 3-20	1

EXPLODED VIEW-4

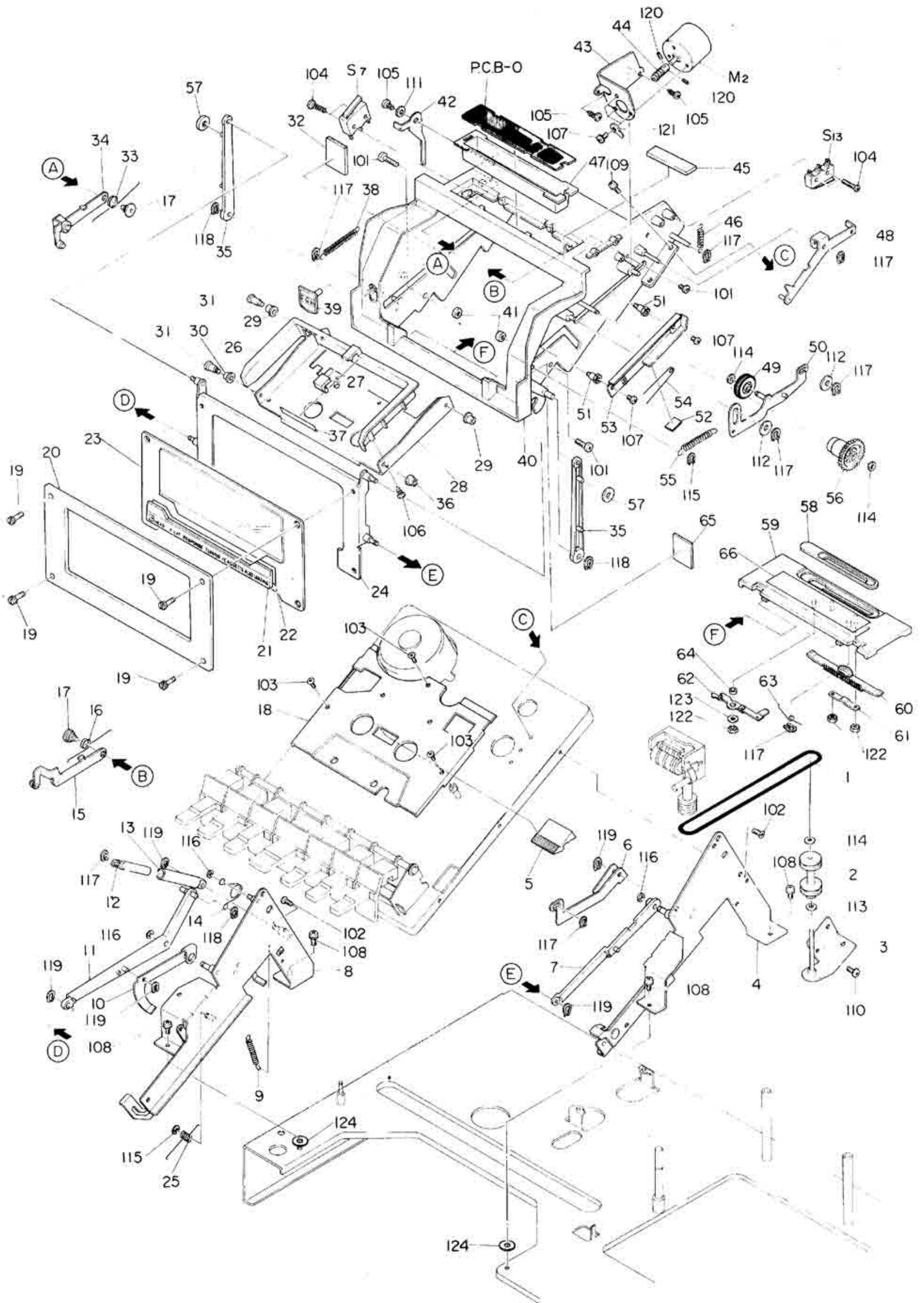

Ref. No.	Part No.	Part No. Changed to	Description	Common Model	Q'ty
4-1	82-380-441-01		Belt D, Counter		
4-2	82-380-338-01		Relay pulley B	AD-6500	1
4-3	82-380-312-01		Relay holder B ass'y	AD-6500	1
4-4	82-380-223-01		Chassis holder ass'y, Right	AD-6500	1
4-5	82-380-378-01		Tape window	AD-6500	1
4-6	82-380-287-01		Lever, Cassette lid open	AD-6500	1
4-7	82-380-269-01		Lever R, Cassette lid	AD-6500	1
4-8	82-380-226-01		Chassis holder ass'y, Left	AD-6500	1
4-9	82-387-225-01		Spring, Cassette lid open lever	*	1
4-10	82-380-274-01		Relay lever E	AD-6500	1
4-11	82-380-270-01		Lever L, Cassette lid	AD-6500	1
4-12	82-380-397-01		Shaft A, Damper	AD-6500	1
4-13	82-380-398-01		Shaft B, Damper	AD-6500	1
4-14	82-380-304-01		Plate spring, Cassette lid open	AD-6500	1
4-15	82-380-210-01		Cassette holder plate ass'y, Right	AD-6500	1
4-16	82-380-362-01		Spring, Cassette holder plate	AD-6500	1
4-17	82-380-215-01		Shaft, Holder plate	AD-6500	2
4-18	82-380-065-01		Back plate B	AD-6500	1
4-19	82-387-045-01		Screw 2-6	*	4
4-20	82-387-042-01		Panel B, Cassette lid	*	1
4-21	82-387-044-01		Name plate, Cassette lid	*	1
4-22	82-387-048-01		Adhesive label	*	1
4-23	82-387-043-01		Window, Cassette	*	1
4-24	82-387-258-01		Cassette lid holder B ass'y	*	1
4-25	82-380-356-01		Spring, Relay lever	AD-6500	1
4-26	82-380-438-01		Cover, Cassette-up plate	AD-6500	1
4-27	82-380-291-01		Rubber, Cassette holder	AD-6500	1
4-28	82-380-436-01		Cassette-up plate	AD-6500	1
4-29	82-380-289-01		Collar A, Cassette-up plate	AD-6500	2
4-30	82-380-448-01		Collar B, Cassette-up plate	AD-6500	1
4-31	82-380-359-01		Shaft B, Cassette-up plate	AD-6500	2
4-32	82-380-449-01		Rubber cushion, Left	AD-6500	1
4-33	82-380-416-01		Spring B, Cassette holder plate	AD-6500	1
4-34	82-380-221-01		Cassette holder plate ass'y, Left	AD-6500	1
4-35	82-380-271-01		Lever A, Cassette lid	AD-6500	2
4-36	82-380-462-01		Collar C, Cassette-up plate	AD-6500	1
4-37	82-380-375-01		Cover B	AD-6500	1
4-38	82-380-305-01		Return spring, Cassette-up plate	AD-6500	1
4-39	82-387-035-01		FGH Badge	*	1
4-40	82-380-391-01		Cassette-up guide ass'y	AD-6500	1
4-41	82-387-263-01		Collar, Head cover	*	2
4-42	82-380-390-01		Switch pressure plate B	AD-6500	1
4-43	82-380-389-01		Holder D, Motor	AD-6500	1
4-44	82-380-361-01		Warm gear	AD-6500	1
4-45	82-380-457-01		Stopper rubber, Cassette-up plate	AD-6500	1
4-46	82-272-326-01		FR spring	*	1
4-47	82-387-026-01		Cover, Lamp	*	1
4-48	82-380-261-01		Switch pressure plate ass'y	AD-6500	1
4-49	82-380-250-01		Relay idler ass'y	AD-6500	1
4-50	82-380-257-01		Idler lever ass'y	AD-6500	1
4-51	82-380-358-01		Shaft A, Cassette-up plate	AD-6500	2
4-52	82-387-274-01		Spacer, Forward lever; Cassette-up	*	1
4-53	82-380-253-01		Forward lever ass'y, Cassette-up	AD-6500	1
4-54	82-380-363-01		Spring, Forward lever; Cassette-up plate	AD-6500	1
4-55	82-380-308-01		Spring, Relay idler	AD-6500	1
4-56	82-380-273-01		Gear, Cassette forward	AD-6500	1
4-57	82-387-224-01		Collar, Cassette lid lever	*	2
4-58	82-387-041-01		Name plate, Head cover	*	1
4-59	82-387-040-01		Head cover H	*	1
4-60	82-387-039-01		Rack, Slide	*	1
4-61	82-387-285-01		Stop pressure plat B	*	1
4-62	82-387-280-01		Stop lever ass'y	*	1
4-63	82-387-303-01		T spring, Stop lever	*	1
4-64	82-387-286-01		Collar, Stop lever	*	1
4-65	82-380-450-01		Rubber cushion, Right	AD-6500	1
4-66	82-387-271-01		Caution label, Head cover	*	1

Ref. No.	Part No.	Description	Q'ty	Ref. No.	Part No.	Description	Q'ty
4-101	87-257-033-01	U + 2-4	4	4-113	87-081-284-01	TW2.1-5-0.3	1
4-102	87-233-094-01	Q + 3-4	4	4-114	87-081-464-01	PW1.8-5-0.5	3
4-103	87-239-033-01	Q + 2-4(Black)	3	4-115	87-441-006-01	STE-2.3	1
4-104	87-341-037-01	UT ₁ + 2.10	4	4-116	87-441-009-01	STE-3	3
4-105	87-343-072-01	UT ₂ + 2.6-5	3	4-117	87-442-003-01	STP-3	11
4-106	87-323-034-01	QT ₂ + 2.5	4	4-118	87-442-004-01	STP-4	3
4-107	87-480-071-01	VS + 2.6-4	4	4-119	87-441-008-01	STE-2.5	5
4-108	87-480-094-01	VS + 3-6	4	4-120	87-374-032-01	SS2-3	2
4-109	87-480-093-01	VS + 3-5	4	4-121	87-450-412-01	LB-2	1
4-110	87-480-092-01	VS + 3-4	2	4-122	87-391-006-01	N-2	3
4-111	87-410-311-01	W2.6-7.5-0.5	1	4-123	87-410-305-01	W2-6-0.4	1
4-112	87-081-260-01	W4-10-0.4	2	4-124	87-410-334-01	W6-1.4-0.6	2

EXPLODED VIEW-5

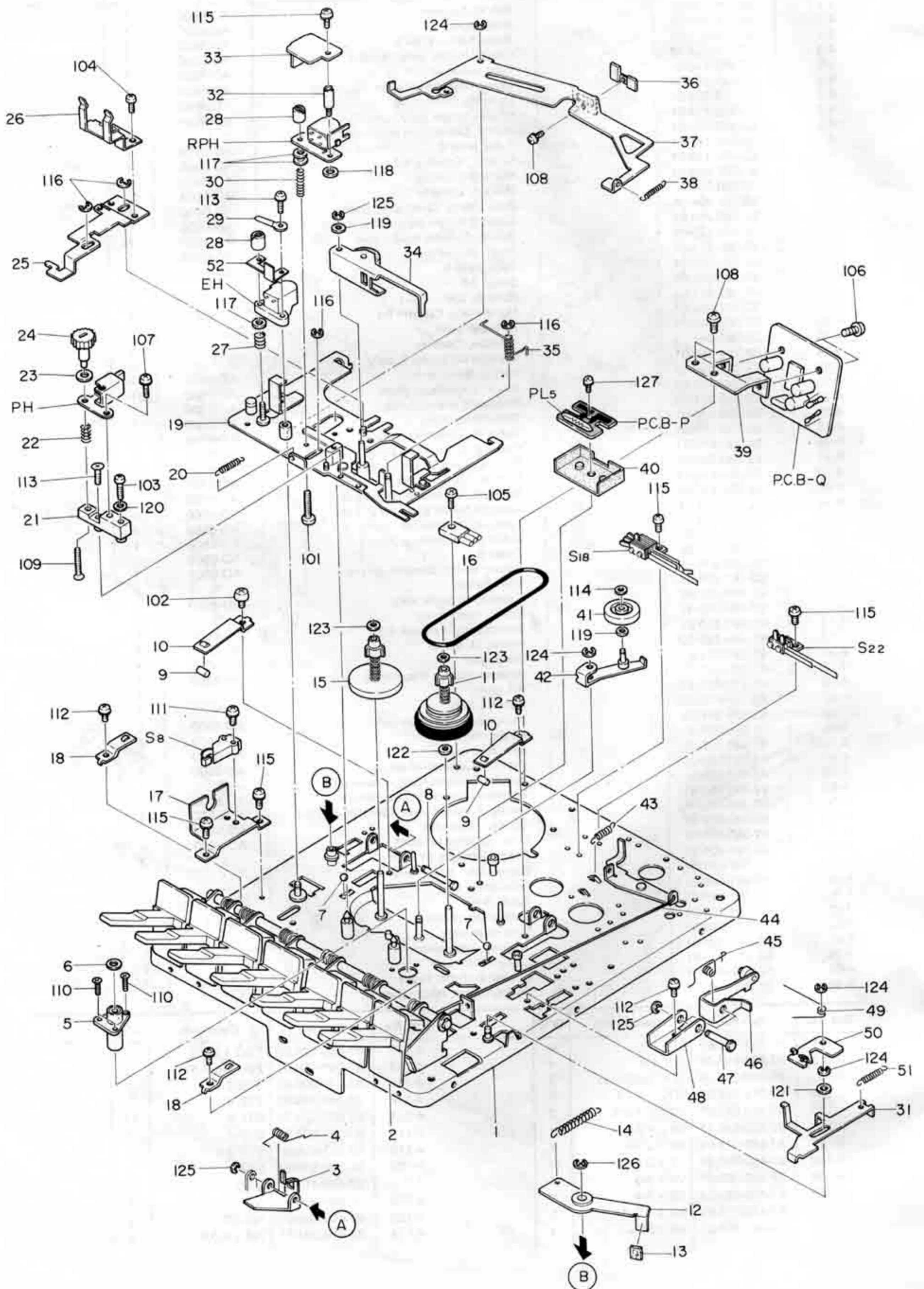

Ref. No.	Part No.	Part No. Changed to	Description	Common Model	Q'ty
5-1	82-387-287-01		Chassis ass'y	*	1
5-2	82-301-201-01		Push switch ass'y		1
5-3	82-380-351-01		Record-blocking lever B	AD-6500	1
5-4	82-371-356-01		Spring, blocking lever		1
5-5	82-370-253-01		Shaft bearing ass'y		1
5-6	82-283-351-01		Poly-slider washer		1
5-7	82-215-341-01		Steel ball 3/32		2
5-8	82-370-306-01		Shaft, blocking lever		1
5-9	82-603-305-01		Roller, 2.5φ		2
5-10	82-272-350-01		Plate spring, Head base holder		2
5-11	82-387-202-01		Take-up reel platform ass'y	*	1
5-12	82-387-296-01		Back tension lever ass'y	*	1
5-13	82-387-299-01		Felt, Back tension	*	1
5-14	82-387-300-01		Spring-E, Back tension	*	1
5-15	82-384-206-01		Rewind reel platform ass'y		1
5-16	82-463-219-01		Belt, Counter	TPR-900	1
5-17	82-370-336-01		Holder, Switch		1
5-18	82-387-305-01		Plate spring B, Actuating chassis	*	2
5-19	82-387-227-01		Actuating chassis H ass'y	*	1
5-20	82-380-444-01		Spring B, Actuating lever	AD-6500	1
5-21	82-387-233-01		Base, Head	*	1
5-22	82-387-242-01		Spring, Head adjuster	*	1
5-23	82-387-292-01		G cushion	*	1
5-24	82-387-256-01		Gear ass'y	*	1
5-25	82-380-442-01		Actuating lever B	AD-6500	1
5-26	82-380-443-01		Plate spring B, Cassette holder B	AD-6500	1
5-27	82-387-277-01		Spring C, Erase head	*	1
5-28	82-380-403-01		Spring, Head adjuster	AD-6500	2
5-29	82-365-280-01		Wire holder		1
5-30	82-380-402-01		Spring, Head adjusting	AD-6500	1
5-31	82-370-291-01		Pause lever ass'y		1
5-32	82-387-249-01		Screw, Head cover	*	1
5-33	82-387-278-01		Head cover C	*	1
5-34	82-387-235-01		Pinch lever ass'y	*	1
5-35	82-374-278-01		Spring, Pinch lever	AD-1200	1
5-36	82-370-408-01		Brake		1
5-37	82-370-430-01		Brake arm		1
5-38	82-370-419-01		Spring, Brake arm		1
5-39	82-387-668-01		Holder, Motor circuit board	*	1
5-40	82-380-379-01		Cushion, Tape lamp	AD-6500	1
5-41	82-272-270-01		FF idler		1
5-42	82-272-291-01		Rewind lever ass'y		1
5-43	82-380-407-01		Spring, Switch pressure plate	AD-6500	1
5-44	82-370-321-01		Bar, Relay		1
5-45	82-380-394-01		Spring, Cassette-up lever	AD-6500	1
5-46	82-380-238-01		Eject lever ass'y	AD-6500	1
5-47	82-380-296-01		Shaft, Eject lever B	AD-6500	1
5-48	82-380-286-01		Eject lever B	AD-6500	1
5-49	82-370-264-01		Plate spring, Lock plate		1
5-50	82-380-373-01		Lock plate B	Ad-6500	1
5-51	82-370-314-01		Spring, Pause lever		1
5-52	82-387-302-01		Stop pressure plate C	*	1

Ref. No.	Part No.	Description	Q'ty	Ref. No.	Part No.	Description	Q'ty
5-101	87-263-039-01	V + 2-14	1	5-115	87-480-033-01	VS + 2-4	8
5-102	87-263-070-01	V + 2.6-3	2	5-116	87-441-006-01	STE-2.3	4
5-103	87-257-038-01	V + 2-12	1	5-117	87-410-305-01	W2-6-0.4	3
5-104	87-263-031-01	V + 2-2	2	5-118	82-410-312-01	W3-6-0.3	1
5-105	87-253-033-01	U + 2-4	1	5-119	87-081-036-01	TW2-5-0.5	2
5-106	87-253-092-01	U + 3-4	2	5-120	87-410-304-01	W2-4.3-0.4	1
5-107	87-257-033-01	U + 2-4	1	5-121	87-410-315-01	W3-8-0.2	1
5-108	87-253-071-01	U + 2.6-4	2	5-122	82-215-207-01	TW1.6-3.8-0.2	1
5-109	87-233-038-01	Q + 2-12	1	5-123	87-081-473-01	PW1.3	2
5-110	87-233-033-01	Q + 2-4	3	5-124	87-441-005-01	STE-2	4
5-111	87-480-036-01	VS + 2-8	2	5-125	87-441-003-01	STE-1.5	3
5-112	87-480-071-01	VS + 2.6-4	5	5-126	87-441-011-01	STE-4	1
5-113	87-257-035-01	VS + 2-6	2	5-127	87-480-073-01	VS + 2.6-6	1
5-114	87-081-464-01	PW1.8-5-0.5	1				



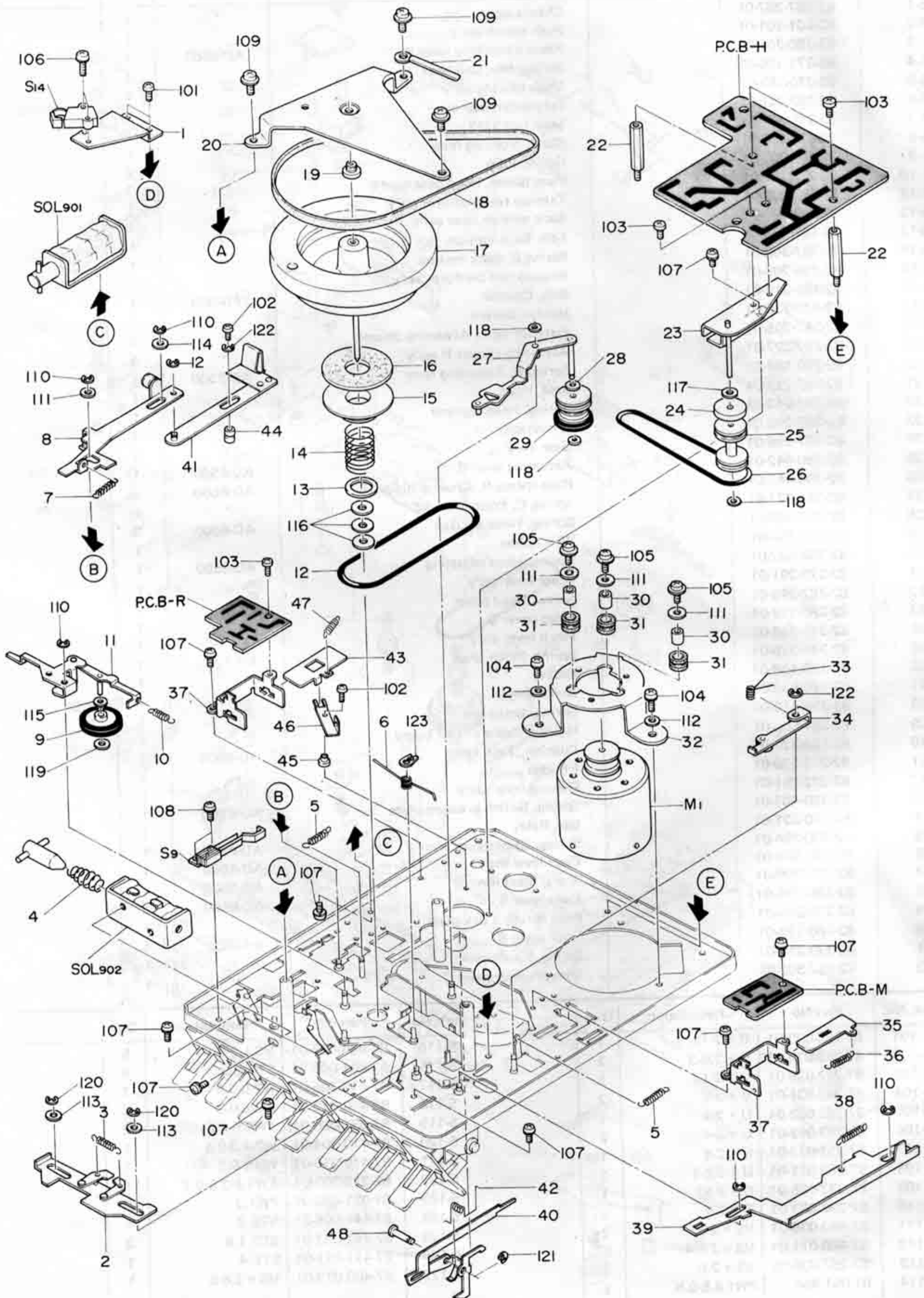











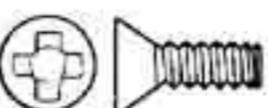

EXPLODED VIEW-6

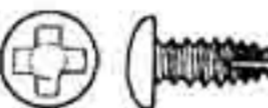

Ref. No.	Part No.	Part No. Changed to	Description	Common Model	Q'ty
6-1	82-380-348-01		Holder, Rewind switch	AD-6500	1
6-2	82-387-304-01		Main drive lever ass'y	*	1
6-3	82-272-326-01		FR spring		1
6-4	82-370-417-01		Spring, Plunger		1
6-5	82-380-459-01		Spring E, Actuating chassis	AD-6500	2
6-6	82-272-327-01		Shift spring		1
6-7	82-374-273-01		Spring, Stop lever	AD-1200	1
6-8	82-380-335-01		Stop lever C ass'y	AD-6500	1
6-9	82-272-372-01		Play idler ass'y		1
6-10	82-370-383-01		Spring, Play idler		1
6-11	82-370-391-01		Idler lever ass'y		1
6-12	82-380-399-01		FR belt B	AD-6500	1
6-13	82-374-285-01		Spring stop washer	AD-1200	1
6-14	82-380-395-01		Spring, Fly wheel	AD-6500	1
6-15	82-387-308-01		Flywheel pulley ass'y	*	1
6-16	82-387-254-01		Felt A, Flywheel	*	1
6-17	82-387-270-01		Flywheel C ass'y	*	1
6-18	82-387-262-01		Main belt B	*	1
6-19	82-272-335-01		Screw for thrust		1
6-20	82-387-279-01		Bearing plate, Flywheel	*	1
6-21	87-038-039-01		Wire dinder		1
6-22	82-387-219-01		Brass post A, Chassis	*	2
6-23	82-380-246-01		Relay holder ass'y	AD-6500	1
6-24	82-379-617-01		Ring magnet	AD-1800	1
6-25	82-380-285-01		Relay pulley	AD-6500	1
6-26	82-380-393-01		Belt, Relay	AD-6500	1
6-27	82-380-409-01		FR lever ass'y	AD-6500	1
6-28	87-081-464-01		PW 1.8-5-0.5		2
6-29	82-380-352-01		FR pulley ass'y	AD-6500	1
6-30	82-370-423-01		Collar, Motor		3
6-31	87-087-027-01		Rubber cushion		3
6-32	82-370-378-01		Holder, Motor		1
6-33	82-370-313-01		Spring, REC lock lever		1
6-34	82-370-347-01		REC lock lever ass'y		1
6-35	82-374-249-01		Switch auxiliary plate B	AD-1200	1
6-36	82-374-279-01		Return spring D	AD-1200	1
6-37	82-374-248-01		Switch holder C	AD-1200	2
6-38	82-272-424-01		Spring, REC lever		1
6-39	82-380-413-01		Lever, REC	AD-6500	1
6-40	82-380-421-01		CrO ₂ lever ass'y	AD-6500	1
6-41	82-380-425-01		Joint lever ass'y	AD-6500	1
6-42	82-380-429-01		Spring, CrO ₂ lever	AD-6500	1
6-43	82-380-431-01		Switch auxiliary plate C	AD-6500	1
6-44	82-380-432-01		Shaft, Joint lever	AD-6500	1
6-45	82-380-433-01		Shaft, CrO ₂ switch lever	AD-6500	1
6-46	82-380-434-01		Lever, CrO ₂ switch	AD-6500	1
6-47	82-380-435-01		Spring, Auxiliary plate C	AD-6500	1
6-48	82-370-305-01		Spindle shaft		1

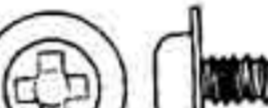
Ref. No.	Part No.	Description	Q'ty	Ref. No.	Part No.	Description	Q'ty
6-101	87-263-031-01	V + 2-2	2	6-113	87-410-323-01	W4-8-0.5	2
6-102	87-263-035-01	V + 2-6	2	6-114	87-410-317-01	W3-6-0.5	1
6-103	87-253-071-01	U + 2.6-4	5	6-115	87-081-036-01	TW2-5-0.5	2
6-104	87-480-092-01	VS + 3-4	3	6-116	87-081-319-01	TW2.3-8-0.2	3
6-105	87-480-074-01	VS + 2.6-8	3	6-117	87-081-284-01	TW.21-5-0.3	1
6-106	87-480-036-01	VS + 2-8	2	6-118	87-081-464-01	PW1.8-5-0.5	3
6-107	87-480-071-01	VS + 2.6-4	14	6-119	87-081-544-01	Poly-slider washer	1
6-108	87-480-033-01	VS + 2-4	2	6-120	87-441-010-01	STE-3.2	2
6-109	87-490-095-01	VWS + 3-8	3	6-121	87-441-005-01	STE-2	3
6-110	87-441-006-01	STE-2.3	5	6-122	87-441-006-01	STE-3	1
6-111	87-410-315-01	W3-8-0.5	5	6-123	87-442-003-01	STP-3	1
6-112	87-410-316-01	W3-8-0.8	3				

HARDWARE NOMENCLATURE

V:	Pan head screw		SS:	Set screw	
U:	Binding head screw		STP:	Powerful stop ring	
Q:	Flat countersunk head screw		STE:	E ring	
UT1:	Binding head tapping screw		W:	Washer	
UT2:	Binding head tapping screw		TW:	Tefron washer	
QT2:	Flat countersunk head tapping screw		FW:	Fiber washer	
VS:	Pan head screw with spring washer		PW:	Poly-slider washer	
VWS:	Pan head tapping screw with spring washer and washer		SW:	Spring washer	
VTF:	Flange and Pan head tapping screw		WTIE:	Crown washer	
VW:	Pan head tapping screw		N:	Nut	
			LB:	Lug terminal plate	

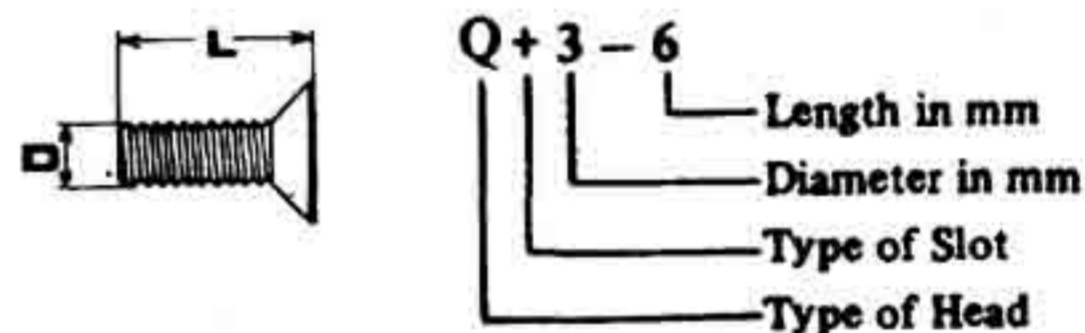
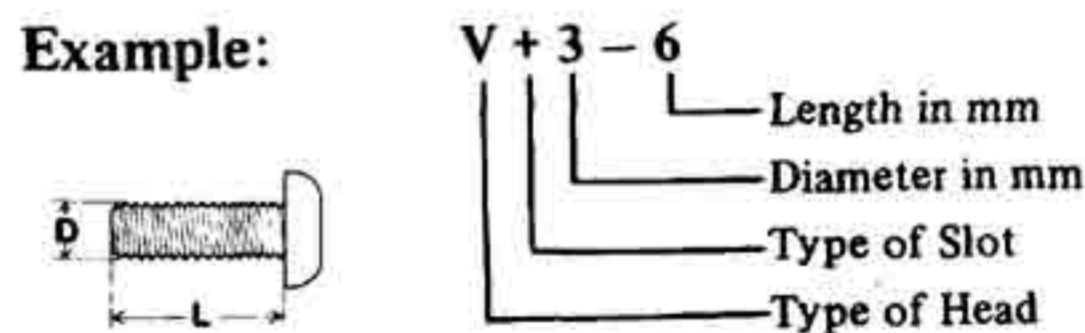

ACCESSORIES/PACKAGE

Ref. No.	Part No.	Part No. Changed to	Description	Common Model	Q'ty
1	82-387-856-01		Printed indiv., Packing	*	1
2	82-380-857-01		Cushion L, Printed indiv.	AD-6500	1
3	82-380-858-01		Cushion R, Printed indiv.	AD-6500	1
4	87-056-500-01		Curl stopper		2
5	87-051-146-01		Poly-vinyl sack (for case)		1
6	87-051-131-01		Poly-vinyl sack (for AC cord)		1
7	87-058-024-01		Head cleaning pole		1
8	86-944-613-01		Connection cord, CW-129K (H model only)		2
9	87-925-002-01		Connection cord, CW-115K (EE, UK model only)		1
10	80-291-645-01		Tape cassette, DMC-130A		1
11	87-056-009-01		Distributors list		1
12	87-056-512-01		Label, Cassette guide		2
13	87-056-571-01		Label, Cassette lid		1
14	87-051-171-01		Poly-vinyl sack (for instruction)		1
15a	82-387-912-01		Instructions booklet (H model only)	*	1
15b	82-387-915-01		Instructions booklet (EE model only)	*	1
15c	82-387-914-01		Instructions booklet (UK model only)	*	1

LEVEL DIAGRAM

● PLAYBACK

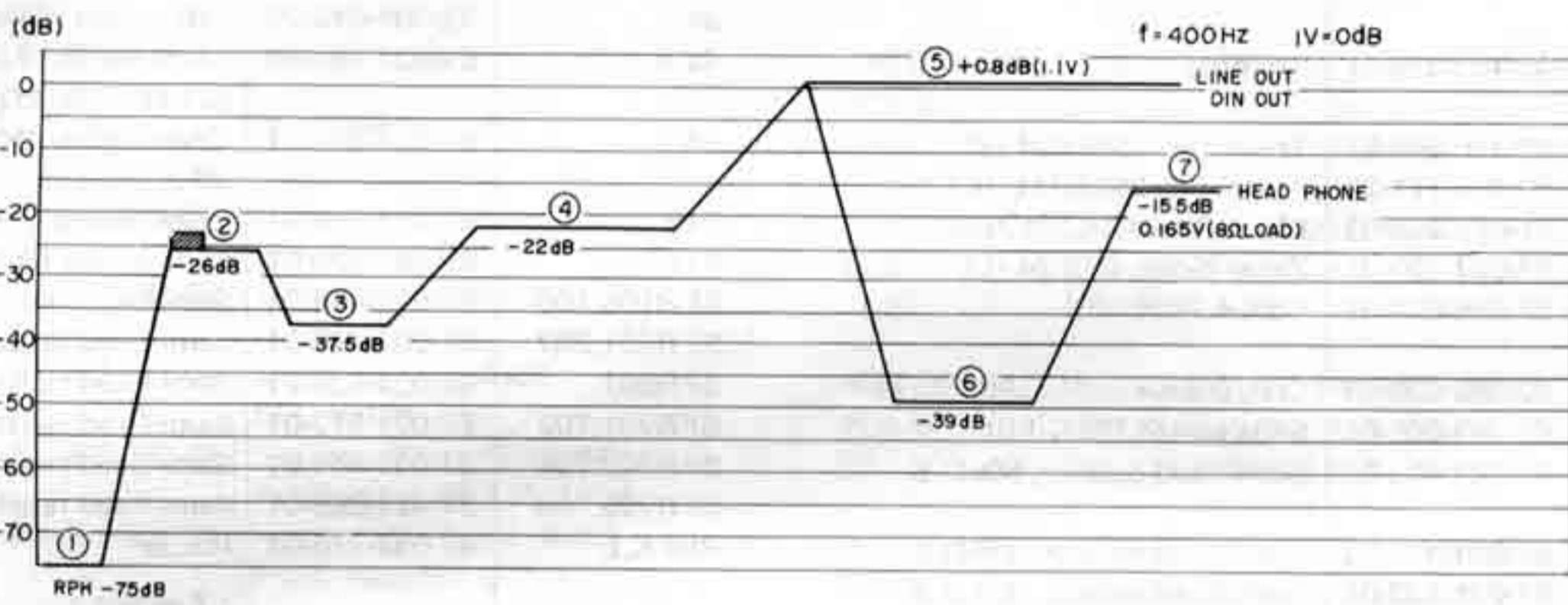
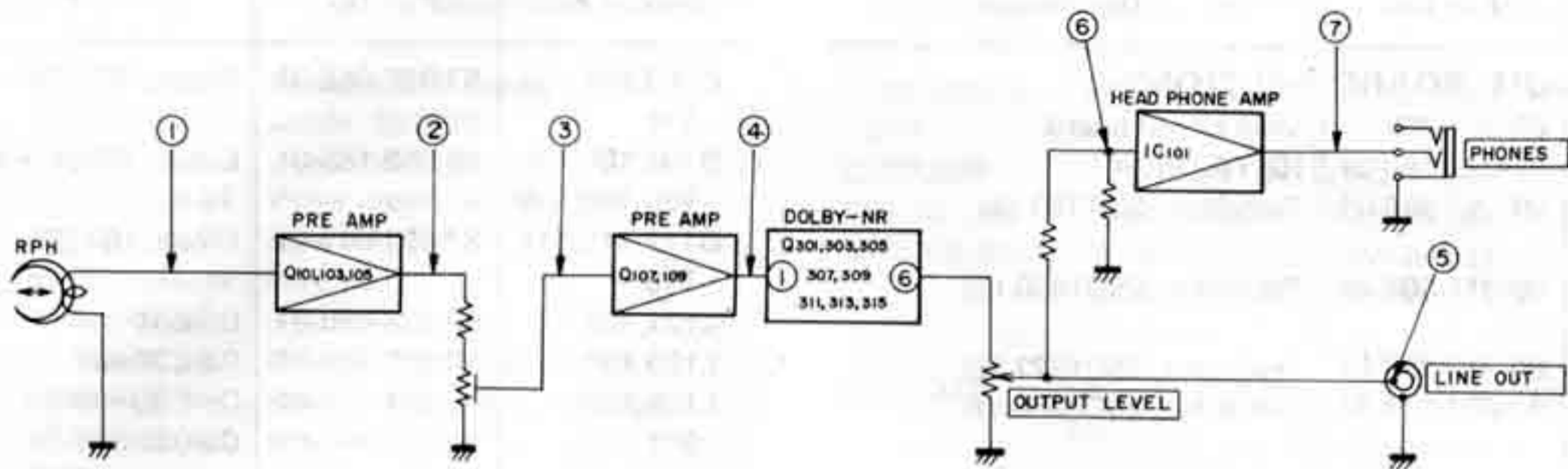

● RECORD

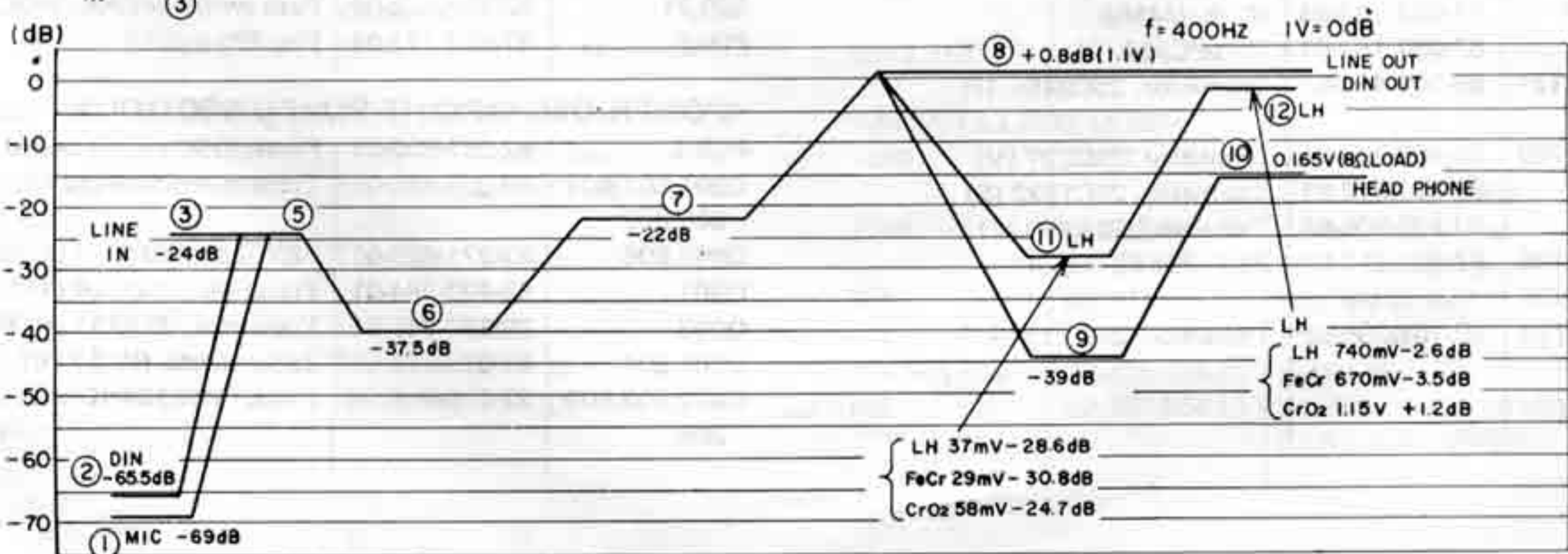
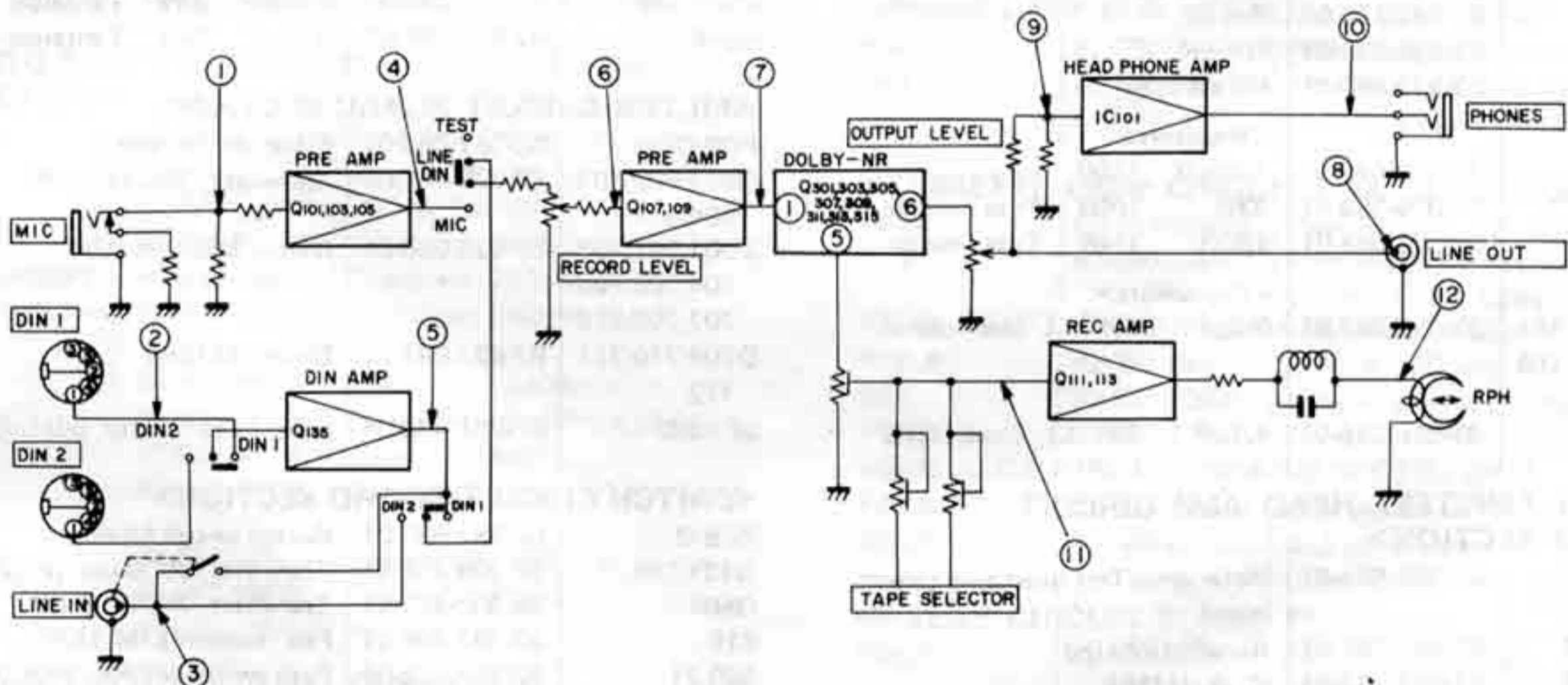

ELECTRICAL MAIN PARTS

Symbol No.	Part No.	Description
◀MAIN CIRCUIT BOARD SECTION▶		
PCB-A	82-387-708-01	Main circuit board
IC101,102	87-027-180-01	IC, TA7140AP
Q101,102,109 110	89-107-505-01	Transistor, 2SA750 (E)
Q103,104,107 108	89-314-005-01	Transistor, 2SC1400 (E)
Q105,106	89-312-222-01	Transistor, 2SC1222 (E)
Q111,112,113 114	87-027-111-01	Transistor, 2SC828A (R)
Q115,116,123 124,125,126 127,128,129 130,131,132 914	89-309-456-01	Transistor, 2SC945L (P)
Q133,134,139 140	89-402-275-01	Transistor, 2SD227 (V)
Q502	89-316-348-01	Transistor, 2SC1634 (B)
Q904	89-405-711-21	Transistor, 2SD571L (K)
D101,102	87-026-066-01	Diode, M8513A (O)
D921	87-027-223-01	Zener diode, 05Z-24 (L)
L107,108,109 110	82-385-634-01	Coil, 4.7mH
L111,112	82-385-636-01	Coil, 6.8mH
S1	82-387-605-01	Slide switch (REC/PB)
SFR101,102 103,104	87-021-429-01	Semi-fixed resistor, 50kΩ-B
SFR107,108	87-021-439-01	Semi-fixed resistor, 33kΩ-B
SFR109,110 111,112	87-021-422-01	Semi-fixed resistor, 22kΩ-B
PIN-B,E,F	87-032-774-01	Pin, 4P
PIN-G,H,I	87-032-775-01	Pin, 5P
PIN-A	87-032-776-01	Pin, 6P
PIN-C,D	87-032-778-01	Pin, 8P
	87-032-850-01	Pin ass'y, 6P
		<Resistors>
R145,146	82-379-675-01	7.32kΩ 1/4W
R508	87-029-380-01	33Ω 1/4W Fuse resistor
R905	87-029-058-01	180Ω 1/4W Fuse resistor
		<Capacitors>
C129,130,141 142,159,160 161,162	87-015-242-01	2.2μF 50V LL Electrolytic
C113,114	87-015-246-01	4.7μF 25V LL Electrolytic
◀METER AMP/TEST HEAD AMP CIRCUIT BOARD SECTION▶		
PCB-B	82-387-694-01	Meter amp/Test head amp circuit board
IC601,602	87-027-182-01	IC, μPC1023 (H)
IC701,703	87-027-183-01	IC, NJM4558
IC702	87-027-184-01	IC, μPC324 (C)
Q117,118,121 122,711	89-309-456-01	Transistor, 2SC945L (P)
Q119,120,709	89-402-275-01	Transistor, 2SD227 (V)
Q135,136	89-312-222-01	Transistor, 2SC1222 (E)
Q701,702	89-107-505-01	Transistor, 2SA750 (E)
Q703,704,705 706,707,708	87-027-217-01	FET, 2SK68 (M, J)
Q710,712,713	89-107-335-61	Transistor, 2SA733 (R·P)

Symbol No.	Part No.	Description
D103,104,113 114	87-026-066-01	Diode, M8513A (O)
D105,106,107 108,109,110	88-052-188-01	Diode, 1S188 (FM)
D111,112,115 116	87-027-097-01	Diode, 1S1555
L101,102	82-938-640-01	Coil, 10mH
L103,104	82-372-625-11	Coil, 36mH
L105,106	82-371-622-01	Coil, 23mH
L601	82-371-644-01	Coil, 22mH
VR101,102	82-387-619-01	Volume, 20kΩ-A (RECORD LEVEL)
VR103,104	82-387-613-01	Volume, 10kΩ-A (OUT PUT LEVEL)
J4	82-301-610-01	DIN socket (DIN-1)
S2,3	87-031-387-01	Lever switch (TAPE SELECTOR, EQ, BIAS)
S4	87-031-388-01	Lever switch (DOLBY-NR, MPX FILTER)
S12	87-031-389-01	Lever switch (IN PUT SELECTOR)
S17	82-387-620-01	Slide switch (DIN SWITCH)
SFR105,106	87-021-446-01	Semi-fixed resistor, 100kΩ-B
SFR201,202	87-021-445-01	Semi-fixed resistor, 10kΩ-B
SFR601	87-021-432-01	Semi-fixed resistor, 50kΩ-B
SFR701,702	87-021-512-01	Semi-fixed resistor, 2kΩ-B
SFR703,704	87-021-441-01	Semi-fixed resistor, 470kΩ-B
SFR705,706	87-021-366-01	Semi-fixed resistor, 10kΩ-B
PIN-K,L	87-032-776-01	Pin, 6P
		<Resistor>
R254	87-025-099-01	82Ω 1/4W Fuse resistor
		<Capacitors>
C707,708	87-015-260-01	0.22μF 35V Tantalun
C614	87-015-261-01	0.33μF 35V Tantalun
◀FILTER CIRCUIT BOARD SECTION▶		
PCB-C	82-387-695-01	Filter circuit board
Q601,602,603 604,605	89-309-456-01	Transistor, 2SC945L (P)
D701,702,703 704,705,706 707,708,713	87-026-066-01	Diode, M8513A (O)
D709,710,711 712	87-027-097-01	Diode, 1S1555
SFR602	87-021-432-01	Semi-fixed resistor, 50kΩ-B
◀SWITCH CIRCUIT BOARD SECTION▶		
PCB-D	82-387-693-01	Switch circuit board
Q137,138	89-309-456-51	Transistor, 2SC945L (R,Q)
Q501	89-309-456-01	Transistor, 2SC945L (P)
S19	82-387-635-01	Push switch (LIMITER)
S20,21	82-387-636-01	Push switch (PEAK, HOLD)
PIN-J	87-032-777-01	Pin, 7P
◀POWER/OSC CIRCUIT BOARD SECTION▶		
PCB-E	82-387-630-21	Power/OSC circuit board
Q801,802,804 805,902	89-309-456-01	Transistor, 2SC945L (P)
Q803,806	82-371-625-01	FET, 2SK30D
Q901	89-402-344-01	Transistor, 2SD234 (Y)
Q903	89-107-335-61	Transistor, 2SA733 (K, P)
D801,804	87-027-171-01	Zener diode, RD2.7 (E)
D802,803,805 806	87-026-066-01	Diode, M8513A (O)

Symbol No.	Part No.	Description
M1,PCB-Q	82-387-612-31	Motor, DC-EG (FG) (CASSETTE MOTOR)
PL4	82-380-659-01	Pilot lamp (TAPE RUN)
LM1,2	82-387-603-21	Level meter (PEAK/VU)
PH	87-387-616-31	Search head
J3	87-032-748-01	Jack 6.3 ϕ (PHONES)
S7,13	82-380-621-01	Sub-miniature switch (MAIN MOTOR, CASSETTE CARRIER MOTOR)
S8,14	87-031-261-01	Micro switch (AUTO STOP, REW)
S9	82-380-658-11	Leaf switch (PAUSE)
S11	87-031-342-01	Push switch (POWER)
S15	87-040-080-11	Counter
S18	82-370-604-11	Leaf switch (CUE/REV, MUTING)
S22	82-380-681-01	Leaf switch (CUE/REV BIAS CUT)
S23	82-375-623-01	Slide switch (DIN OUTPUT LEVEL)
S25	87-031-364-01	Slide switch (VOLTAGE SELECTOR) (H, EE model only)
S25	87-031-343-01	Slide switch (VOLTAGE SELECTOR) (UK model only)
F1	87-035-079-01	Fuse, 200mA "T"
	87-098-009-01	Fuse label, 200mA "T"

Symbol No.	Part No.	Description
F2	87-035-123-01	Fuse, 80mA "T" (UK model only)
	87-098-005-01	Fuse label, 80mA "T" (UK model only)
F3,4	87-035-144-01	Fuse, 250mA "T"
	87-098-010-01	Fuse label, 250mA "T"
F5	87-035-075-01	Fuse, 500mA "T"
	87-098-013-01	Fuse label, 500mA "T"
F6,7	87-035-151-01	Fuse, 40mA "T"
	87-098-002-01	Fuse label, 40mA "T"
	82-387-686-01	Fuse holder, 7P
	82-387-637-01	Connector, 1P (YEL)
	82-387-674-01	Connector, 1P (GRN)
	82-387-675-01	Connector, 1P (BLU)
CON-F	82-387-672-11	Connector ass'y, 4P
CON-E	82-387-673-11	Connector ass'y, 4P
CON-B	82-387-677-11	Connector ass'y, 4P
CON-N	82-387-638-01	Connector ass'y, 5P
CON-I	82-387-682-11	Connector ass'y, 5P
CON-G	82-387-643-11	Connector ass'y, 5P
CON-H	82-387-644-11	Connector ass'y, 5P
CON-K	82-387-641-01	Connector ass'y, 6P
CON-A	82-387-647-11	Connector ass'y, 6P
CON-L,O	82-387-687-01	Connector ass'y, 6P, 9P
CON-J	82-387-671-01	Connector ass'y, 7P
CON-D	82-387-645-11	Connector ass'y, 8P
CON-C	82-387-646-11	Connector ass'y, 8P
CON-M	82-387-639-11	Connector ass'y, 10P

Change of Motor Fuse Rating

Please note F4 has been replaced with a 315 mA 'T' fuse. If subsequent replacement is necessary, please ensure that a B.E.A.B. approved fuse is used.

AIWACO.,LTD.

770930 D-2

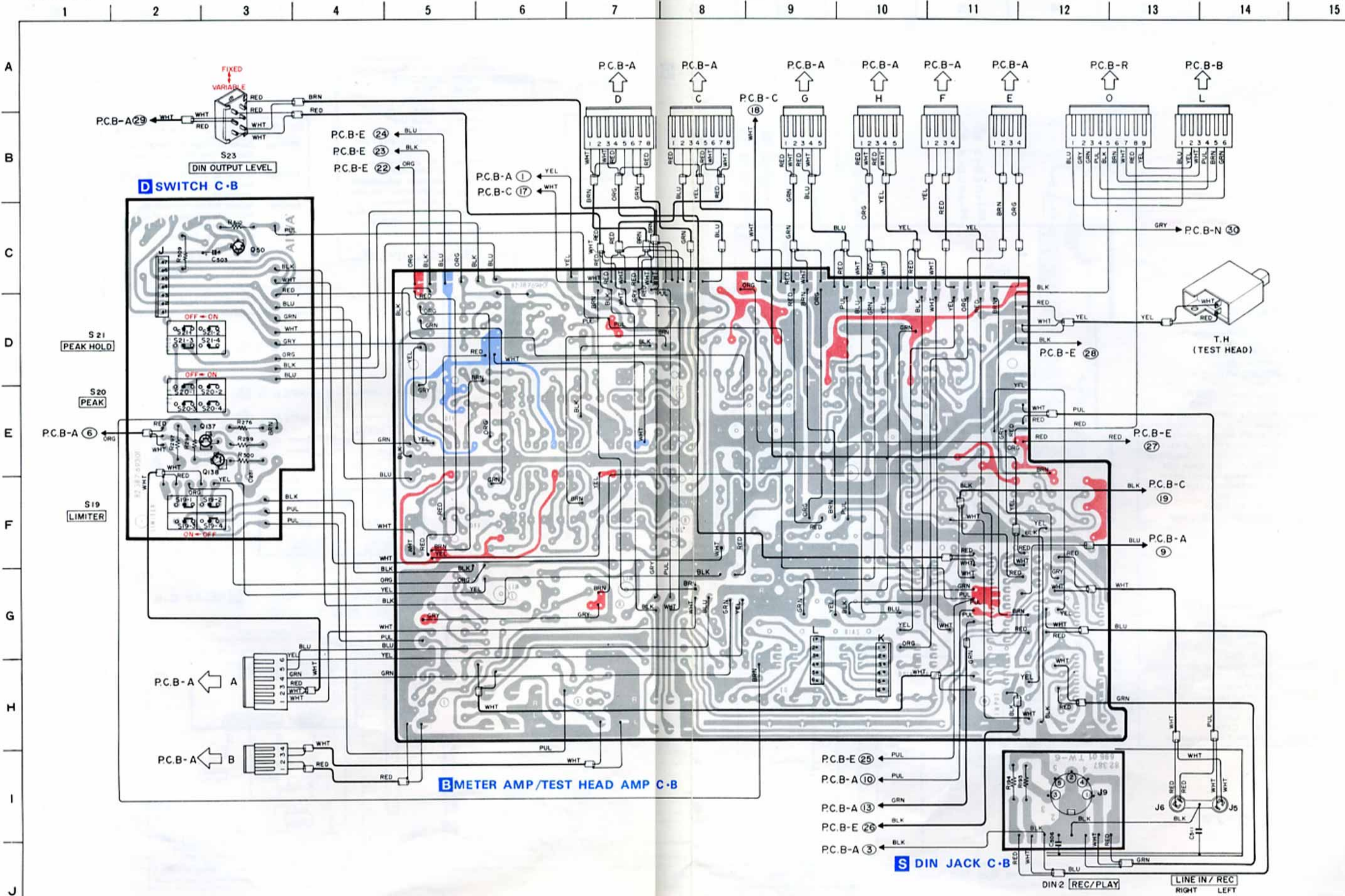

18. Peak Meter OVU Adjustment
 Settings: PEAK HOLD button: OFF
 PEAK switch: ON
 All other settings are the same as for the VU Meter Indication Adjustment under 5.
 Method: With the RECORD set to the recording mode, adjust the RECORD LEVEL potentiometers so that the LINE OUT output becomes 0.775V.
 Now adjust the peak meter indication to OVU.
 L-ch: SFR701, R-ch: SFR702
 Rating: OVU±0.3dB

5. VU Meter Indication Adjustment
 Settings: OUTPUT LEVEL control: MAX.
 DOLBY-NR switch: OFF
 Input signal: 400 Hz OVU + 10dB
 Method: With the model set to the recording mode, adjust the RECORD LEVEL potentiometers so that the LINE OUT output becomes 1.1V. Now adjust the VU meter indication to OVU ±3dB.
 L-ch: SFR201 R-ch: SFR202
 Rating: OVU +3 ±0.3dB (mark) with 1.1V LINE OUT output, OVU ±0.5dB with

28. Dolby-Nr Gain/Law Adjustment
 Settings: DOLBY-NR switch: OFF
 Input: TP5, 6 (Terminal 1)
 Output: TP7, 8 (Terminal 6)
 Input signal: 5 kHz
 Keep test point TP9 and 10 (Q309, 310 gates) earthed.
 Method: Before adjustment, turn low adjustment resistors SFR301 and 302 right round, in the direction indicated by the arrows. With the model set to the playback mode, apply a 5 kHz signal from terminal 1, and adjust the input signal for a value of 84 mV at terminal 6.
 Adjust the gain resistors so that the output is scaled down 10dB when the DOLBY-NR switch is set to ON.
 L-ch: SFR303, R-ch: SFR304
 Next, open gates Q309 and 310 and adjust low resistors so that the output is increased 2dB.
 L-ch: SFR301, R-ch: SFR302

19. Peak Meter Log.Amp. Adjustment
 Settings: OUTPUT LEVEL control: MAX.
 DOLBY-NR switch: OFF
 PEAK HOLD button: OFF
 PEAK switch: ON
 Input signal: 400 Hz OVU-30dB
 Method: With the model set to the recording mode, adjust so that the peak meter pointer indicates -30VU.
 L-ch: SFR703, R-ch: SFR704

17. Peak Meter Offset Adjustment
 Settings: OUTPUT LEVEL control: MIN.
 PEAK HOLD button: OFF
 Method: With the model set to the playback mode, adjust using the PEAK switch ON/OFF so that the peak meter pointer deflections do not vary.
 L-ch: SFR705, R-ch: SFR706

20. Limiter Sensitivity Adjustment
 Settings: OUTPUT LEVEL control: MAX.
 DOLBY-NR switch: OFF
 Input signal: 400 Hz OVU + 10dB
 Method: With the model set to the recording mode, adjust the RECORD LEVEL potentiometers so that the LINE OUT output becomes 0.775V.
 Next, set the limiter switch to ON, and then increase the input signal by 10dB. Now adjust the LINE OUT output to 1V.
 L-ch: SFR105, R-ch: SFR106
 Input signal: 400 Hz OVU + 10dB
 LINE OUT output: OVU + 3dB with limiter at ON.

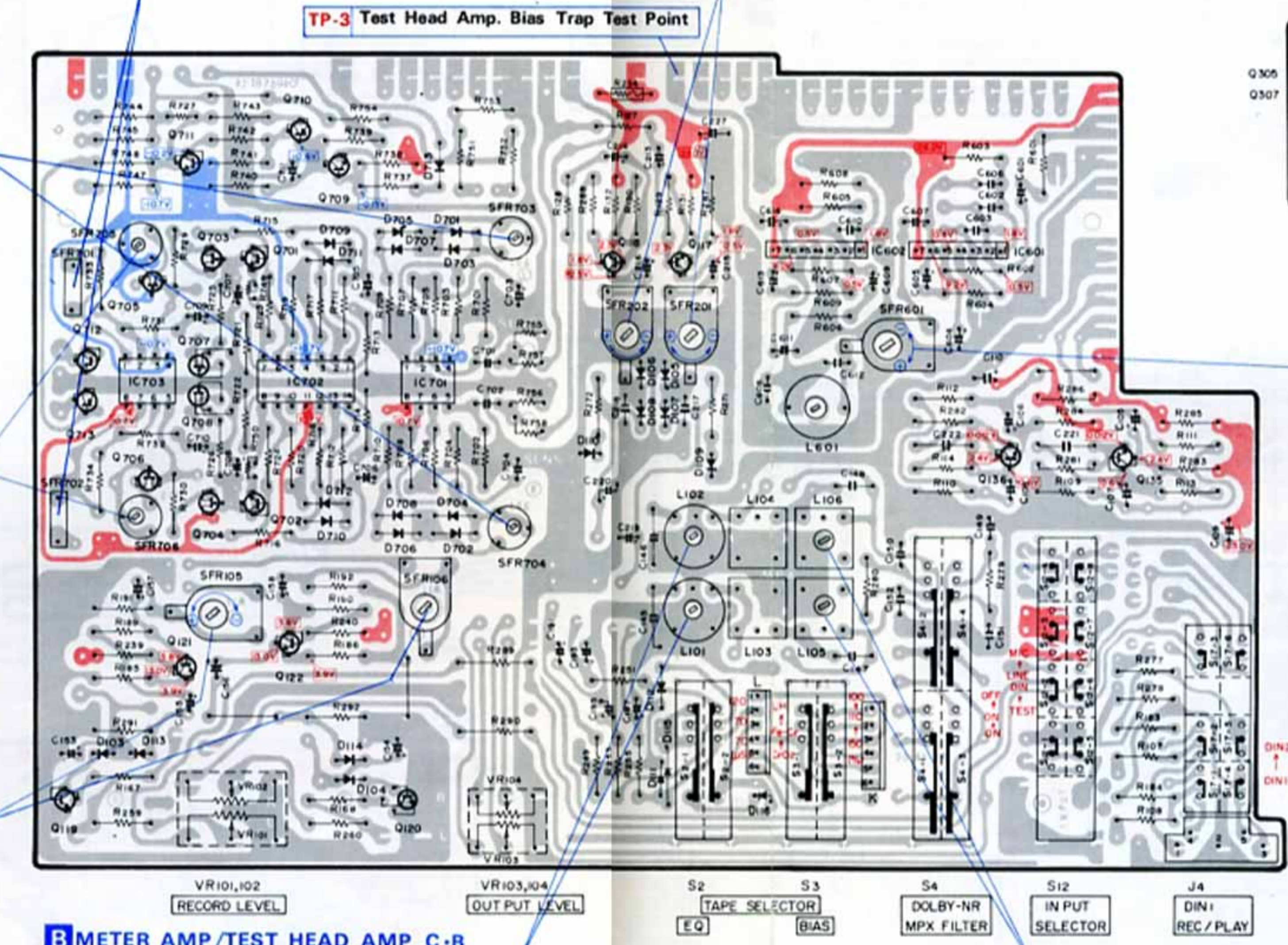

26. Dolby-Nr Bias Trap Adjustment
 Settings: INPUT SELECTOR switch: MIC
 RECORD LEVEL control: MAX.
 OUTPUT LEVEL control: MAX.
 DOLBY-NR switch: OFF
 Method: With the model in the recording mode, adjust so that the bias to the LINE OUT is reduced to the minimum.
 L-ch: L101, R-ch: L102

27. 19KHz MPX Filter Adjustment
 Settings: RECORD LEVEL control: MAX.
 OUTPUT LEVEL control: MAX.
 DOLBY-NR switch: ON (MPX FILTER: ON)
 Input signal: 19 kHz OVU
 Method: With the model set to the recording mode, adjust so that the LINE OUT output is reduced to the minimum.
 L-ch: L105, R-ch: L106
 Rating: A 30dB drop with the MPX FILTER ON/OFF.

24. 400Hz Meter Indication Adjustment
 Settings: INPUT SELECTOR switch: TEST
 TAPE SELECTOR switch: Fe-Cr
 Test tape: CS-30
 BIAS FINE control: Center
 Record 400 Hz/8 kHz OVU -20dB signals and then adjust after checking that the difference in the output level is 0:0.5dB.
 Method: With the model set to the recording mode, adjust SFR601 so that the left channel meter indication (400 Hz output level) is set to OVU.

23. Monitor Amp. Bias Trap Adjustment
 Settings: INPUT SELECTOR switch: TEST
 Test point: TP-3
 Set the model to the recording mode and then press the PAUSE operating key.
 Method: Adjust L601 to reduce the bias leakage to the test point to the minimum.

- NOTES:**
- B(+) pattern, B(-) pattern, other patterns.
 - Voltage value is reference value measured with a tester (50 k-ohms/V, DC) with silent recording. () is value during recording.
 - The adjustments can be divided in the following groups. They can be performed in any order but be sure to keep to the numerical order of adjustments within the groups:
 - Playback adjustments (1)~(4).
 - Recording adjustments (5)~(8).
 - Rec./pb. adjustments (9)~(16).
 - Peak meter adjustments (17)~(19).
 - Limiter adjustment (20).
 - Fat response tuning system adjustments (21)~(25).
 - Dolby-Nr adjustments (26)~(28).
 - Unless otherwise indicated, use the LINE IN/REC jack for the input and the LINE OUT/PLAY jack for the output.

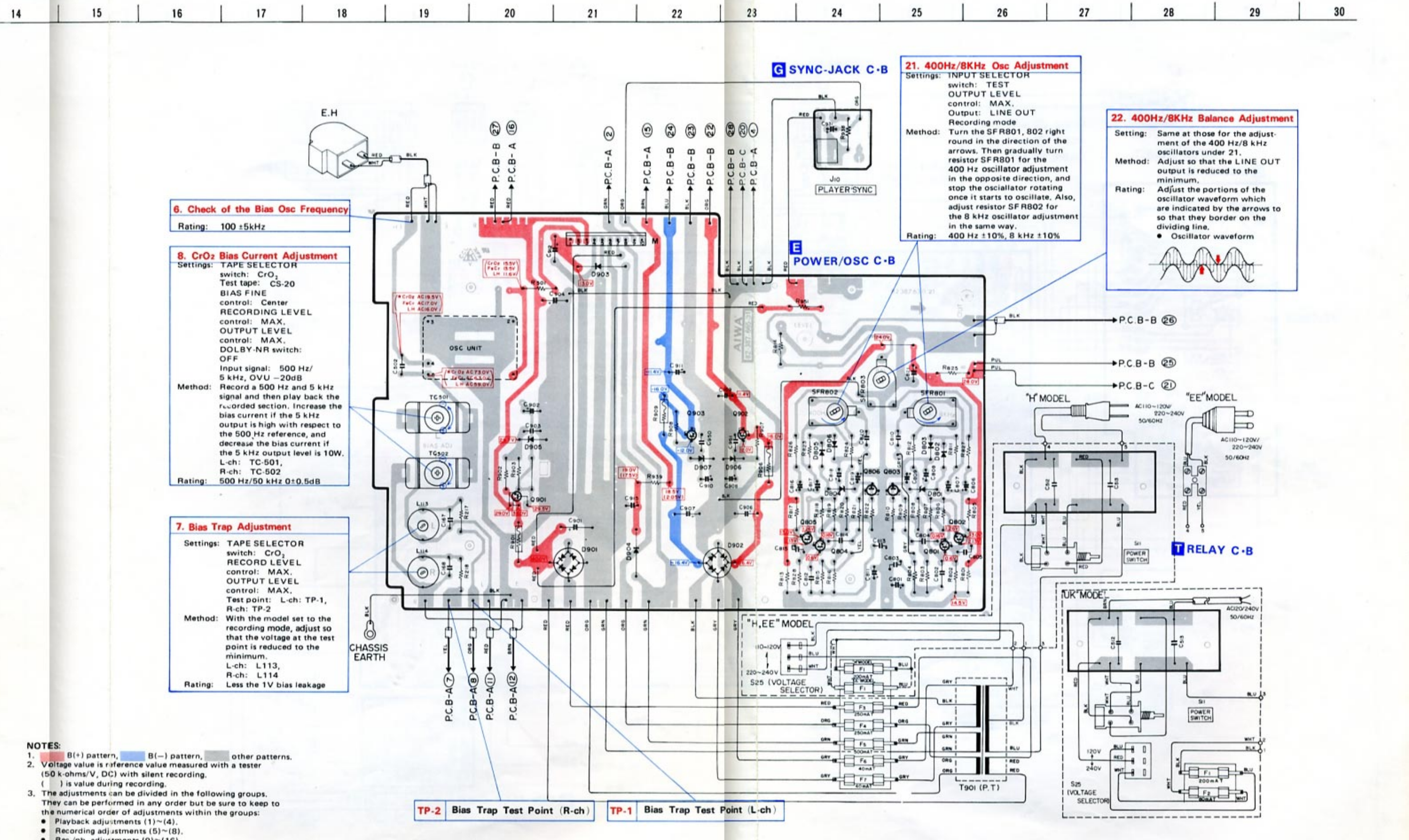
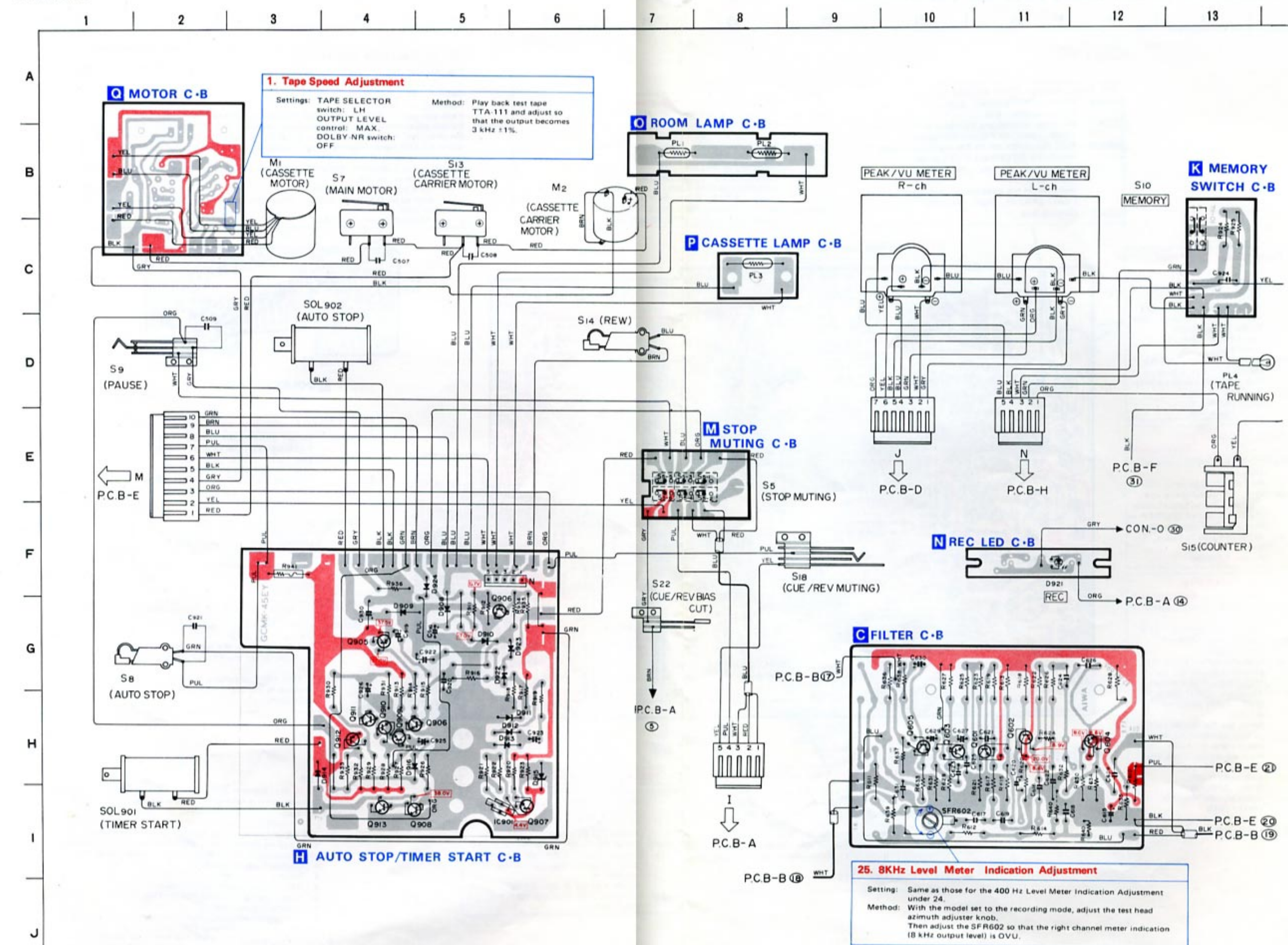

- NOTES:**
1. B(+) pattern, B(-) pattern, other patterns.
 2. Voltage value is reference value measured with a tester (50 k-ohms/V, DC) with silent recording. () is value during recording.
 3. The adjustments can be divided in the following groups. They can be performed in any order but be sure to keep to the numerical order of adjustments within the groups:
 - Playback adjustments (1)~(4).
 - Recording adjustments (5)~(8).
 - Rec./pb. adjustments (9)~(16).
 - Peak meter adjustments (17)~(19).
 - Limiter adjustment (20).
 - Flat response tuning system adjustments (21)~(25).
 - Dolby-Nr adjustments (26)~(28).
 4. Unless otherwise indicated, use the LINE IN/REC jack for the input and the LINE OUT/PLAY jack for the output.

TP-2 Bias Trap Test Point (R-ch) TP-1 Bias Trap Test Point (L-ch)

SCHEMATIC DIAGRAM

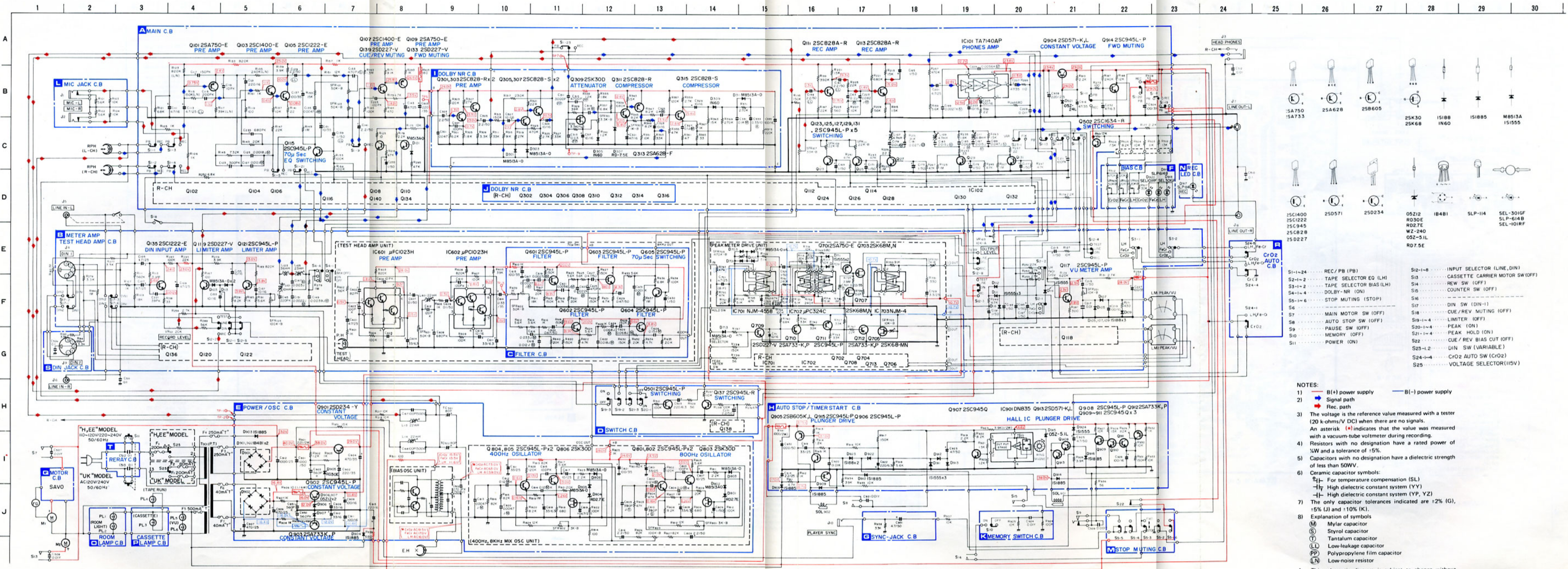

- | | |
|--|--|
| <ul style="list-style-type: none"> 1) B(+) power supply 2) Signal path 3) Rec. path | <ul style="list-style-type: none"> 4) The voltage is the reference value measured with a tester (20 k-ohms/V DC) when there are no signals. An asterisk (*) indicates that the value was measured with a vacuum-tube voltmeter during recording. 5) Resistors with no designation have a rated power of 1/4W and a tolerance of ±5%. 6) Capacitors with no designation have a dielectric strength of less than 50WV. 7) Ceramic capacitor symbols: <ul style="list-style-type: none"> □—□ For temperature compensation (SL) — — High dielectric constant system (YY) — — High dielectric constant system (YP, YZ) 8) The only capacitor tolerances indicated are ±2% (G), ±5% (J) and ±10% (K). |
|--|--|
-
- | | |
|---|--|
| <ul style="list-style-type: none"> 9) Explanation of symbols: <ul style="list-style-type: none"> (M) Mylar capacitor (S) Styrol capacitor (T) Tantalum capacitor (LL) Low-leakage capacitor (PP) Polypropylene film capacitor (LN) Low-noise resistor | <p>NOTES:</p> <ul style="list-style-type: none"> 1) REC / PB (PB) 2) TAPE SELECTOR EQ (LH) 3) TAPE SELECTOR BIAS (LH) 4) DOLBY-NR (ON) 5) STOP MUTING (STOP) 6) DIN SW (DIN-1) 7) CUE / REV MUTING (OFF) 8) AUTO STOP SW (OFF) 9) LIMITER (OFF) 10) PAUSE SW (OFF) 11) MEMORY (OFF) 12) PEAK (ON) 13) PEAK HOLD (ON) 14) CUE / REV BIAS CUT (OFF) 15) DIN SW (VARIABLE) 16) CrO2 AUTO SW (CrO2) 17) VOLTAGE SELECTOR (115V) |
|---|--|

This schematic diagram is subject to change without notice in the interests of improved performance.