

STEREO AMPLIFIER

KA-7050R

SERVICE MANUAL

KENWOOD

© 1992-10 PRINTED IN JAPAN
B51-4553-00 (S) 2606

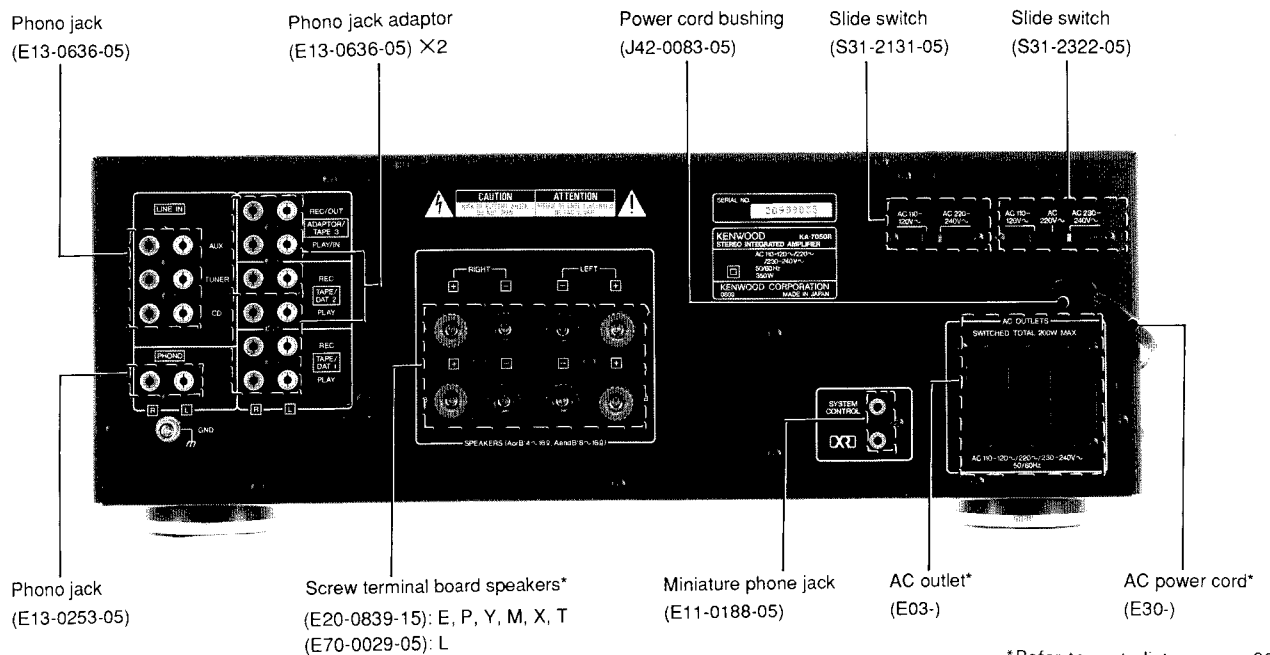
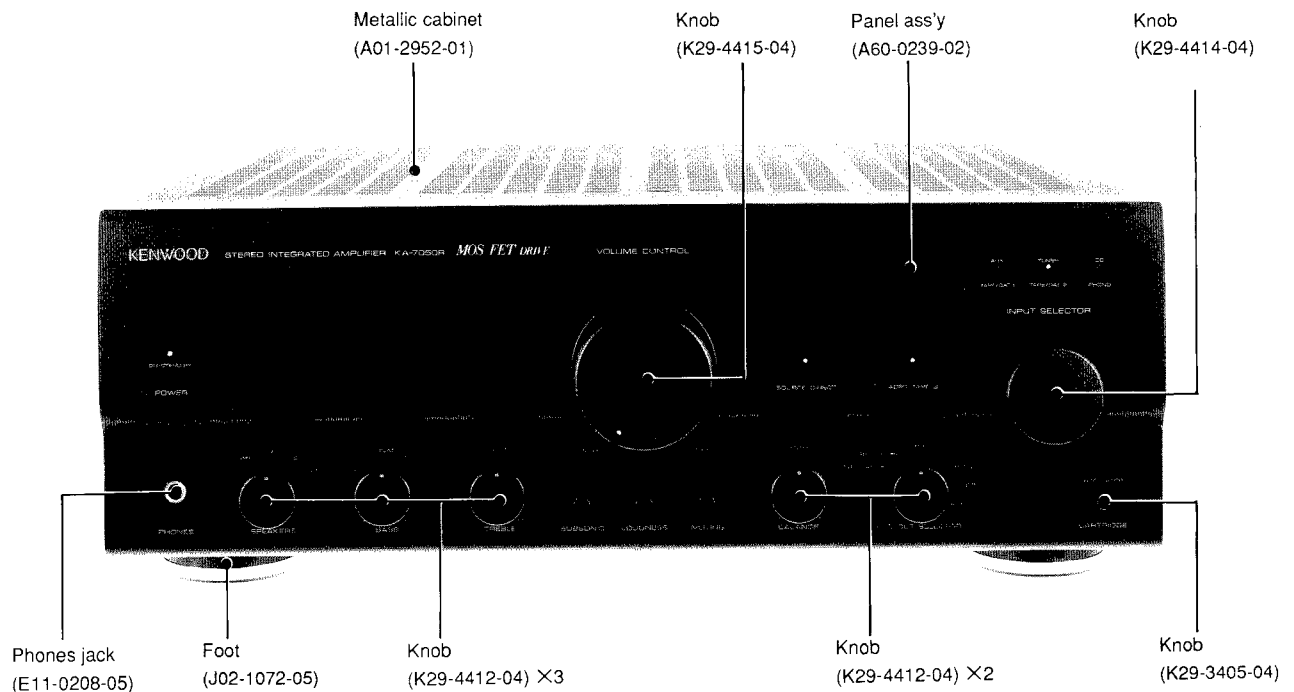

*Refer to parts list on page 29.

PRECAUTIONS FOR REPAIR

Handle the power MOS-FETs carefully. They are easily destroyed by static electricity.

KA-7050R

CONTENTS

NOTES	2	PC BOARD	13
CIRCUIT DESCRIPTION	3	SCHEMATIC DIAGRAM	19
ADJUSTMENT	9	EXPLODED VIEW	29
REGLAGE	10	PARTS LIST	29
ABGLEICH	11	REMOTE CONTROL OPERATION	39
WIRING DIAGRAM	12	SPECIFICATIONS	BACK COVER

INSTRUCTION MANUAL

B60-0882-00 ENGLISH	E, P, Y, M, X, T, L
B60-0883-00 FRENCH	E, P, L
B60-0884-00 SPANISH	E, M, L
B60-0885-00 CHINESE	M

NOTES

- Handle the power MOS-FETs carefully. They are easily destroyed by static electricity.
- When soldering, use a high-insulation soldering iron.
- When soldering, solder the gate (G) first.
- When replacing the power MOS-FET, there are differences according to the ranks, so please replace Pch (or Nch) as a pair of identical rank.
- The parts stock for parts of the same rank as Pch (or Nch) come in packs of pairs.
When ordering a quantity of 1, one pack (containing 2) will be delivered in one bag.
Please order as (2SK1530-LBP2, 2SJ201-LBP2).
LBP2 means one pack containing one pair.
There is no need to adjust the ranks of Pch and Nch, and there is no need to adjust the ranks of the left channel and right channel either.
- Since the KA-7050R is a FET amp, even with no signal, nearly as much heat is generated as for maximum output.
When piling sets on top of each other, put this amp at the top. Placing any other unit on top of this amp interferes with the heat release and can cause harm, so do not do this.

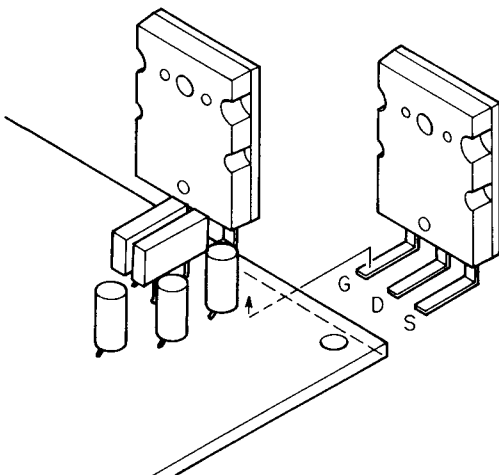

CIRCUIT DESCRIPTION

Characteristics of the power MOS-FET

1. Types of MOS-FET

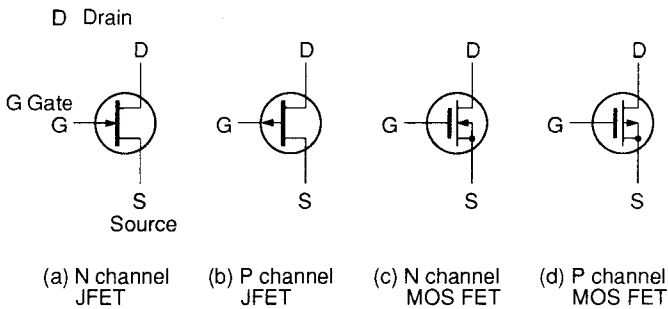
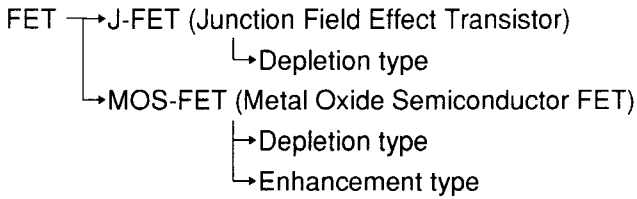

2. Characteristics of J-FET

The mutual conductance/ g_m corresponds to a general transistor h_{fe} .

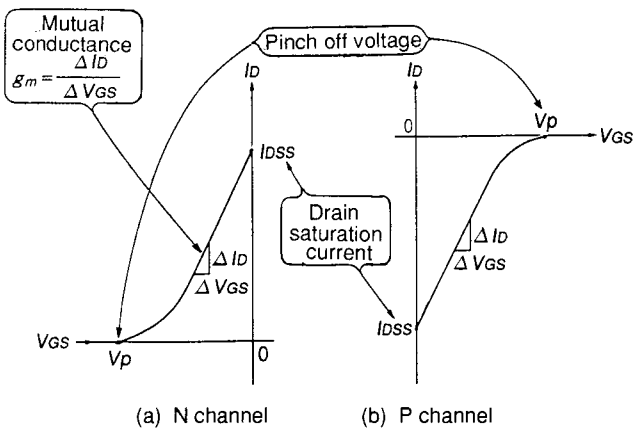

3. Characteristics of MOS-FET (Depletion type)

The point that differs from the J-FET is that even if the gate bias (V_{GS}) is 0V, the current continues to flow. At this time, I_{DSS} is not the drain saturation current.

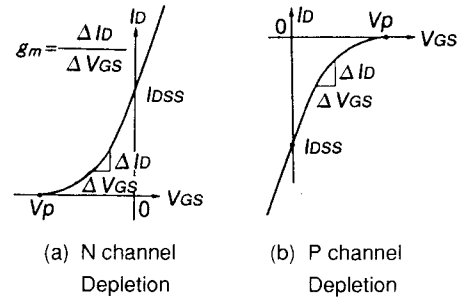

4. Characteristics of MOS-FET (Enhancement type)

The power MOS-FET in this unite uses this type. As the gate bias voltage operates in the same way as a normal power transistor, it has a mechanism that it easy to use.

However, as the gate is voltage-controlled, there is no electric current flow.

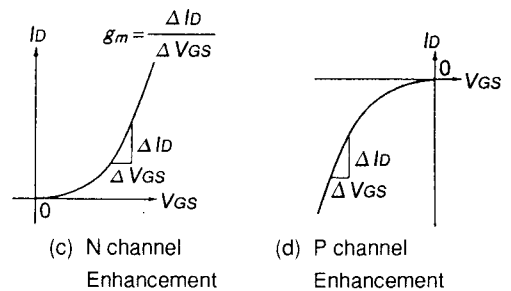

KA-7050R

CIRCUIT DESCRIPTION

MICROPROCESSOR (μ PD75104G-778)

1. TEST MODE

1.1 Test Mode Using Mainframe Keys

(1) Setting

Plug in while pressing the SOURCE DIRECT key.

(2) Contents

- Switch the power on so that all LED indicators go on. Operate all tact keys and the rotary encoder to cancel all the LED indicators that go on. In the all-light mode, all the INPUT SELECTOR LED indicators do not go on at the same time. The next SELECTOR LED indicator goes on approximately 100 ms after one SELECTOR LED indicator goes on in the same order as during input selector selection using the rotary encoder, because the output current exceeds the absolute maximum rating when all the INPUT SELECTOR LED indicators go on, since each LED indicator is directly driven by a microcomputer.
- When the LOUDNESS key is pressed while the test mode is set with a mainframe key The electromotive volume decreases. When the MUTING key is pressed, the volume increases. The volume stops when the SOURCE DIRECT key is pressed.

(3) Cancellation

- Plug off. If there a backup function is to be used, plug off and reset the backup check data when a test mode flag is set during backup operation.

2. INITIALIZING

Insert the AC plug into a wall outlet while pressing the POWER key.

CIRCUIT DESCRIPTION

Diagram of microcomputers peripheral equipment

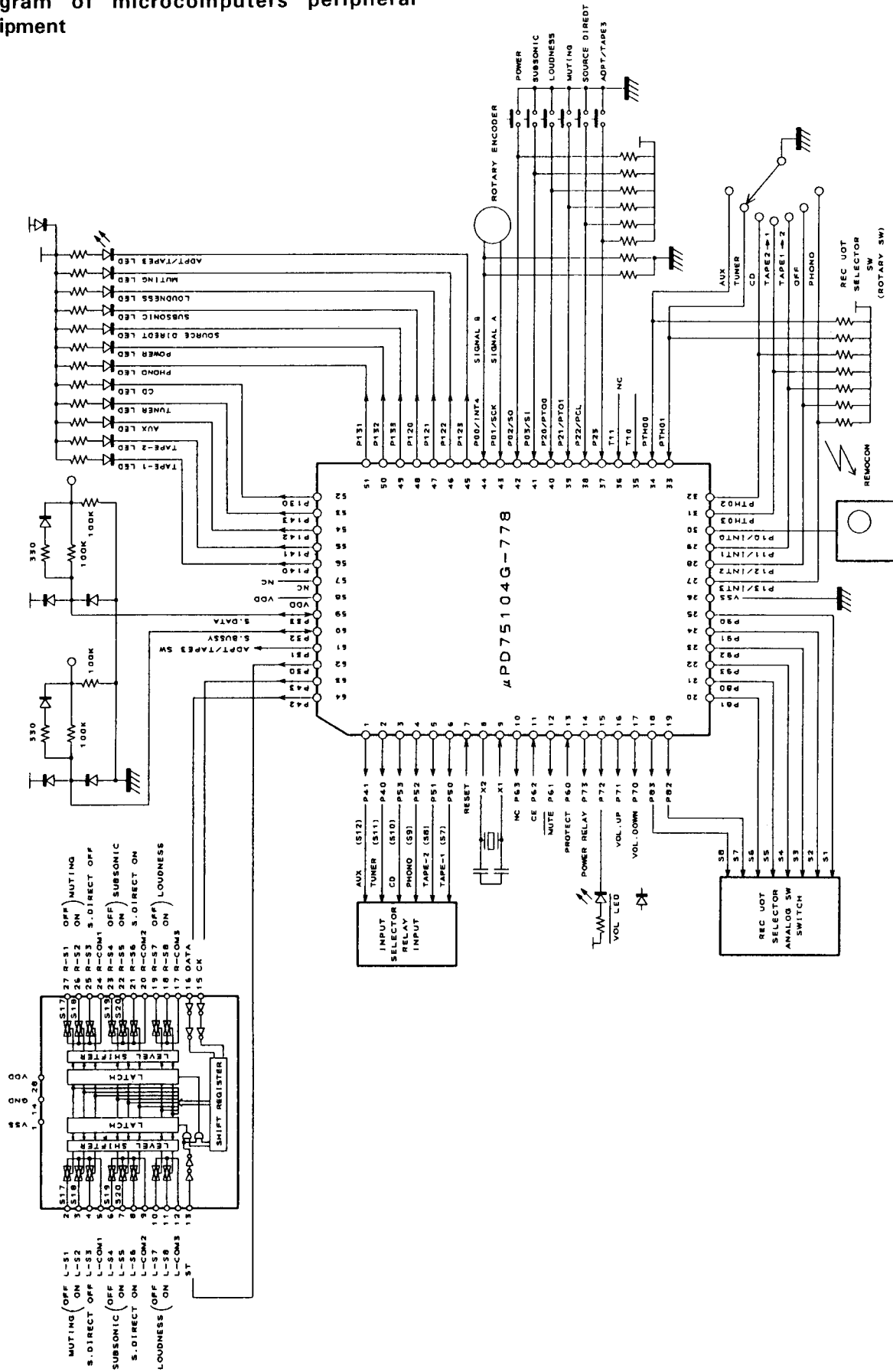

KA-7050R

CIRCUIT DESCRIPTION

PIN FUNCTIONS

Pin No.	Pin name	I/O	Name	Description
1	P41	O	SRAUX	AUX SELECTOR RELAY control pin (high when active). Outputs a low signal in the backup mode.
2	P40	O	SRTUNER	TUNER SELECTOR RELAY control pin (high when active). Outputs a low signal in the backup mode.
3	P53	O	SRCD	CD SELECTOR RELAY control pin (high when active). Outputs a low signal in the backup mode.
4	P52	O	SRPHONO	PHONO SELECTOR RELAY control pin (high when active). Outputs a low signal in the backup mode.
5	P51	O	SRTAPE2	TAPE2 SELECTOR RELAY control pin (high when active). Outputs a low signal in the backup mode.
6	P50	O	SRTAPE1	TAPE1 SELECTOR RELAY control pin (high when active). Outputs a low signal in the backup mode.
7	RESET	I		Microcomputer reset input pin.
8	X2	O		Ceramic connection pin for microcomputer system clock oscillation (4.19 MHz).
9	X1	I		
10	P63	O	RMUTE	Unused. Enters the input mode during backup.
11	P62	I	CE	Backup state detection pin (low when active). Enters the input mode during backup.
12	P61	O	MUTE	Mute signal output pin (high when active). Enters the input mode during backup.
13	P60	I	PROTECT	Protect state detection pin (high when active). The POWER LED indicator blinks when a high signal is input to this pin during the power-on sequence. Enters the input mode during backup.
14	P73	O	POWER RELAY	POWER RELAY control pin. POWER ON: High POWER OFF: Low Enters the input mode during backup.
15	P72	O	VOL. LED	Volume index LED control pin. Goes on: Low Goes off: High Enters the input mode during backup.
16	P71	O	VOL. UP	Electromotive volume control Up signal output pin. Volume control Up: High Except volume control Up: Low Enters the input mode during backup.
17	P70	O	VOL. DOWN	Electromotive volume control Down signal output pin. Volume control Down: High Except volume control Down: Low
18~25	P83~P90	O	RSW01~RSW08	Control signal output pin of REC OUT SELECTOR analog switch (high when active). Outputs a signal according to the REC Out selector state as shown on the attached sheet, Outputs a low signal in the backup mode.
26	Vss		GND	Microcomputer GND pin.
27	P13/INT3	I	RSWI (PHONO)	REC out selector state setting input pin (PHONO). (Low when active.)
28	P12/INT2	I	RSWI (OFF)	REC out selector state setting input pin (OFF). (Low when active.)
29	P11/INT1	I	RSWI (TAPE1→2)	REC out selector state setting input pin (TAPE1→TAPE2). (Low when active.)

CIRCUIT DESCRIPTION

Pin No.	Pin name	I/O	Name	Description
30	PIO/INITO	I	REMOCON IN	Remote control signal input pin.
31	PTH03	I	RSWI (TAPE2→1)	REC out selector state setting input pin (TAPE2 → TAPE1). (Low when active.)
32	PTH02	I	RSWI (CD)	REC out selector state setting input pin (CD). (Low when active.)
33	PTH01	I	RSWI (TUNER)	REC out selector state setting input pin (TUNER). (Low when active.)
34	PTH00	I	RSWI (AUX)	REC out selector state setting input pin (AUX). (Low when active.)
35	TIO	I	NC	Unused.
36	TI1	I	NC	Unused.
37	P23	I	KEYIN (ADPT/TAPE3)	ADPT/TAPE3 key input pin (low when active). Enters the input mode during backup.
38	P22/PCL	I	KEYIN (SOURCE DIRECT)	SOURCE DIRECT key input pin (low when active). Enters the input mode during backup.
39	P21/PTO1	I	KEYIN (MUTING)	MUTING key input pin (low when active). Enters the input mode during backup.
40	P20/PTO0	I	KEYIN (LOUDNESS)	LOUDNESS key input pin (low when active). Enters the input mode during backup.
41	PO3/SI	I	KEYIN (SUBSONIC)	SUBSONIC key input pin (low when active).
42	PO2/SO	I	KEYIN (POWER)	POWER key input pin (low when active). Enters the input mode during backup.
43	PO1/SCK	I	REI A	ROTARY ENCODER A signal input pin. Enters the input mode during backup.
44	PO0/INT4	I	REI B	ROTARY ENCODER B signal input pin.
45	PI23	O	ADPT/TAPE23 LED	ADPT/TAPE3 LED control pin (low when active). No pull-up resistor is incorporated by a mask option. Enters the input mode during backup.
46	PI22	O	MUTING LED	MUTING LED control pin (low when active). No pull-up resistor is incorporated by a mask option. Enters the input mode during backup.
47	PI21	O	LOUDNESS LED	LOUDNESS LED control pin (low when active). No pull-up resistor is incorporated by a mask option. Enters the input mode during backup.
48	P120	O	SUBSONIC LED	SUBSONIC LED control pin (low when active). No pull-up resistor is incorporated by a mask option. Enters the input mode during backup.
49	P133	O	SOURCE DIRECT LED	SOURCE DIRECT LED control pin (low when active). No pull-up resistor is incorporated by a mask option. Enters the input mode during backup.
50	PI32	O	POWER LED	POWER LED control pin (low when active). No pull-up resistor is incorporated by a mask option. Enters the input mode during backup.
51	PI31	O	PHONO LED	PHONO LED control pin (low when active). No pull-up resistor is incorporated by a mask option. Enters the input mode during backup.
52	PI30	O	CD LED	CD LED control pin (low when active). No pull-up resistor is incorporated by a mask option. Enters the input mode during backup.

KA-7050R

CIRCUIT DESCRIPTION

Pin No.	Pin name	I/O	Name	Description
53	PI43	O	TUNER LED	TUNER LED control pin (low when active). No pull-up resistor is incorporated by a mask option. Enters the input mode during backup.
54	PI42	O	AUX LED	AUX LED control pin (low when active). No pull-up resistor is incorporated by a mask option. Enters the input mode during backup.
55	PI41	O	TAPE2 LED	TAPE1 LED control pin (low when active). No pull-up resistor is incorporated by a mask option. Enters the input mode during backup.
56	PI40	O	TAPE1 LED	TAPE1 LED control pin (low when active). No pull-up resistor is incorporated by a mask option. Enters the input mode during backup.
57	NC			
58	Vdd			Microcomputer power supply pin.
59	P33	I/O	SDATA	Serial communication SDATA signal input/output pin. Enters the input mode during backup.
60	P32	I/O	SBUSY	Serial communication SBUSY signal input/output pin. Enters the input mode during backup.
61	P31	O	ADPT/TAPE3	ADPT/TAPE3 analog switch control signal output pin. ADPT/TAPE3 ON: High ADPT/TAPE3 OFF: low Outputs a low signal in the backup mode.
62	P30	O	ST1	FUNCTION IC TC9163N ST signal output pin for MUTING, SUBSONIC, SOURCE DIRECT, and LOUDNESS. Usually set low. Outputs a low signal in the backup mode.
63	P43	O	CK1	FUNKTION IC TC9163N CK signal output pin for MUTING, SUBSONIC, SOURCE DIRECT, and LOUDNESS. Usually set low. Outputs a low signal in the backup mode.
63	P43	O	DATA1	FUNCTION IC TC9163N DATA signal output pin for MUTING, SUBSONIC, SOURCE DIRECT, and LOUDNESS. Usually set low. Outputs a low signal in the backup mode.

ADJUSTMENT

No.	Item	Input setting	Output setting	Amp setting	Adjustment location	Adjustment method	Diag.
Unless otherwise specified, set the switches as follows: POWER: ON SPEAKER: B REC OUT: OFF SELECTOR: PHONO							
1	Offset voltage	—	Connect DC voltmeter to the Speaker B terminals.	VOLUME: 0		0V	
2	No-signal current	—	Connect DC voltmeter to CN2 (Adjustment explained below)	VOLUME: 0	VR1, VR3 (L) VR2, VR4 (R)	28 mV	(a)

No-signal current adjustment procedure

- ① Turn VR1-4 all the way to the left (counter-clockwise).
(No signal current 0)
- ② Lch adjustment
 - a) Connect the DC voltmeter to Pins 5 and 6 of CN2. (Figure a)
 - b) Turn VR1 to the right until the DC voltmeter reads 28 mV.
 - c) If the voltmeter reading does not reach 28 mV even with VR1 turned all the way to the right, turn VR3 to the right until the DC voltmeter reads 28 mV.
- ③ To adjust the Rch, connect the DC voltmeter to Pins 3 and 4 of CN2, then the same as for the Lch (Figure a), adjust first with VR2, then if necessary with VR4.

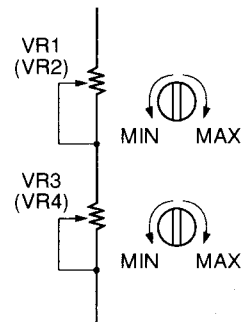

(a) L ch Adjustment

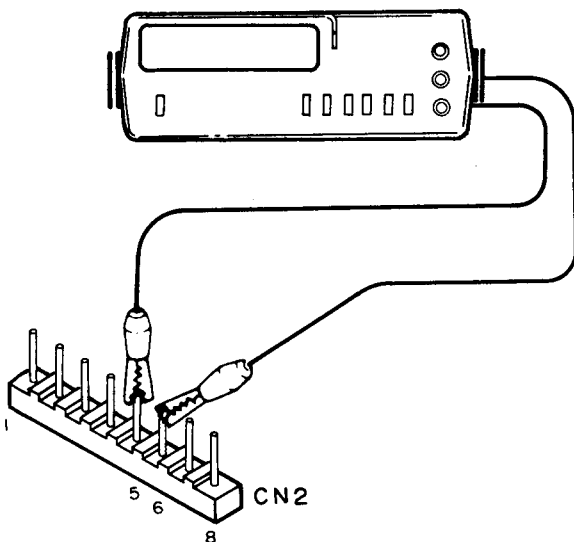

(a) R ch Adjustment

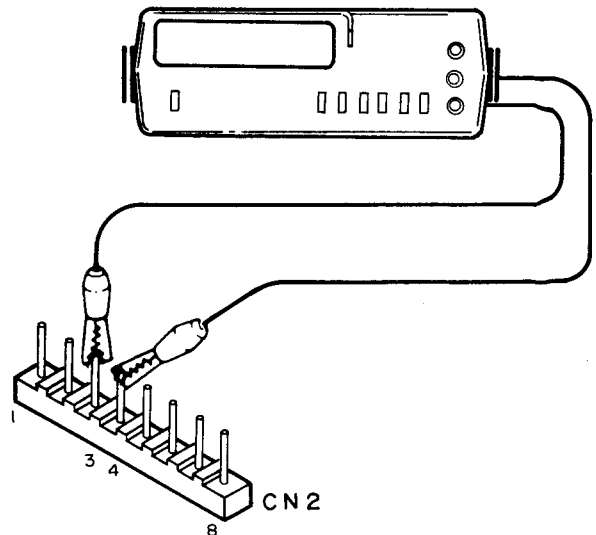

REGLAGE

Ordre.	Sujet	Réglage d'entrée	Réglage de sortie	Réglage de l'amplifier	Points d'ajustement	Méthode d'ajustement	Figure
Saut indication contraire, régler les commutateurs respectifs comme suit : ALIMENTATION : ON HAUT-PARLEUR : B SORTIE D'ENREGISTREMENT : OFF SELECTEUR : PHONO							
1	Tension de décalage	—	Brancher le voltmètre CC sur les bornes du haut-parleur B.	VOLUME: 0		0V	
2	Courant sans signal	—	Brancher le voltmètre CC sur CN 2 (réglage expliqué ci-dessous)	VOLUME: 0	VR1, VR3 (L) VR2, VR4 (R)	28 mV	(a)

Réglage sur courant sans signal

- ① Tourner VR 1-4 entièrement vers la gauche (dans le sens contraire des aiguilles d'une montre)
(Courant sans signal 0)
- ② Réglage du canal gauche
 - a) Brancher le voltmètre CC sur les broches 5 et 6 de CN 2. (Figure a)
 - b) Tourner VR 1 vers la droite jusqu'à ce que le voltmètre indique 28 mV.
 - c) Si l'indication du voltmètre n'atteint pas 28 mV, même quand VR1 est tourné entièrement vers la droite, tourner VR3 vers la droite de sorte qu'il indique 28 mV.
- ③ Pour régler le canal droit, brancher le voltmètre sur les broches 3 et 4 de CN 2, de même que pour le canal gauche (figure a), régler d'abord avec VR 2, puis si nécessaire avec VR 4.

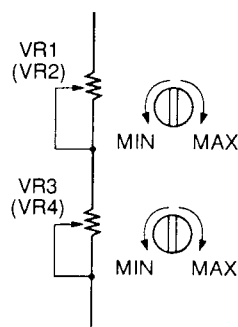

(a) Réglage du canal gauche

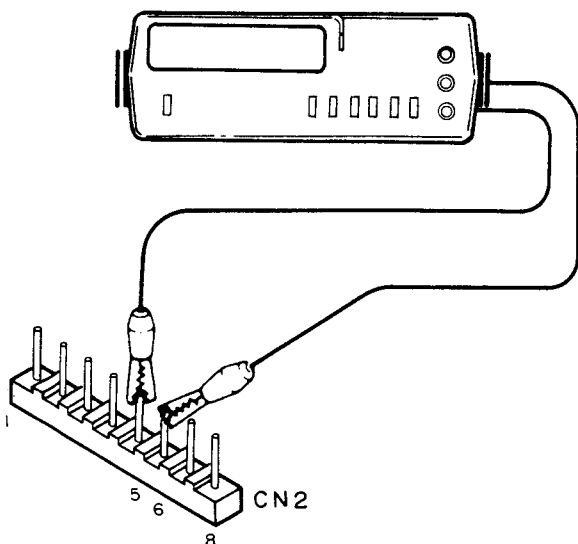

(a) Réglage du canal droit

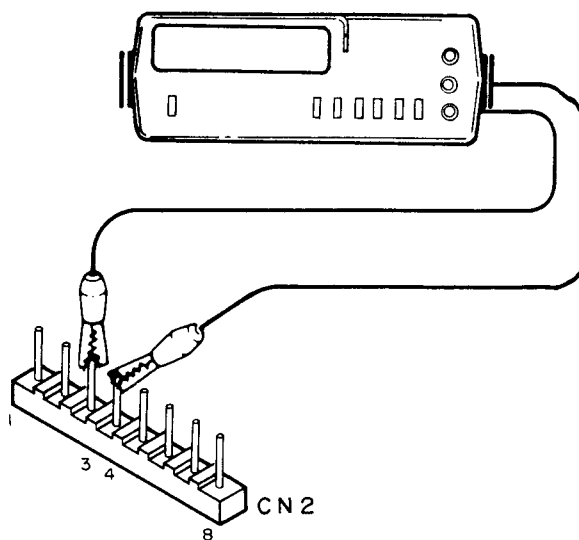

ABGLEICH

WIRING DIAGRAM

Rel-hent-olge	Gegenstand	Eingangs-Einstellung	Ausgangs-Einstellung	Amp-Einstellung	Abgleichpunkte	Abgleichmethode	Ab-bildung
Wenn nicht anders angegeben, die einzelnen Schalter wie folgt einstellen : NETZSCHALTER : ON LAUTSPRECHER : B AUFNAHME-AUSGANG : OFF REGLER : PHONO							
1	Verlagerungsspannung	—	Den Gleichstrom-Voltmeter an den Lautsprecheranschluß Banschließen.	VOLUME: 0		0V	
2	Kein-Signal-Spannung	—	Den Gleichstrom-Voltmeter an CN 2 anschließen (unten erklärte Einstellung).	VOLUME: 0	VR1, VR3 (L) VR2, VR4 (R)	28 mV	(a)

Einstellung der Kein-Signal-Spannung

- ① Drehen Sie VR 1-4 ganz nach links (im Gegenzeigersinn)
(Kein-Signal-Spannung 0)
- ② Einstellung des linken Kanals
 - a) Schließen Sie den Gleichstrom-Voltmeter an die Pole 5 und 6 von CN 2 an (Abbildung a).
 - b) Drehen Sie VR 1 nach rechts, bis der Gleichstrom-Voltmeter 28 mV anzeigt.
 - c) Falls die Messung 28 mV nicht erreicht, selbst nachdem VR 1 ganz nach rechts gedreht wurde, drehen Sie VR 3 nach rechts, bis der Gleichstrom-Voltmeter 28 mV anzeigt.
- ③ Schließen Sie den Gleichstrom-Voltmeter zur Einstellung des rechten Kanals an die Pole 3 und 4 von CN 2 an, und stellen Sie den Kanal auf die gleiche Weise wie den linken Kanal ein (Abbildung a), d.h. zuerst VR 2 und dann, falls notwendig, VR 4 einstellen.

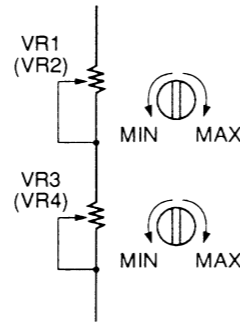

(a) Einstellung des linken Kanals

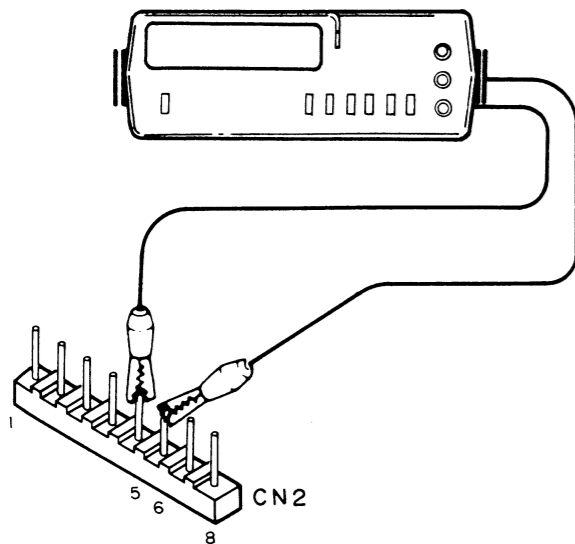

(a) Einstellung des rechten Kanals

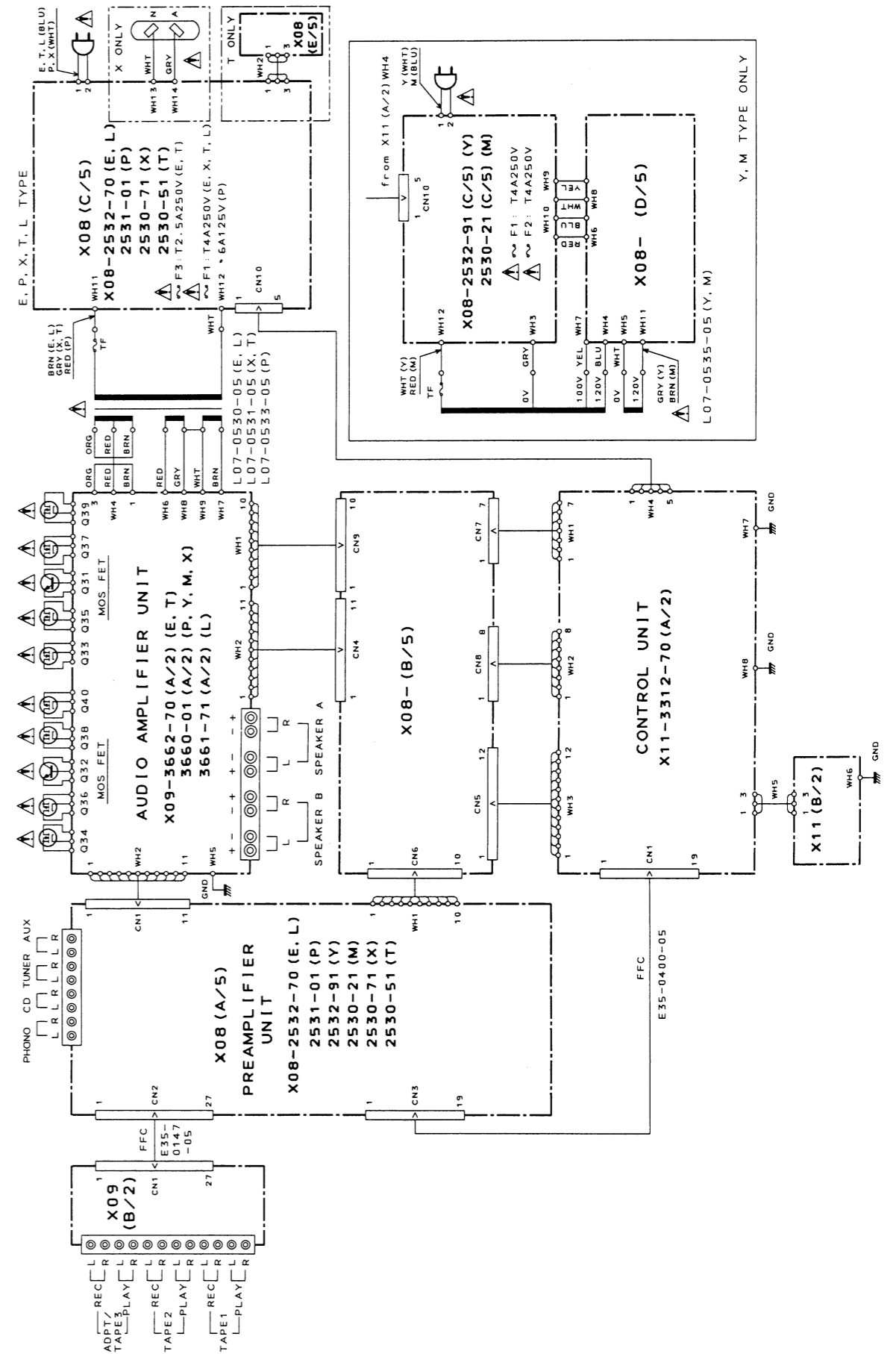
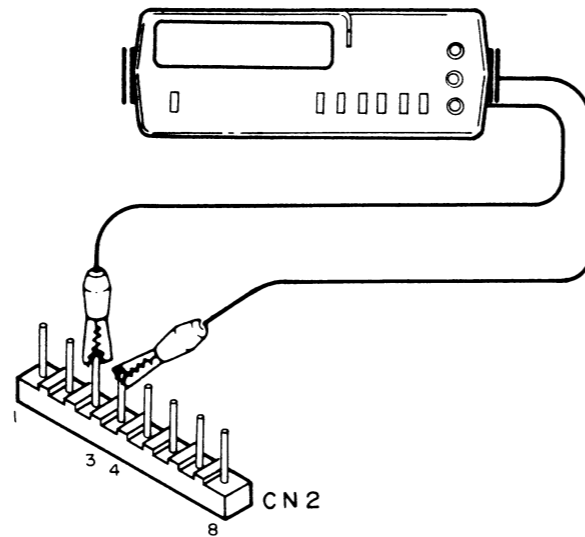

PC BOARD (Component side view)

PREAMPLIFIER UNIT (X08-253X-XX)

T TYPE ONLY

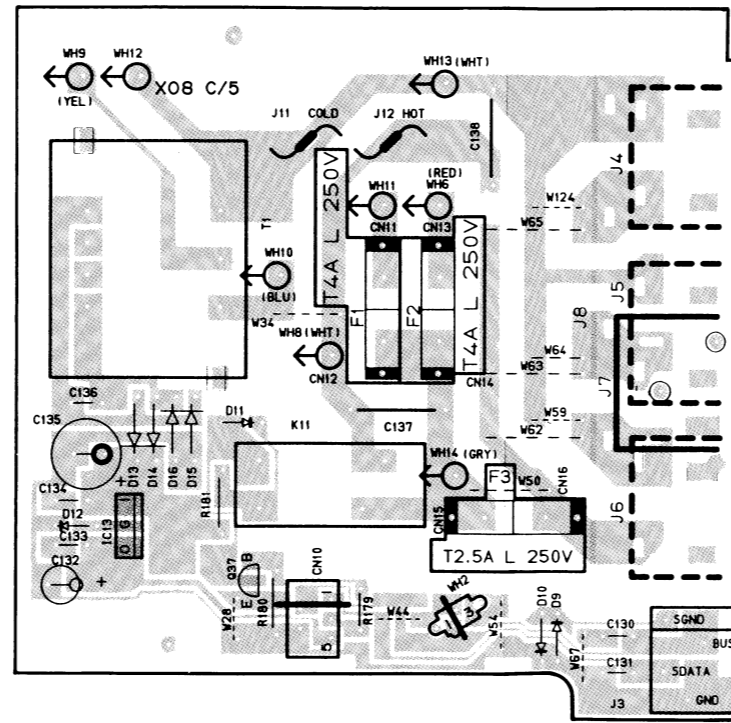
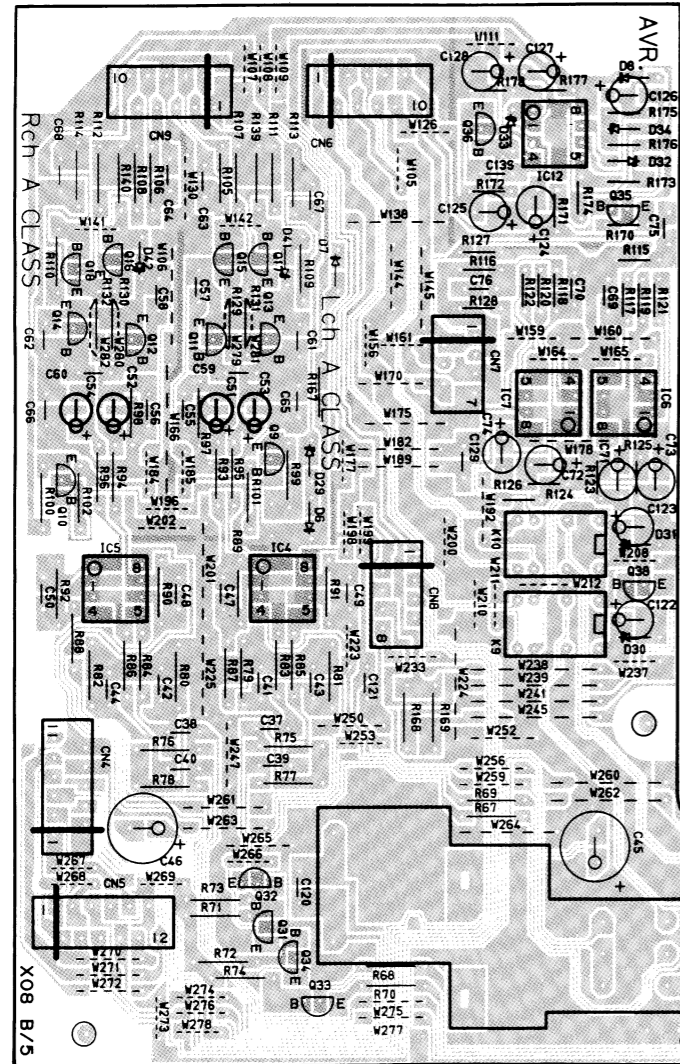
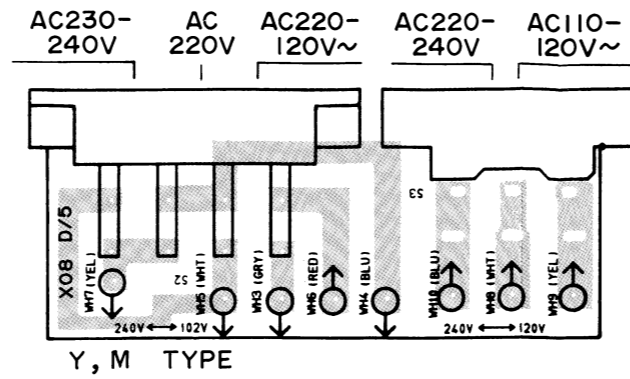
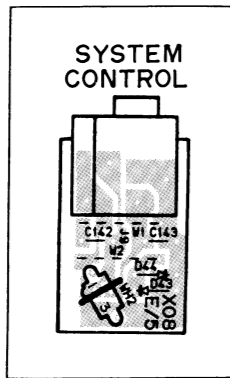

AC OUTLETS
SWITCHED TOTAL 200W MAX
AC110-120/220~/230-240V~
50/60Hz

VOLUME CONTROL

FRONT

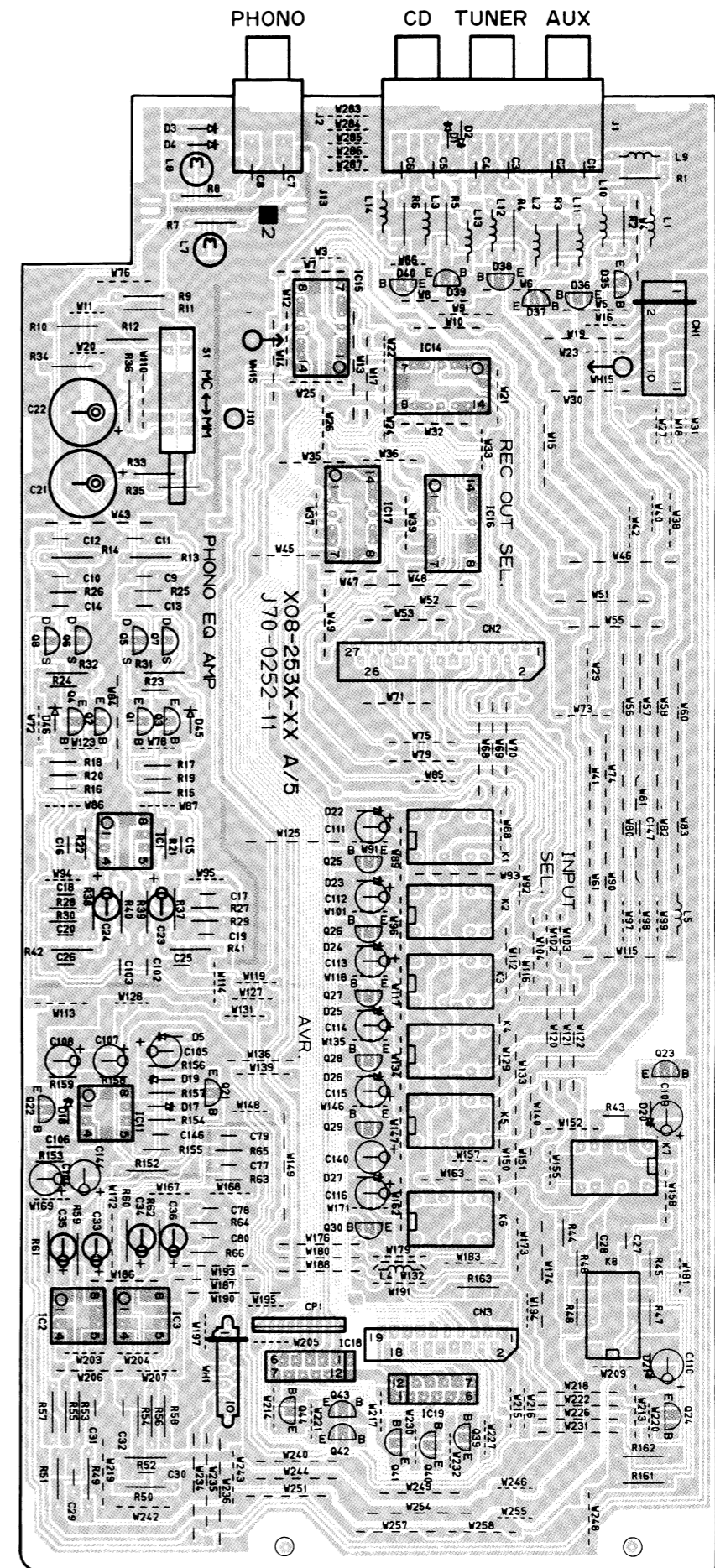

PC BOARD (Component side view)

AUDIO UNIT (X09-3661-XX)

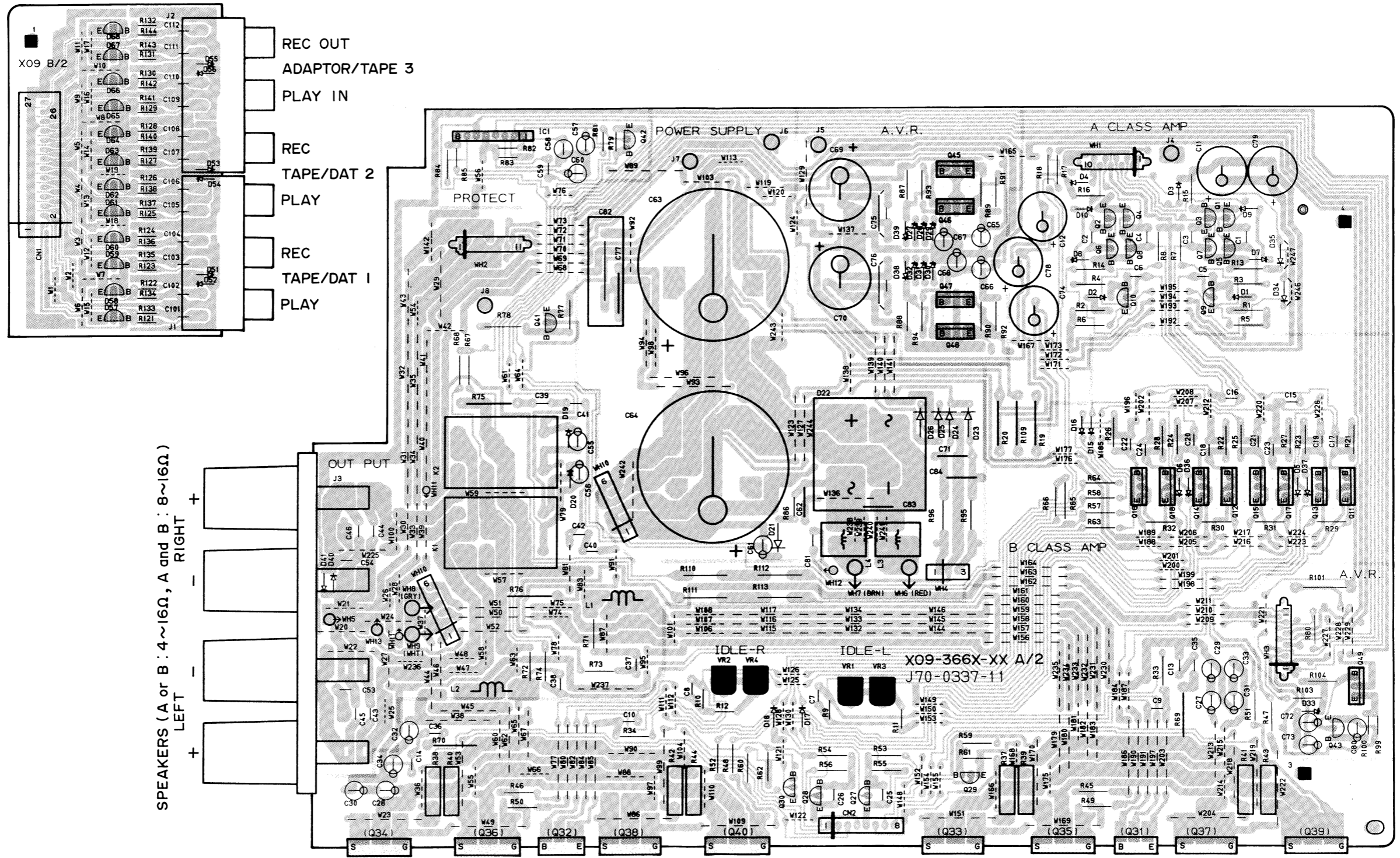

FRONT →

Refer to the schematic diagram for the values of resistors and capacitors.

PC BOARD (Component side view)

CONTROL UNIT (X11-3312-70)

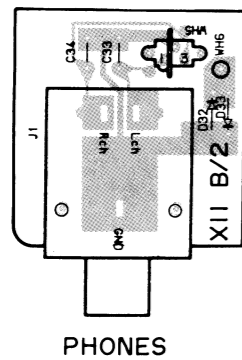
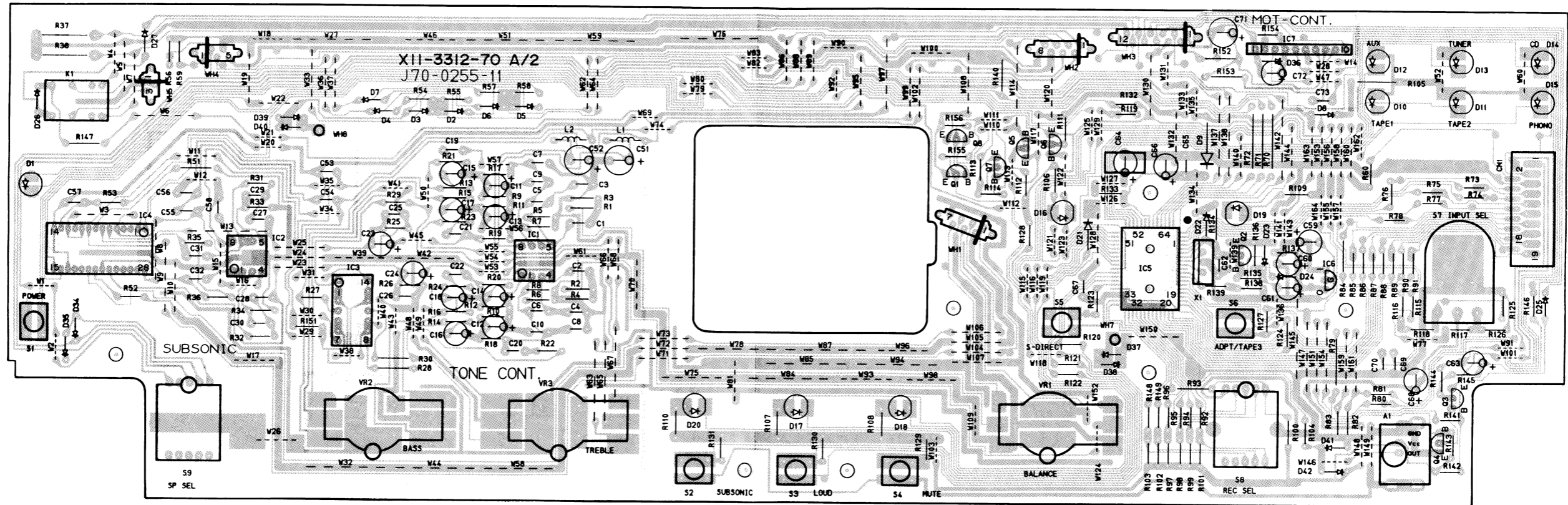

Refer to the schematic diagram for the values of resistors and capacitors.

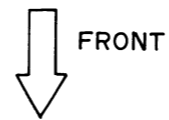

X08-253X-XX A/5

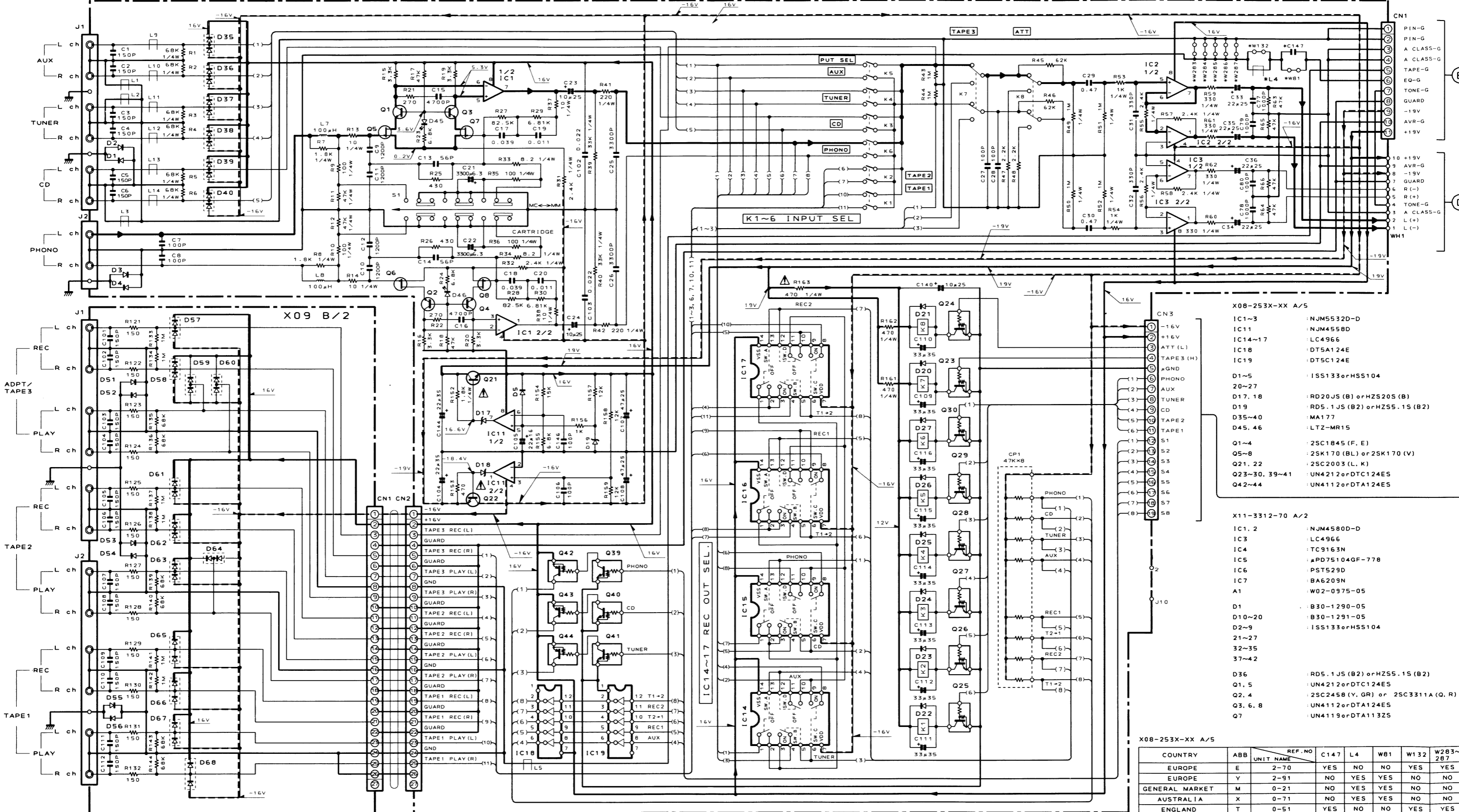

- X08-253X-XX A/5**
- IC1-3 NJM5532D-D
 - IC11 NJM4558D
 - IC14-17 LC4966
 - IC18 DT5A124E
 - IC19 DT5C124E
 - D1-5 ISS133 or HSS104
 - D20-27 RD20J5 (B) or HZS20S (B)
 - D19 RD5.1JS (B2) or HZS5.1S (B2)
 - D35-40 MA177
 - D45, 46 LTZ-MR15
 - Q1-4 2SC1845 (F, E)
 - Q5-8 2SK170 (BL) or 2SK170 (V)
 - Q21, 22 2SC2003 (L, K)
 - Q23-30, 39-41 UN4212 or DTC124ES
 - Q42-44 UN4112 or DTA124ES

- X11-3312-70 A/2**
- IC1, 2 NJM4580D-D
 - IC3 TC9163N
 - IC4 TC9163N
 - IC5 PD75104GF-778
 - IC6 PST529D
 - IC7 BA6209N
 - A1 W02-0975-05
 - D1 B30-1290-05
 - D10-20 B30-1291-05
 - D2-9 ISS133 or HSS104
 - 21-27
 - 32-35
 - 37-42
 - D36 RD5.1JS (B2) or HZS5.1S (B2)
 - Q1, 5 UN4212 or DTC124ES
 - Q2, 4 2SC2458 (Y, GR) or 2SC3311A (O, R)
 - Q3, 6, 8 UN4112 or DTA124ES
 - Q7 UN4119 or DTA1132S

X08-253X-XX A/5

COUNTRY	ABB	REF. NO	C147	L4	W81	W132	W283~287
EUROPE	E	2-70	YES	NO	NO	YES	YES
EUROPE	Y	2-91	NO	YES	YES	NO	NO
GENERAL MARKET	M	0-21	NO	YES	YES	NO	NO
AUSTRALIA	X	0-71	NO	YES	YES	NO	NO
ENGLAND	T	0-51	YES	NO	NO	YES	YES
NORTHERN EUROPE	L	2-70	YES	NO	NO	YES	YES
CANADA	P	1-01	NO	YES	YES	NO	NO

X09 B/2
D51-56 HSS104 or ISS133
D57-68 MA177

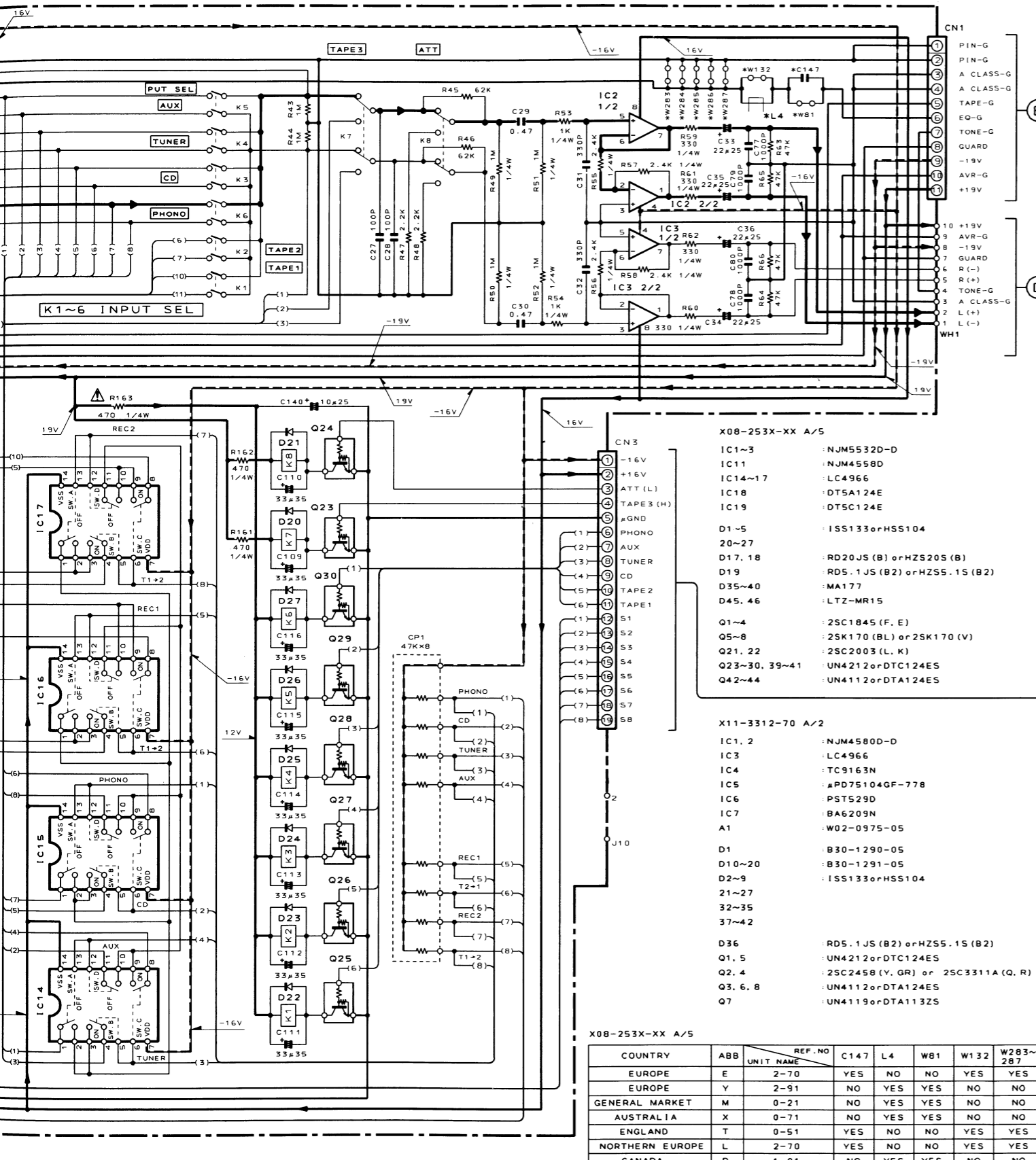

X08-253X-XX A/5

COUNTRY	ABB	UNIT NAME	REF. NO	C147	L4	W81	W132	W283~287
EUROPE	E	2-70		YES	NO	NO	YES	YES
EUROPE	Y	2-91		NO	YES	YES	NO	NO
GENERAL MARKET	M	0-21		NO	YES	YES	NO	NO
AUSTRALIA	X	0-71		NO	YES	YES	NO	NO
ENGLAND	T	0-51		YES	NO	NO	YES	YES
NORTHERN EUROPE	L	2-70		YES	NO	NO	YES	YES
CANADA	P	1-01		NO	YES	YES	NO	NO

X11-3312-70 A/2

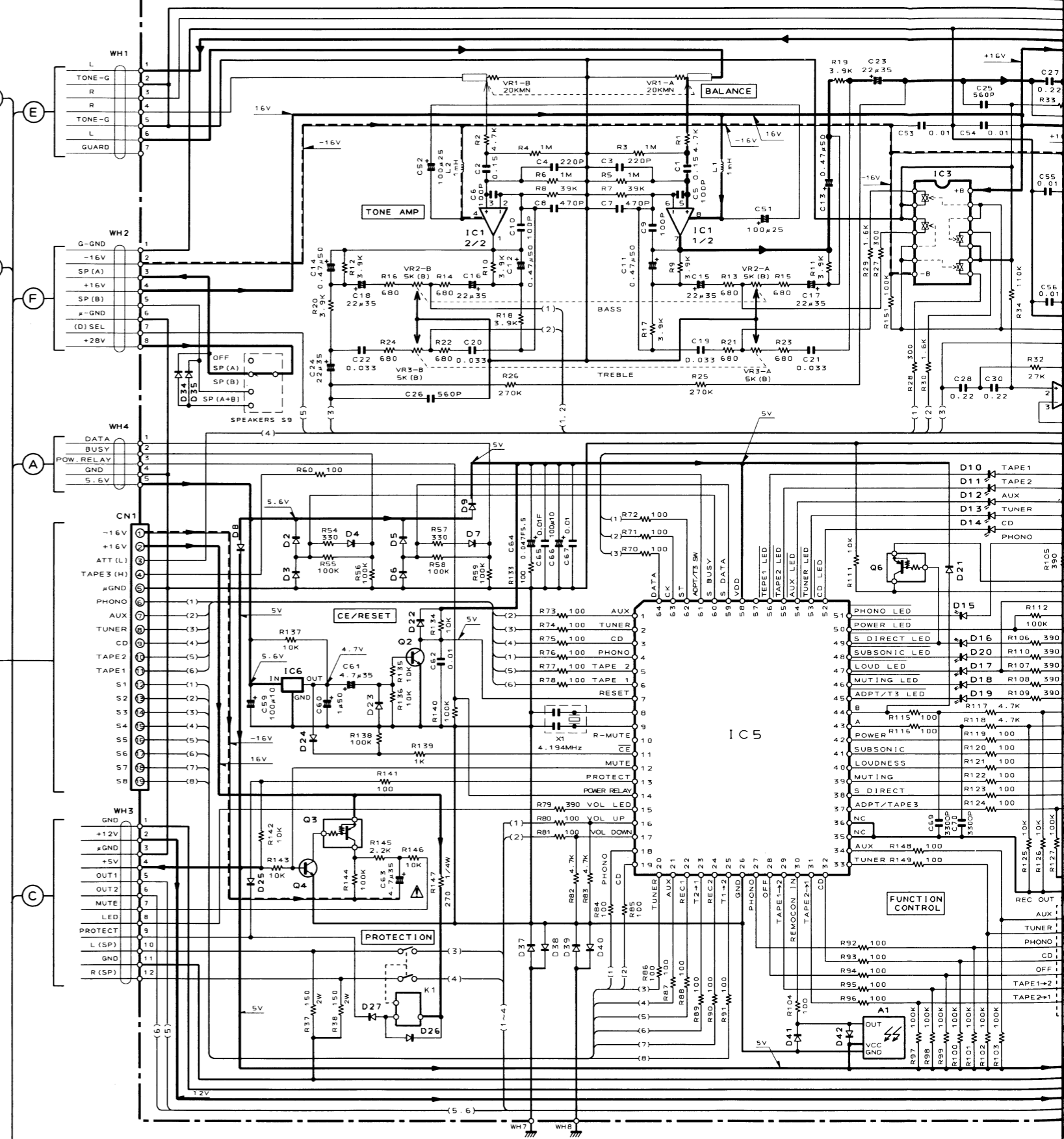

X11-3312-70 A/2

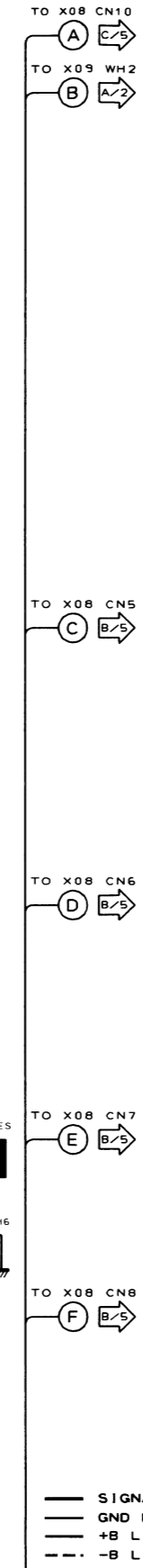
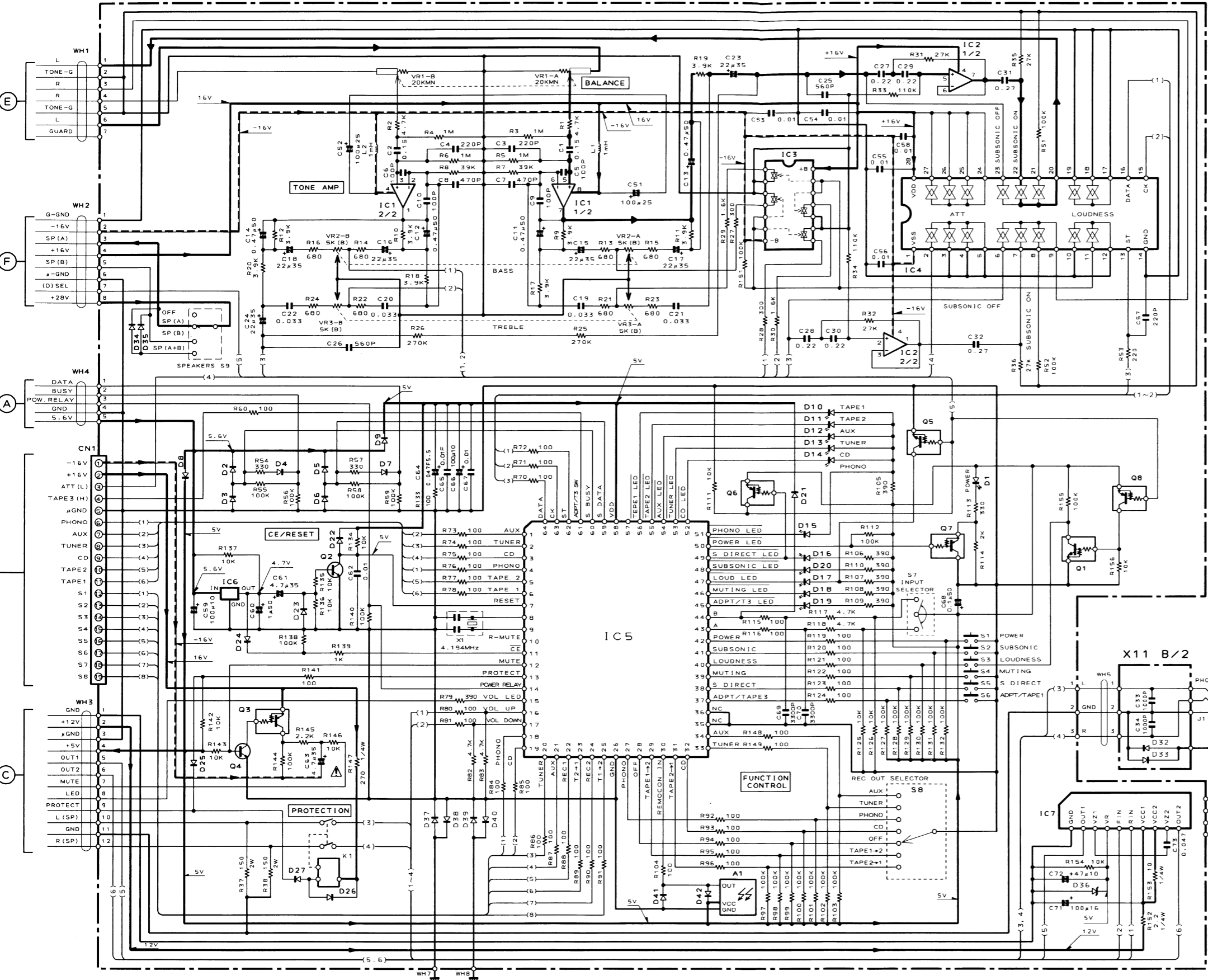

- 2SA1124
 - 2SA954
 - 2SA992
 - 2SC1845
 - 2SC2003
 - 2SC2632
 - 2SC2878
- NJM2114D
 - NJM4558D
 - NJM5532D-D
- UPD75104GF-778
- LC4966
- NJM4580D-D
- DTA124ES
 - DTC124ES
 - UN4112
 - 2SC2458
- UPC1237HA
- 2SA1535
 - 2SC3944
- PST529D
- UN4212
 - 2SC3311A
- 2SK170
- BA6209N
- 2SB1375
 - 2SB1548
 - 2SD2012
 - 2SD2374
- 2SK1530-LBP2
 - 2SJ201-LBP2
- DT5A124E
 - DT5C124E

CAUTION: For continued safety, replace safety critical components only with manufacturer's recommended parts (refer to parts list). Δ Indicates safety critical components. To reduce the risk of electric shock, leakage-current or resistance measurements shall be carried out (exposed parts are acceptably insulated from the supply circuit) before the appliance is returned to the customer.

DC voltages are as measured with a high impedance voltmeter with no signal input. Values may vary slightly due to variations between individual instruments or/and units.

Les tensions c.c. doivent être mesurées avec un voltmètre à haute impédance sans signal d'entrée. Les valeurs peuvent différer légèrement du fait des variations inhérentes aux appareils et aux instruments de mesure individuels.

Die angegebenen Gleichspannungswerte wurden mit einem hochohmigen Spannungsmesser ohne Eingangssignal gemessen. Dabei schwanken die Meßwerte aufgrund von Unterschieden zwischen einzelnen Instrumenten oder Geräten u. U. geringfügig.

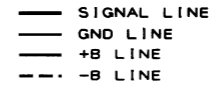

KA-7050R
KENWOOD

Y-08-4662-70

TO X11 WH4
 TO X08 CN1
 TO X11 WH3
 TO X08 WH1
 TO X11 WH1
 TO X11 WH2

X08 B/5
 IC4, 5 1N4001 (F, E) Q9-14 2SA992 (F, E) Q35 2SA954 (L, K) D6-8 1SS133 or HSS104
 IC6, 7 1N4001 (R, S) Q15-18 2SA1124 (R, S) Q36 2SC2003 (L, K) 30, 31 30, 31
 IC12 1N4001 (B) Q31-34 2SC2878 (B) Q38 UN4212 or DTC124ES D29, 34, 41, 42 RD5, 1J5 (B2) or HZ55, 15 (B2)
 D32, 33 RD15J5 (B) or HZ5155 (B)

X08-253X-XX B/5

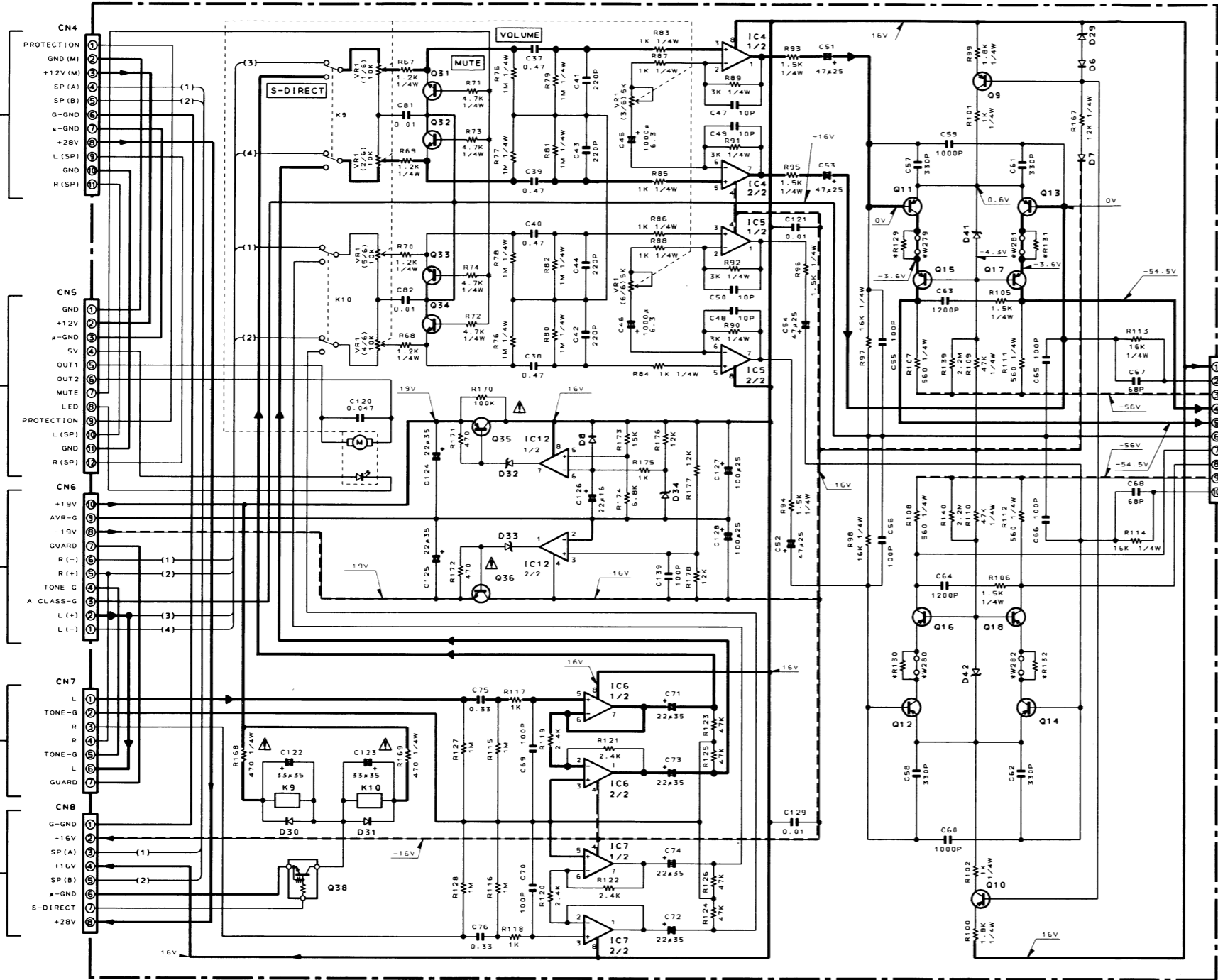

X08-253X-XX

COUNTRY	ABB	REF. NO	W34	W50	W53	W62	W64	J4	J7	J8	F1	F2	F3	T1	CN13	CN15	WH3	WH13	X08	S2	#A	#B	W124	W279	R129-132
EUROPE	E	2-70	YES	NO	NO	YES	NO	NO	NO	YES	250V, 4A	NO	250V, 2.5A	L01-7653-05	NO	YES	NO	NO	NO	NO	YES	NO	YES	NO	NO
EUROPE	Y	2-91	NO	YES	NO	YES	YES	NO	YES	NO	250V, 4A	250V, 4A	NO	L01-7653-05	YES	NO	YES	NO	YES	YES	YES	NO	NO	NO	1.6K1/4W
GENERAL MARKET	M	0-21	NO	YES	NO	YES	NO	NO	NO	YES	250V, 4A	250V, 4A	NO	L01-7653-05	YES	NO	YES	NO	YES	YES	YES	NO	NO	NO	1.6K1/4W
AUSTRALIA	X	0-71	YES	YES	NO	NO	NO	NO	NO	NO	250V, 4A	NO	NO	L01-7657-05	NO	NO	NO	YES	NO	NO	YES	NO	NO	NO	1.6K1/4W
ENGLAND	T	0-51	YES	YES	NO	NO	NO	NO	NO	NO	250V, 4A	NO	NO	L01-7657-05	NO	NO	NO	NO	NO	NO	NO	YES	NO	NO	1.6K1/4W
NORTHERN EUROPE	L	2-70	YES	NO	NO	YES	NO	NO	NO	YES	250V, 4A	NO	250V, 2.5A	L01-7653-05	NO	YES	NO	NO	NO	NO	YES	NO	NO	NO	1.6K1/4W
CANADA	P	1-01	YES	YES	NO	YES	YES	NO	YES	NO	125V, 6A	NO	NO	L01-7651-05	NO	NO	NO	NO	NO	NO	YES	NO	NO	NO	1.6K1/4W

X09-366X-XX A/2

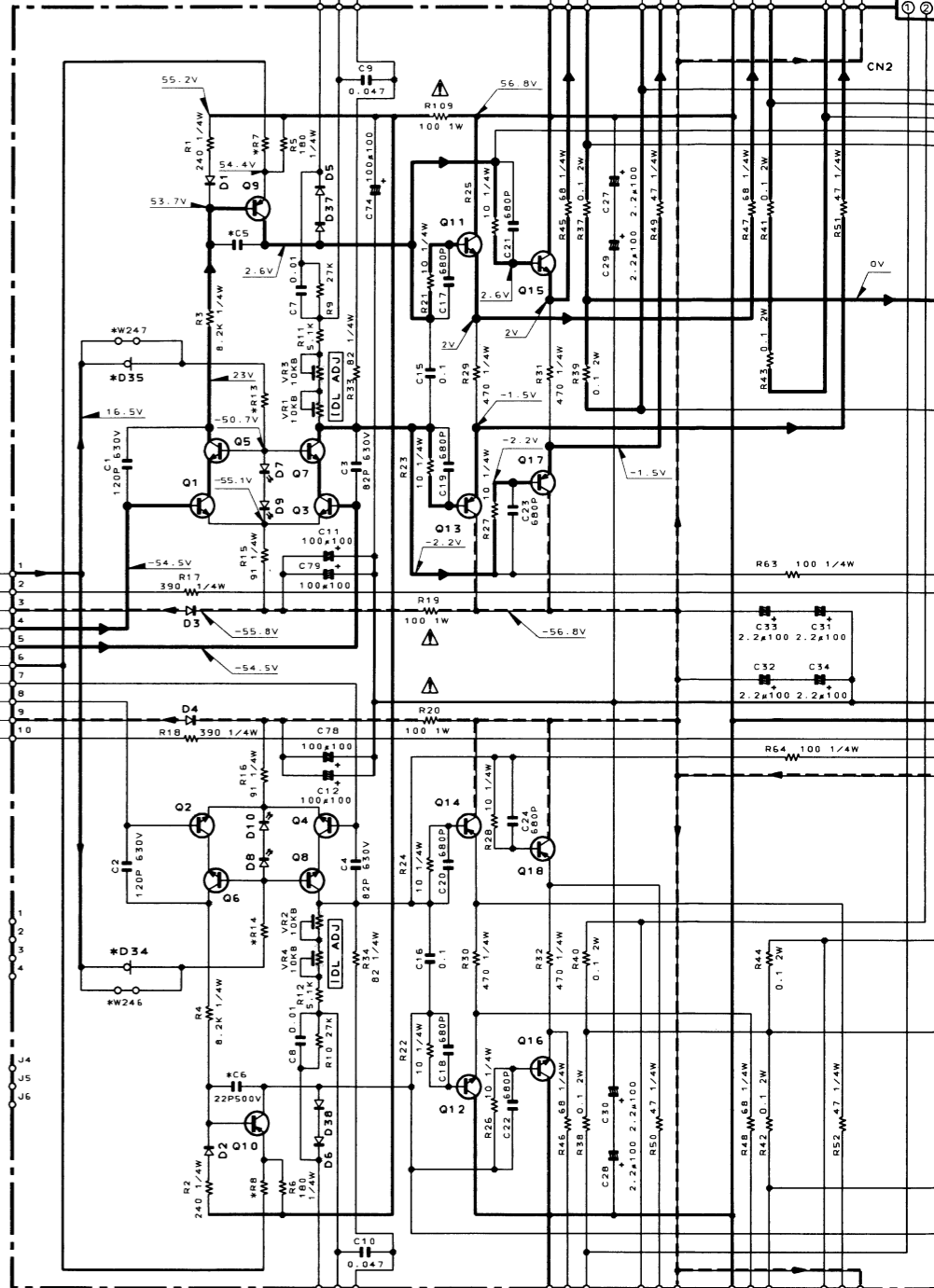

X09-366X-XX A/2

COUNTRY	ABB	REF. NO	C5, 6	C63, 64	C69, 70	C75, 76, 77	C81	C83, 84	R7, 8	R13, 14	D34, 35	L3, 4	W238-24
EUROPE	E	2-70	22P500V	C90-1981-05	2200#35	NO	4700P	NO	47K1/4W	68K1/4W	YES	NO	YES
ENGLAND	T	2-70	22P500V	C90-1981-05	2200#35	NO	4700P	NO	47K1/4W	68K1/4W	YES	NO	YES
EUROPE	Y	0-01	NO	C90-1985-05	1000#50	0.01#250V	NO	0.01#500V	43K1/4W	120K1/4W	NO	YES	NO
GENERAL MARKET	M	0-01	NO	C90-1985-05	1000#50	0.01#250V	NO	0.01#500V	43K1/4W	120K1/4W	NO	YES	NO
AUSTRALIA	X	0-01	NO	C90-1985-05	1000#50	0.01#250V	NO	0.01#500V	43K1/4W	120K1/4W	NO	YES	NO
NORTHERN EUROPE	L	1-71	22P500V	C90-1981-05	2200#35	NO	4700P	NO	47K1/4W	68K1/4W	YES	NO	YES
CANADA	P	0-01	NO	C90-1985-05	1000#50	0.01#500V	NO	0.01#500V	43K1/4W	120K1/4W	NO	YES	NO

D6~8 : ISS133 or HSS104
 30, 31
 D29, 34, 41, 42 : RD5-1JS (B2) or HZ55-1S (B2)
 D32, 33 : RD15JS (B) or HZ515S (B)

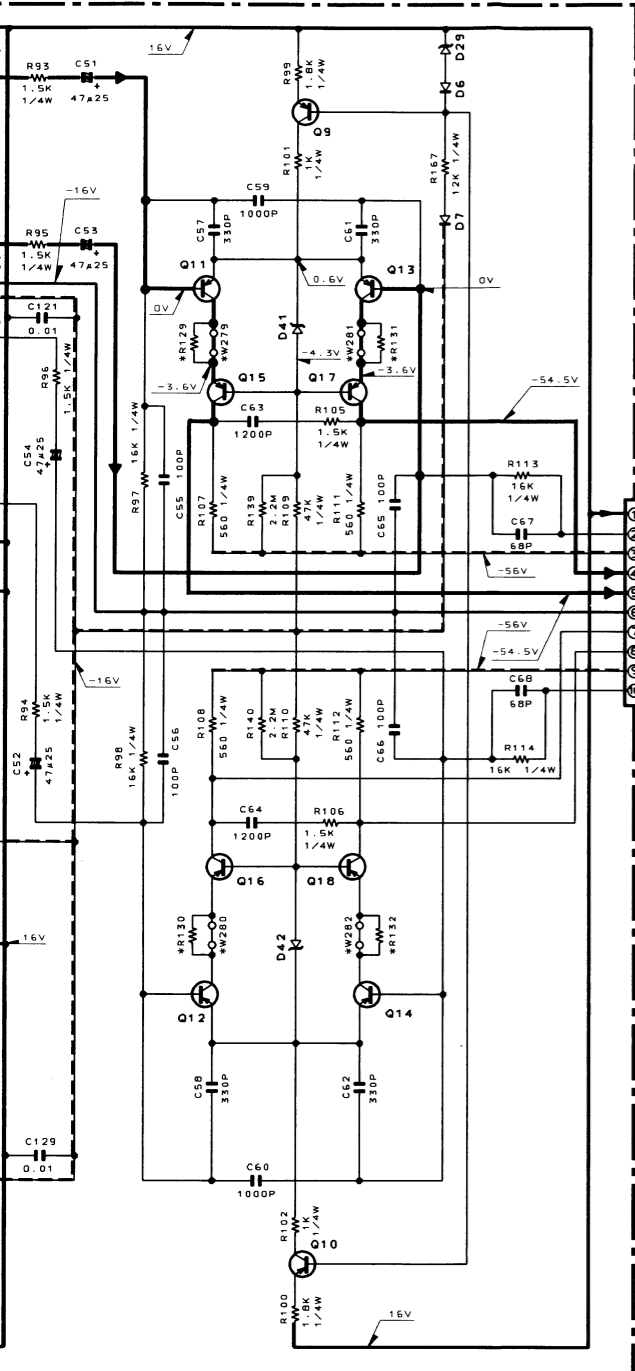

X09-366X-XX A/2

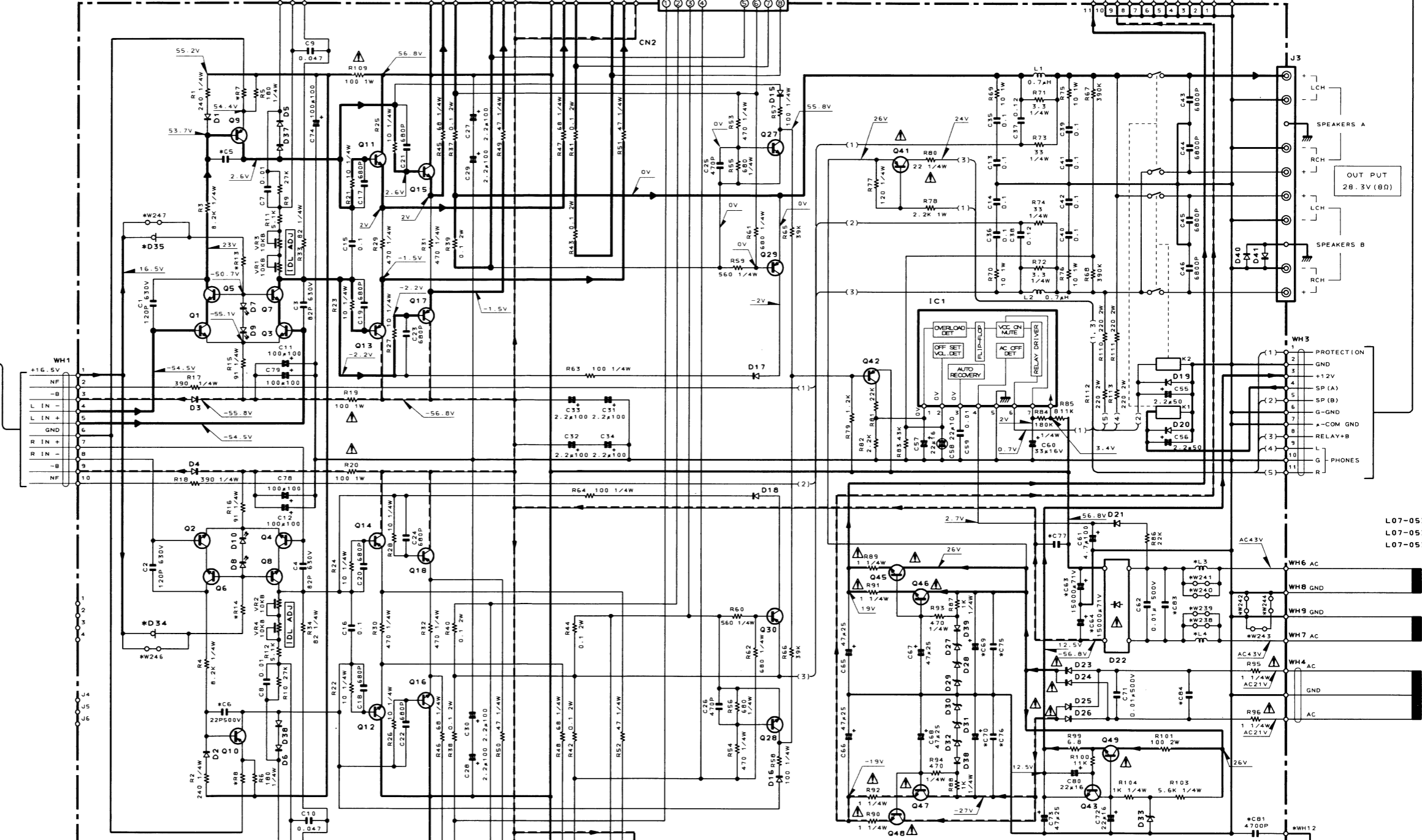

L07-0530-05 (E.L.)
 L07-0531-05 (X.T.)
 L07-0533-05 (P)

WH3	WH13	X08	S2, S3	#A	#B	W124	W279	R129~132
05	NO	NO	NO	NO	NO	NO	NO	NO
05	YES	NO	NO	YES	NO	NO	NO	1.6K1/4W
05	YES	NO	YES	YES	NO	NO	NO	1.6K1/4W
05	NO	NO	NO	NO	NO	NO	NO	1.6K1/4W
05	NO	NO	NO	NO	NO	NO	NO	NO
05	NO	NO	NO	NO	NO	NO	NO	1.6K1/4W

X09-366X-XX A/2		REF. NO	C5, 6	C63, 64	C69, 70	C75, 76, 77	C81	C83, 84	R7, 8	R13, 14	D34, 35	L3, 4	W238~244	W246	WH12
COUNTRY	ABB	UNIT NAME													
EUROPE	E	2-70	22P500V	C90-1981-05	2200*35	NO	4700P	NO	47K1/4W	68K1/4W	YES	NO	YES	NO	YES
ENGLAND	T	2-70	22P500V	C90-1981-05	2200*35	NO	4700P	NO	47K1/4W	68K1/4W	YES	NO	YES	NO	YES
EUROPE	Y	0-01	NO	C90-1985-05	1000*50	0.01*250V	NO	0.01*500V	43K1/4W	120K1/4W	NO	YES	NO	YES	NO
GENERAL MARKET	M	0-01	NO	C90-1985-05	1000*50	0.01*250V	NO	0.01*500V	43K1/4W	120K1/4W	NO	YES	NO	YES	NO
AUSTRALIA	X	0-01	NO	C90-1985-05	1000*50	0.01*250V	NO	0.01*500V	43K1/4W	120K1/4W	NO	YES	NO	YES	NO
NORTHERN EUROPE	L	1-71	22P500V	C90-1981-05	2200*35	NO	4700P	NO	47K1/4W	68K1/4W	YES	NO	YES	NO	YES
CANADA	P	0-01	NO	C90-1985-05	1000*50	0.01*500V	NO	0.01*500V	43K1/4W	120K1/4W	NO	YES	NO	YES	NO

X09 A/2		IC1	Q1~4, 27, 28	Q5~8	Q9, 10	Q11, 12, 15, 16	Q13, 14, 17, 18	Q31, 32	Q33, 34, 37, 38	Q29, 30, 42	Q41	Q45, 46, 49	Q43	Q47, 48	Q35, 36, 39, 40	D1~6, 19, 20	D36~41	D7~10	D15~18	D21, 23~26	D22	D27~32	D33	D34, 35
IC1		PC1237HA	25C1845 (F, E)	25C2632 (R, S)	25A1124 (R, S)	25C3944 (R, S)	25A1535 (R, S)	25C4137F19 (V, W)	25K1530~LBP2	25A992 (F, E)	25A954 (L, K)	25D2012 or 25D2374	25C2458 (Y, GR) or 25C3311A (O, R)	25B1375 or 25B1548	25J201~LBP2	HSS104 or ISS133	D36~41	LTZ-MR15	HSS104A or ISS131	S5688B or ISR139-100	DSF820*1	RD6, BE5 (B2) or HZ56, 8N (B2)	RD13ES (B2) or HZ513N (B2)	E-501



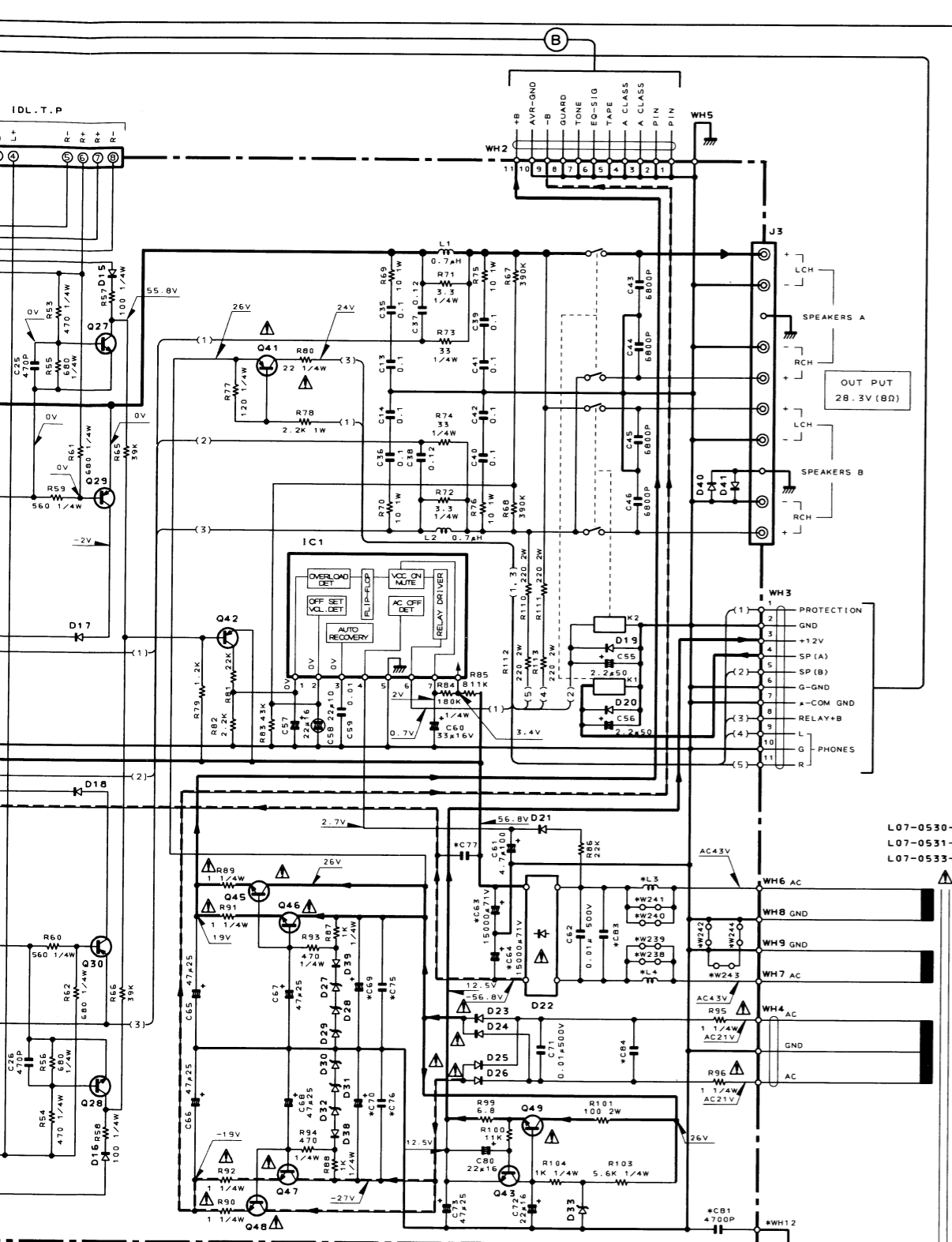

W246	WH12	X09 A/2	IC1	PC1237HA	D1~6, 19, 20	HSS104 or ISS133
NO	YES	Q1~4, 27, 28	2SC1845 (F, E)	Q29, 30, 42	2SA992 (F, E)	D36~41
NO	YES	Q5~8	2SC2632 (R, S)	Q41	2SA954 (L, K)	D7~10
YES	NO	Q9, 10	2SA1124 (R, S)	Q45, 46, 49	2SD2012 or 2SD2374	D15~18
YES	NO	Q11, 12, 15, 16	2SC3944 (R, S)	Q43	2SC2458 (Y, GR) or 2SC3311A (Q, R)	D21, 23~26
YES	NO	Q13, 14, 17, 18	2SA1535 (R, S)	Q47, 48	2SB1375 or 2SB1548	D22
NO	YES	Q31, 32	2SC4137F19 (V, W)	Q35, 36, 39, 40	2SJ201-LBP2	D27~32
YES	NO	Q33, 34, 37, 38	2SK1530-LBP2			D33
						D34, 35

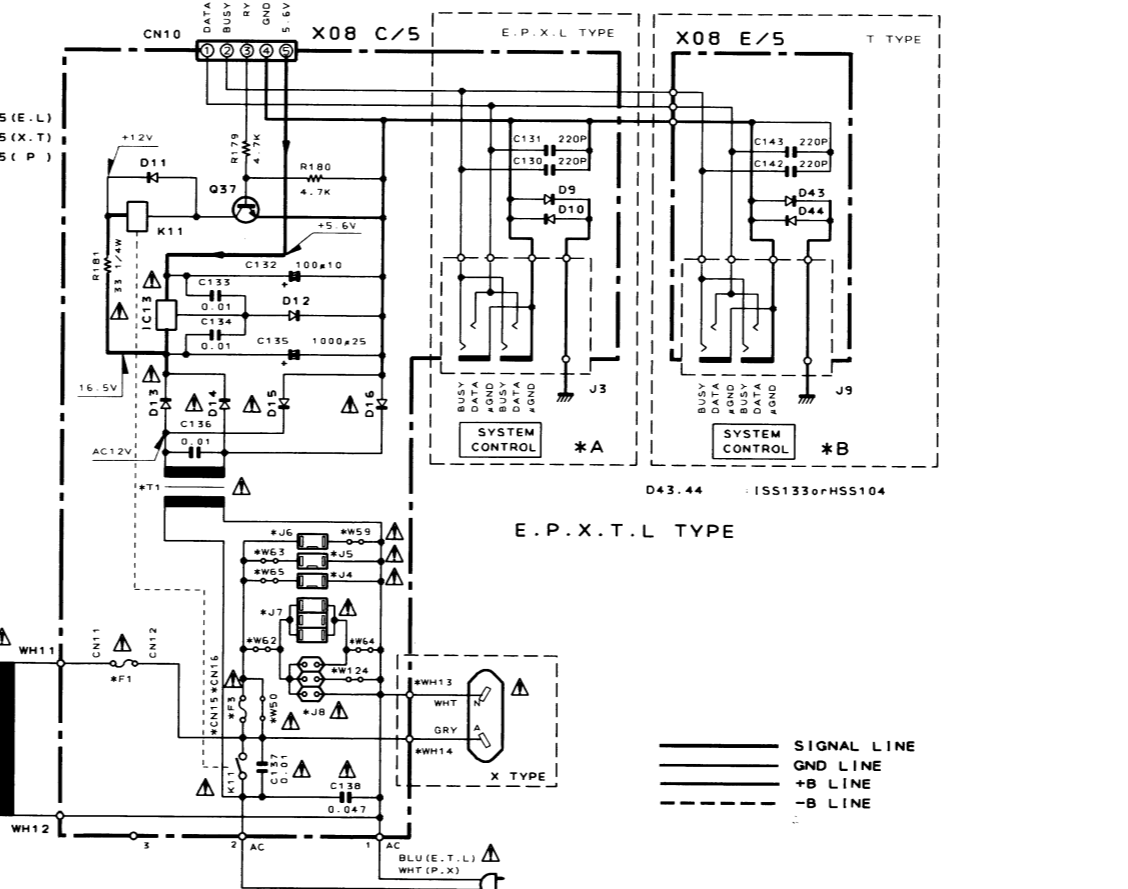
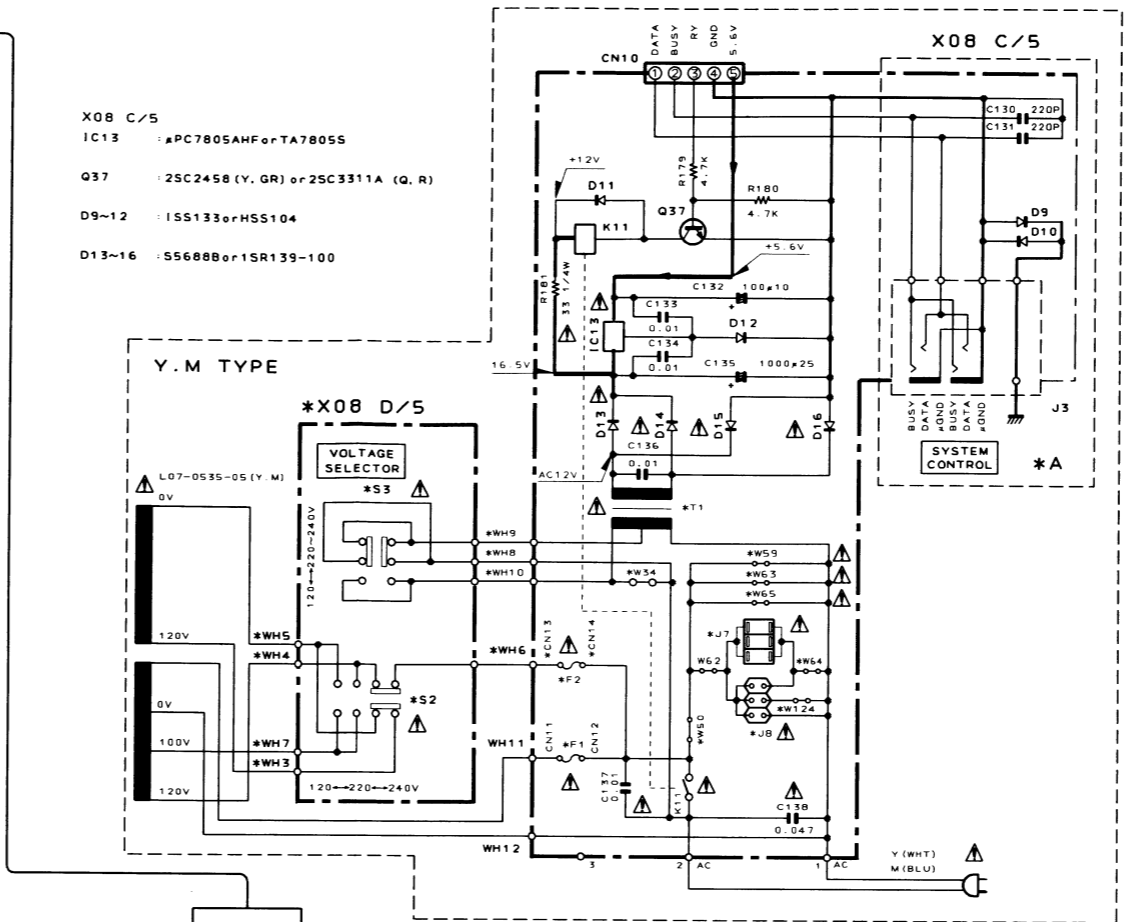

CAUTION: For continued safety, replace safety critical components only with manufacturer's recommended parts (refer to parts list). ⚠ Indicates safety critical components. To reduce the risk of electric shock, leakage-current or resistance measurements shall be carried out (exposed parts are acceptably insulated from the supply circuit) before the appliance is returned to the customer.

DC voltages are as measured with a high impedance voltmeter with no signal input. Values may vary slightly due to variations between individual instruments or/and units.

Les tensions c.c. doivent être mesurées avec un voltmètre à haute impédance sans signal d'entrée. Les valeurs peuvent différer légèrement du fait des variations inhérentes aux appareils et aux instruments de mesure individuels.

Die angegebenen Gleichspannungswerte wurden mit einem hochohmigen Spannungsmesser ohne Eingangssignal gemessen. Dabei schwanken die Meßwerte aufgrund von Unterschieden zwischen einzelnen Instrumenten oder Geräten u. U. geringfügig.

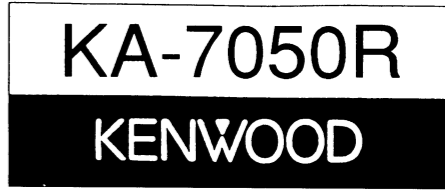

KA-7050R KA-7050R

EXPLODED VIEW

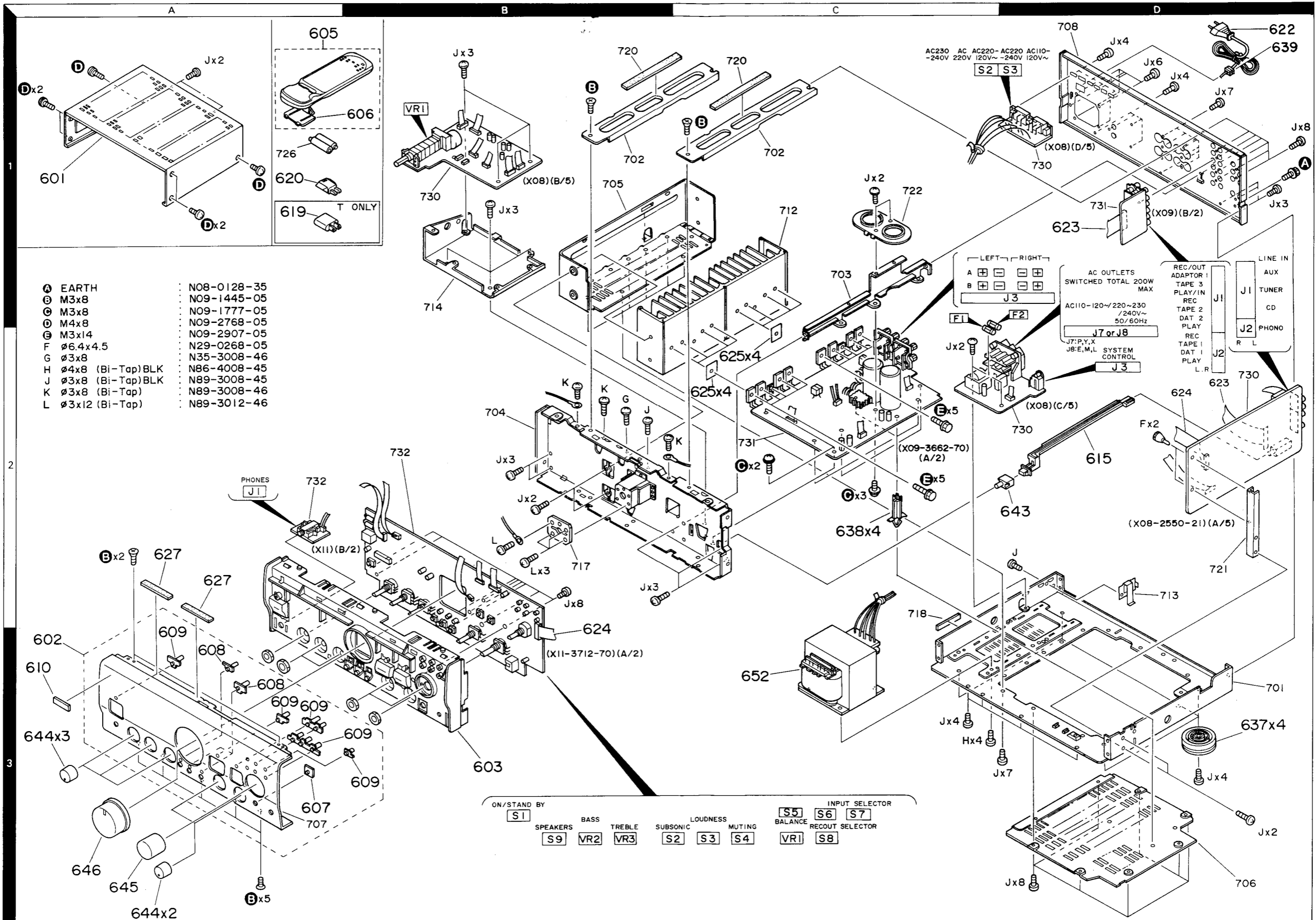

- | | | |
|---|-------------------|-------------|
| A | EARTH | N08-0128-35 |
| B | M3x8 | N09-1445-05 |
| C | M3x8 | N09-1777-05 |
| D | M4x8 | N09-2768-05 |
| E | M3x14 | N09-2907-05 |
| F | ∅6.4x4.5 | N29-0268-05 |
| G | ∅3x8 | N35-3008-46 |
| H | ∅4x8 (Bi-Tap) BLK | N86-4008-45 |
| J | ∅3x8 (Bi-Tap) BLK | N89-3008-45 |
| K | ∅3x8 (Bi-Tap) | N89-3008-46 |
| L | ∅3x12 (Bi-Tap) | N89-3012-46 |

ON/STAND BY S1

SPEAKERS S9 BASS VR2 TREBLE VR3 SUBSONIC S2 LOUDNESS S3 MUTING S4

INPUT SELECTOR S5 S6 S7 S8

BALANCE VR1 RECOUT SELECTOR S8

Parts with the exploded numbers larger than 700 are not supplied.

PARTS LIST

PREAMPLIFIER UNIT

UNIT No.	Destination
X08-2530-21	M
X08-2530-51	T
X08-2530-71	X
X08-2531-01	P
X08-2532-70	E, L
X08-2532-91	Y

AUDIO UNIT

X09-3661-71	L
X09-3662-70	E, P, Y, M, X, T

CONTROL UNIT

X11-3312-70	
-------------	--

KA-7050R

KA-7050R

PARTS LIST

× New Parts

Parts without Parts No. are not supplied.

Les articles non mentionnés dans le Parts No. ne sont pas fournis.

Teile ohne Parts No. werden nicht geliefert.

Ref. No.	Address	New Parts	Parts No.	Description	Destination	Remarks
参照番号	位置	新	部品番号	部品名/規格	仕向	備考
KA-7050R						
601	1A	*	A01-2952-01	METALLIC CABINET		
602	3A	*	A60-0239-02	PANEL ASSY		
603	3B	*	A22-1565-01	SUB PANEL		
605	1A	*	X94-1000-81	REMOTE CONTROL ASSY UNIT		
606	1B		A09-0115-13	BATTERY COVER		
607	3A	*	B11-0252-04	COLOR FILTER		
608	3A	*	B12-0205-04	INDICATOR		
609	3A, 3B	*	B12-0211-04	INDICATOR		
610	3A		B43-0287-04	KENWOOD BADGE		
-			B46-0094-03	WARRANTY CARD	Y	
-			B46-0095-03	WARRANTY CARD	Y	
-			B46-0096-33	WARRANTY CARD	X	
-			B46-0121-13	WARRANTY CARD	P	
-			B46-0122-23	WARRANTY CARD	EL	
-			B46-0143-13	WARRANTY CARD	T	
-			B58-0513-04	CAUTION CARD (PRESET220-240)	Y	
-		*	B60-0882-00	INSTRUCTION MANUAL ENGLISH		
-		*	B60-0883-00	INSTRUCTION MANUAL FRENCH	EPL	
-		*	B60-0884-00	INSTRUCTION MANUAL SPANISH	EML	
-		*	B60-0885-00	INSTRUCTION MANUAL CHINESE	M	
-		*	B60-0886-00	INSTRUCTION MANUAL GE,DU,IT	EL	
615	2D		D21-1658-03	EXTENSION SHAFT		
△ 619	1A		E03-0049-05	AC PLUG	T	
△ 620	1A		E03-0115-05	AC PLUG ADAPTER	M	
△ 622	1D		E30-0459-05	AC POWER CORD	EML	
△ 622	1D		E30-0685-05	AC POWER CORD	Y	
△ 622	1D		E30-0974-05	AC POWER CORD	P	
△ 622	1D	*	E30-2714-05	AC POWER CORD	X	
△ 622	1D		E30-2718-05	AC POWER CORD	T	
623	1D, 2D		E35-0147-05	FLAT CABLE X08(CN2)-X09(CN1)		
624	3B, 2D	*	E35-0400-05	FLAT CABLE X08(CN3)-X11(CN1)		
△ J7	2D	*	E03-0141-05	AC OUTLET	X	
625	2C		F20-1322-05	INSULATING BOARD		
627	2A		G11-1372-04	SOFT TAPE		
-		*	H50-0349-04	ITEM CARTON CASE	EPYML	
-		*	H50-0567-04	ITEM CARTON CASE	XT	
-		*	H10-5314-02	POLYSTYRENE FOAMED FIXTURE		
-		*	H10-5315-02	POLYSTYRENE FOAMED FIXTURE		
-		*	H12-2131-04	PACKING FIXTURE	XT	
-			H25-0225-04	PROTECTION BAG (850X450X0.03)	EPYMXL	
-			H25-0232-04	PROTECTION BAG (235X350X0.03)	EPYMXL	
-			H25-0651-04	PROTECTION BAG (0232 PRINTED)	T	
-			H25-0654-04	PROTECTION BAG (0225 PRINTED)	T	
637	3D		J02-1072-05	FOOT		
638	2C		J19-0581-05	UNIT HOLDER		
△ 639	1D		J42-0083-05	POWER CORD BUSHING		
-			J61-0307-05	WIRE BAND		
643	2D		K29-3405-04	KNOB MM/MC		
644	3A	*	K29-4412-04	KNOB SPEAKER, TONE, REC, OUT, SEL		
645	3A	*	K29-4414-04	KNOB INPUT SELECTOR		

L:Scandinavia

K:USA

P:Canada

Y:PX(Far East, Hawaii)

T:England

E:Europe

Y:AAFES(Europe)

X:Australia

M:Other Areas

△ indicates safety critical components.

PARTS LIST

× New Parts

Parts without Parts No. are not supplied.

Les articles non mentionnes dans le Parts No. ne sont pas fournis.

Teile ohne Parts No. werden nicht geliefert.

Ref. No. 参照番号	Address 位置	New Parts 新	Parts No. 部品番号	Description 部品名 / 規格	Desti- nation 仕 向	Re- marks 備考
646	3A	*	K29-4415-04	KNOB VOLUME CONTROL		
△ 652	3C	*	L07-0530-05	POWER TRANSFORMER	EL	
△ 652	3C	*	L07-0531-05	POWER TRANSFORMER	XT	
△ 652	3C	*	L07-0533-05	POWER TRANSFORMER	P	
△ 652	3C	*	L07-0535-05	POWER TRANSFORMER	YM	
A	1D		N08-0128-35	BINDING POST (EARTH)		
B	2A, 3A		N09-1445-05	SET SCREW (M3X8)		
C	2C		N09-1777-05	SEMS (TAPTITE SCREW)		
D	1A		N09-2768-05	SEMS (TAPTITE SCREW)(4X8)		
E	2C		N09-2907-05	SEMS (TAPTITE SCREW)(3X14)		
F	2D		N29-0268-05	PUSH RIVET		
G	2B		N35-3008-46	BINDING HEAD MACHINE SCREW		
H	3C		N86-4008-45	BINDING HEAD TAPTITE SCREW		
J	2B, 1D		N89-3008-45	BINDING HEAD TAPTITE SCREW		
K	2B, 2C		N89-3008-46	BINDING HEAD TAPTITE SCREW		
L	2B		N89-3012-46	BINDING HEAD TAPTITE SCREW		
PREAMPLIFIER UNIT (X08-2530-21: M, 0-51: T, 0-71: X, 1-01: P, 2-70: E, L, 2-91: Y)						
D45 ,46			LTZ-MR15	LED		
C1 -6			CF92FV1H151K	MF 150PF K		
C7 ,8			CF92FV1H101K	MF 100PF K		
C9 -12			CF92FV1H122J	MF 1200PF J		
C13 ,14			CC45FSL1H560J	CERAMIC 56PF J		
C15 ,16			CF92FV1H472J	MF 4700PF J		
C17 ,18			CF92FV1H393J	MF 0.039UF J		
C19 ,20			CF92FV1H113J	MF 0.011UF J		
C21 ,22			C90-1951-05	ELECTRO 3300UF 6.3WV		
C23 ,24			C90-1920-05	ELECTRO 10UF 25WV		
C25 ,26			CF92FV1H332J	MF 3300PF J		
C27 ,28			CF92FV1H101K	MF 100PF K		
C29 ,30			CF92FV1H474J	MF 0.47UF J		
C31 ,32			CF92FV1H331K	MF 330PF K		
C33 -36			C90-1921-05	ELECTRO 22UF 25WV		
C37 -40			CF92FV1H474J	MF 0.47UF J		
C41 -44			CF92FV1H221K	MF 220PF K		
C45 ,46			CE04KW0J102M	ELECTRO 1000UF 6.3WV		
C47 -50		*	C91-1462-05	FILM 10PF K		
C51 -54			C90-1922-05	ELECTRO 47UF 25WV		
C55 ,56			CF92FV1H101K	MF 100PF K		
C57 ,58			CF92FV1H331K	MF 330PF K		
C59 ,60			CF92FV1H102J	MF 1000PF J		
C61 ,62			CF92FV1H331K	MF 330PF K		
C63 ,64			CF92FV1H122J	MF 1200PF J		
C65 ,66			CF92FV1H101K	MF 100PF K		
C67 ,68		*	C91-1472-05	FILM 68PF K		
C69 ,70			CF92FV1H101K	MF 100PF K		
C71 -74			CE04KW1V220M	ELECTRO 22UF 35WV		
C75 ,76			CF92FV1H334J	MF 0.33UF J		
C77 -80			CF92FV1H102J	MF 1000PF J		
C81 ,82			CF92FV1H103J	MF 0.010UF J		
C102,103			CF92FV1H223J	MF 0.022UF J		
C104			CE04KW1V220M	ELECTRO 22UF 35WV		
C105			CE04KW1C220M	ELECTRO 22UF 16WV		
C106			CF92FV1H101K	MF 100PF K		

L:Scandinavia

K:USA

P:Canada

Y:PX(Far East, Hawaii)

T:England

E:Europe

Y:AAFES(Europe)

X:Australia

M:Other Areas

△ indicates safety critical components.

KA-7050R

PARTS LIST

× New Parts

Parts without Parts No. are not supplied.

Les articles non mentionnes dans le Parts No. ne sont pas fournis.

Teile ohne Parts No. werden nicht geliefert.

Ref. No. 参照番号	Address 位置	New Parts 新	Parts No. 部品番号	Description 部品名 / 規格	Desti- nation 仕 向	Re- marks 備考
C107, 108			CE04KW1E470M	ELECTRO 47UF 25WV		
C109-116			CE04KW1V330M	ELECTRO 33UF 35WV		
C120			CK45FF1H473Z	CERAMIC 0.047UF Z		
C121			CF92FV1H103J	MF 0.010UF J		
C122, 123			CE04KW1V330M	ELECTRO 33UF 35WV		
C124, 125			CE04KW1V220M	ELECTRO 22UF 35WV		
C126			CE04KW1C220M	ELECTRO 22UF 16WV		
C127, 128			CE04KW1E101M	ELECTRO 100UF 25WV		
C129			CF92FV1H103J	MF 0.010UF J		
C130, 131			CC45FSL1H221J	CERAMIC 220PF J	EPYMXL	
C132			CE04KW1A101M	ELECTRO 100UF 10WV		
C133, 134			CK45FF1H103Z	CERAMIC 0.010UF Z		
C135			CE04KW1E102M	ELECTRO 1000UF 25WV		
C136			CK45FF1H103Z	CERAMIC 0.010UF Z		
△ C137			C91-1439-05	FILM 0.01UF 250VAC		
C138			C91-1444-05	MF 0.047UF 250VAC		
C139			CF92FV1H101K	MF 100PF K		
C140			CE04KW1E100M	ELECTRO 10UF 25WV	T	
C142, 143			CC45FSL1H221J	CERAMIC 220PF J		
C144			CE04KW1V220M	ELECTRO 22UF 35WV		
C146			CF92FV1H101K	MF 100PF K	ETL	
C147			CF92FV1H103J	MF 0.010UF J		
CN2	2D		E40-4167-05	FLAT CABLE CONNECTOR		
CN3	2D		E40-4159-05	FLAT CABLE CONNECTOR		
J1			E13-0636-05	PHONE JACK AUX, TUNER, CD		
J2			E13-0253-05	PHONE JACK PHONE		
J3			E11-0188-05	MINIATURE PHONE JACK SYNCHRO	EPYMXL	
△ J4 -6			E03-0109-05	AC OUTLET	T	
△ J7			E03-0111-05	AC OUTLET	PY	
△ J8			E03-0131-05	AC OUTLET	EML	
J9			E11-0188-05	MINIATURE PHONE JACK SYNCHRO	T	
△ F1			F05-4025-05	FUSE (SEMKO) (250V T4A)	EXTL	
△ F1			F05-6029-05	FUSE (UL) (125V 6A)	P	
△ F1 ,2			F05-4025-05	FUSE (SEMKO) (250V T4A)	YM	
△ F3			F05-2525-05	FUSE (SEMKO) (250V T2.5A)	EL	
CN11-14			J13-0075-05	FUSE CLIP	YM	
CN11, 12			J13-0075-05	FUSE CLIP	EPXTL	
CN15, 16			J13-0075-05	FUSE CLIP	EL	
J10			J11-0098-05	WIRE CLAMPER		
L1 -3			L92-0017-05	FERRITE CORE	ETL	
L1 -5			L92-0017-05	FERRITE CORE	PYMX	
L5			L92-0017-05	FERRITE CORE	ETL	
L7 ,8			L40-1011-47	SMALL FIXED INDUCTOR(100UH, K)		
L9 -14			L92-0017-05	FERRITE CORE		
△ T1			L01-7651-05	POWER TRANSFORMER	P	
△ T1			L01-7653-05	POWER TRANSFORMER	EYML	
△ T1			L01-7657-05	POWER TRANSFORMER	XT	
CP1			R90-0804-05	MULTI-COMP 47KX8 J 1/4W		
R27 ,28			RN14BK2C8252FTS	RN 82.5K F 1/6W		
R29 ,30			RN14BK2C6811FTS	RN 6.81K F 1/6W		
R129-132		*	RN14BK2E1601FTS	RN 1.60K F 1/4W	PYMX	
R152			RD14AB2E182JTS	FL-PROOF RD 1.8K J 1/4W		
R161-163			RD14AB2E471JTS	FL-PROOF RD 470 J 1/4W		

L:Scandinavia

K:USA

P:Canada

Y:PX(Far East, Hawaii)

T:England

E:Europe

Y:AAFES(Europe)

X:Australia

M:Other Areas

△ indicates safety critical components.

PARTS LIST

× New Parts

Parts without Parts No. are not supplied.

Les articles non mentionnes dans le Parts No. ne sont pas fournis.

Teile ohne Parts No. werden nicht geliefert.

Ref. No. 参照番号	Address 位置	New Parts 新	Parts No. 部品番号	Description 部品名 / 規格	Desti- nation 仕 向	Re- marks 備考
R168,169 R181 VR1		*	RD14AB2E471JTS RD14AB2E330JTS R29-9027-05	FL-PROOF RD 470 J 1/4W FL-PROOF RD 33 J 1/4W POTENTIOMETER 10KX4 5KX2VOLUME		0
K1 -10 △ K11 S1 △ S2 △ S3		*	S76-0027-05 S76-0002-05 S40-6036-05 S31-2322-05 S31-2131-05	MAGNETIC RELAY MAGNETIC RELAY PUSH SWITCH MC/MM SLIDE SWITCH VOLTAGE SELECTOR SLIDE SWITCH VOLTAGE SELECTOR	YM YM	
D1 -12 D1 -12 D1 -8 D1 -8 D11 ,12			HSS104 1SS133 HSS104 1SS133 HSS104	DIODE DIODE DIODE DIODE DIODE	EPYMXL EPYMXL T T T	
D11 ,12 D13 -16 D13 -16 D17 ,18 D17 ,18			1SS133 S5688B 1SR139-100 HZS20S(B) RD20JS(B)	DIODE DIODE DIODE ZENER DIODE ZENER DIODE	T	
D19 D19 D20 -27 D20 -27 D29			HZS5.1S(B2) RD5.1JS(B2) HSS104 1SS133 HZS5.1S(B2)	ZENER DIODE ZENER DIODE DIODE DIODE ZENER DIODE		
D29 D30 ,31 D30 ,31 D32 ,33 D32 ,33			RD5.1JS(B2) HSS104 1SS133 HZS15S(B) RD15JS(B)	ZENER DIODE DIODE DIODE ZENER DIODE ZENER DIODE		
D34 D34 D35 -40 D41 ,42 D41 ,42			HZS5.1S(B2) RD5.1JS(B2) MA177 HZS5.1S(B2) RD5.1JS(B2)	ZENER DIODE ZENER DIODE DIODE ZENER DIODE ZENER DIODE		
D43 ,44 D43 ,44 IC1 -3 IC4 ,5 IC6 ,7		*	HSS104 1SS133 NJM5532D-D NJM2114D NJM4580D-D	DIODE DIODE IC(OP AMP X2) IC(OP AMP X2) IC(OP AMP X2)	T T	
IC11,12 IC13 IC13 IC14-17 IC18		*	NJM4558D TA7805S UPC7805AHF LC4966 DT5A124E	IC(OP AMP X2) IC(VOLTAGE REGULATOR/ +5V) IC(VOLTAGE REGULATOR/ +5V) IC(CMOS LOGIC BILATERAL SW) IC(TRANSISTOR ARRAY)		
IC19 Q1 -4 Q5 -8 Q5 -8 Q9 -14			DT5C124E 2SC1845(F,E) 2SK170(BL) 2SK170(V) 2SA992(F,E)	IC(TRANSISTOR ARRAY) TRANSISTOR FET FET TRANSISTOR		
Q15 -18 Q21 ,22 Q23 -30 Q23 -30 Q31 -34 Q35			2SA1124(R,S) 2SC2003(L,K) DTC124ES UN4212 2SC2878(B) 2SA954(L,K)	TRANSISTOR TRANSISTOR DIGITAL TRANSISTOR DIGITAL TRANSISTOR TRANSISTOR TRANSISTOR		

L:Scandinavia

K:USA

P:Canada

Y:PX(Far East, Hawaii)

T:England

E:Europe

Y:AAFES(Europe)

X:Australia

M:Other Areas

△ indicates safety critical components.

KA-7050R

PARTS LIST

× New Parts

Parts without Parts No. are not supplied.

Les articles non mentionnes dans le Parts No. ne sont pas fournis.

Teile ohne Parts No. werden nicht geliefert.

Ref. No. 参照番号	Address 位置	New Parts 新	Parts No. 部品番号	Description 部品名 / 規格	Desti- nation 仕 向	Re- marks 備考
Q36			2SC2003(L, K)	TRANSISTOR		
Q37			2SC2458(Y, GR)	TRANSISTOR		
Q37			2SC3311A(Q, R)	TRANSISTOR		
Q38 -41			DTC124ES	DIGITAL TRANSISTOR		
Q38 -41			UN4212	DIGITAL TRANSISTOR		
Q42 -44			DTA124ES	DIGITAL TRANSISTOR		
Q42 -44			UN4112	DIGITAL TRANSISTOR		
AUDIO UNIT (X09-3661-71: L, 2-70: E, P, Y, M, X, T)						
D7 -10			LTZ-MR15	LED		
C1 ,2		*	C91-1475-05	FILM 120PF J		
C3 ,4		*	C91-1473-05	FILM 82PF K		
C5 ,6			CC45FSL2H220J	CERAMIC 22PF J	ETL	
C7 ,8			CF92FV1H103J	MF 0.010UF J		
C9 ,10			CF92FV1H473J	MF 0.047UF J		
C11 ,12			CE04KW2A101M	ELECTRO 100UF 100WV		
C13 -16			CF92FV1H104J	MF 0.10UF J		
C17 -24			CF92FV1H681J	MF 680PF J		
C25 ,26			CF92FV1H471J	MF 470PF J		
C27 -34			CE04KW2A2R2M	ELECTRO 2.2UF 100WV		
C35 ,36			CF92FV1H104J	MF 0.10UF J		
C37 ,38			CF92FV1H124J	MF 0.12UF J		
C39 -42			CF92FV1H104J	MF 0.10UF J		
C43 -46			CF92FV1H682J	MF 6800PF J		
C55 ,56			CE04KW1H2R2M	ELECTRO 2.2UF 50WV		
C57			CE04KW1C220M	ELECTRO 22UF 16WV		
C58			CE04HW1A220M	NP-ELEC 22UF 10WV		
C59			CK45FF1H103Z	CERAMIC 0.010UF Z		
C60			CE04KW1C330M	ELECTRO 33UF 16WV		
C61			CE04KW2A4R7M	ELECTRO 4.7UF 100WV		
C62			CK45FE2H103P	CERAMIC 0.010UF P		
C63 ,64		*	C90-1981-05	ELECTRO 15000UF 71WV	ETL	
C63 ,64		*	C90-1985-05	ELECTRO 15000UF 71WV	PYMX	
C65 -68			CE04KW1E470M	ELECTRO 47UF 25WV		
C69 ,70			CE04KW1H102M	ELECTRO 1000UF 50WV	PYMX	
C69 ,70			CE04KW1V222M	ELECTRO 2200UF 35WV	ETL	
C71			CK45FE2H103P	CERAMIC 0.010UF P		
C72			CE04KW1C220M	ELECTRO 22UF 16WV		
C73			CE04KW1E470M	ELECTRO 47UF 25WV		
C74			CE04KW2A101M	ELECTRO 100UF 100WV		
△ C75 -77			C91-0971-05	FILM 0.01UF 250WV	PYMX	
C78 ,79			CE04KW2A101M	ELECTRO 100UF 100WV		
C80			CE04KW1C220M	ELECTRO 22UF 16WV		
C83 ,84			CK45FE2H103P	CERAMIC 0.010UF P	PYMX	
C101-112			CF92FV1H151K	MF 150PF K		
CN1	1D		E40-4207-05	FLAT CABLE CONNECTOR		
J1 ,2			E13-0636-05	PHONE JACK ADAPTOR/TAPE1,2,3		
J3			E20-0839-15	SCREW TERMINAL BOARD SPEAKERS	EPYMX	
J3		*	E70-0029-05	SCREW TERMINAL BOARD SPEAKERS	L	
J4 -6			J11-0098-05	WIRE CLAMPER		
L1 ,2		*	L39-1318-05	PHASE COMPENSATION COIL		
L3 ,4			L39-0085-05	PHASE COMPENSATION COIL	PYMX	
R1 ,2		*	RD14AB2E241JTS	FL-PROOF RD 240 J 1/4W		

L:Scandinavia

K:USA

P:Canada

Y:PX(Far East, Hawaii)

T:England

E:Europe

Y:AAFES(Europe)

X:Australia

M:Other Areas

△ indicates safety critical components.

PARTS LIST

× New Parts

Parts without Parts No. are not supplied.

Les articles non mentionnes dans le Parts No. ne sont pas fournis.

Teile ohne Parts No. werden nicht geliefert.

Ref. No. 参照番号	Address 位置	New Parts 新	Parts No. 部品番号	Description 部品名 / 規格	Desti- nation 仕向	Re- marks 備考
R3 ,4			RD14AB2E822JTS	FL-PROOF RD 8.2K J 1/4W		
R5 ,6			RD14AB2E181JTS	FL-PROOF RD 180 J 1/4W		
R15 ,16		*	RD14AB2E910JTS	FL-PROOF RD 91 J 1/4W		
R19 ,20			RS14GB3A101JKW	FL-PROOF RS 100 J 1W		
R21 -28			RD14AB2E100JTS	FL-PROOF RD 10 J 1/4W		
R29 -32			RD14AB2E471JTS	FL-PROOF RD 470 J 1/4W		
R33 ,34		*	RD14AB2E820JTS	FL-PROOF RD 82 J 1/4W		
R37 -44			R92-0205-05	METAL-PLATE 0.1 K 2W		
R45 -48			RD14AB2E680JTS	FL-PROOF RD 68 J 1/4W		
R49 -52			RD14AB2E470JTS	FL-PROOF RD 47 J 1/4W		
R53 ,54			RD14AB2E471JTS	FL-PROOF RD 470 J 1/4W		
R55 ,56			RD14AB2E681JTS	FL-PROOF RD 680 J 1/4W		
R57 ,58			RD14AB2E101JTS	FL-PROOF RD 100 J 1/4W		
R59 ,60			RD14AB2E561JTS	FL-PROOF RD 560 J 1/4W		
R61 ,62			RD14AB2E681JTS	FL-PROOF RD 680 J 1/4W		
R63 ,64			RD14AB2E101JTS	FL-PROOF RD 100 J 1/4W		
R69 ,70			RS14GB3A100JKW	FL-PROOF RS 10 J 1W		
R71 ,72		*	RD14AB2E3R3JTS	FL-PROOF RD 3.3 J 1/4W		
R73 ,74			RD14AB2E330JTS	FL-PROOF RD 33 J 1/4W		
R75 ,76			RS14GB3A100JKW	FL-PROOF RS 10 J 1W		
R77			RD14AB2E121JTS	FL-PROOF RD 120 J 1/4W		
R78			RS14DB3A222JTE	FL-PROOF RS 2.2K J 1W		
R80			RD14AB2E220JTS	FL-PROOF RD 22 J 1/4W		
R87 ,88			RD14AB2E102JTS	FL-PROOF RD 1.0K J 1/4W		
R89 -92		*	RD14AB2E3R3JTS	FL-PROOF RD 3.3 J 1/4W		
R93 ,94			RD14AB2E471JTS	FL-PROOF RD 470 J 1/4W		
R95 ,96			RD14AB2E1R0JTS	FL-PROOF RD 1.0 J 1/4W		
R101			RS14DB3D101JTE	FL-PROOF RS 100 J 2W		
R103		*	RD14AB2E562JTS	FL-PROOF RD 5.6K J 1/4W		
R109			RS14GB3A101JKW	FL-PROOF RS 100 J 1W		
R110-113			RS14DB3D221JTE	FL-PROOF RS 220 J 2W		
VR1 -4			R12-3685-05	TRIMMING POT.(10K) IDL ADJ		
K1 ,2			S51-2096-05	MAGNETIC RELAY		
D1 -6			HSS104	DIODE		
D1 -6			1SS133	DIODE		
D15 -18			HSS104A	DIODE		
D15 -18			1SS131	DIODE		
D19 ,20			HSS104	DIODE		
D19 ,20			1SS133	DIODE		
D21			S5688B	DIODE		
D21			1SR139-100	DIODE		
D22			D5FB20*1	DIODE		
D23 -26			S5688B	DIODE		
D23 -26			1SR139-100	DIODE		
D27 -32			HZS6.8N(B2)	ZENER DIODE		
D27 -32			RD6.8ES(B2)	ZENER DIODE		
D33			HZS13N(B2)	ZENER DIODE		
D33			RD13ES(B2)	ZENER DIODE		
D34 ,35		*	E-501	CONSTANT CURRENT DIODE	ETL	
D36 -41			HSS104	DIODE		
D36 -41			1SS133	DIODE		
D51 -56			HSS104	DIODE		
D51 -56			1SS133	DIODE		

L:Scandinavia

K:USA

P:Canada

Y:PX(Far East, Hawaii)

T:England

E:Europe

Y:AAFES(Europe)

X:Australia

M:Other Areas

△ indicates safety critical components.

KA-7050R

PARTS LIST

× New Parts

Parts without Parts No. are not supplied.

Les articles non mentionnes dans le Parts No. ne sont pas fournis.

Teile ohne Parts No. werden nicht geliefert.

Ref. No. 参照番号	Address 位置	New Parts 新	Parts No. 部品番号	Description 部品名 / 規格	Desti- nation 仕向	Re- marks 備考
D57 -68			MA177	DIODE		
IC1			UPC1237HA	IC(POWER AMP)		
Q1 -4			2SC1845(F,E)	TRANSISTOR		
Q5 -8			2SC2632(R,S)	TRANSISTOR		
Q9 ,10			2SA1124(R,S)	TRANSISTOR		
Q11 ,12			2SC3944(R,S)	TRANSISTOR		
Q13 ,14			2SA1535(R,S)	TRANSISTOR		
Q15 ,16			2SC3944(R,S)	TRANSISTOR		
Q17 ,18			2SA1535(R,S)	TRANSISTOR		
Q27 ,28			2SC1845(F,E)	TRANSISTOR		
Q29 ,30			2SA992(F,E)	TRANSISTOR		
Q31 ,32			2SC4137F19(V,W)	TRANSISTOR		
Q33 ,34		*	2SK1530-LBP2	FET		
Q35 ,36		*	2SJ201-LBP2	FET		
Q37 ,38		*	2SK1530-LBP2	FET		
Q39 ,40		*	2SJ201-LBP2	FET		
Q41			2SA954(L,K)	TRANSISTOR		
Q42			2SA992(F,E)	TRANSISTOR		
Q43			2SC2458(Y,GR)	TRANSISTOR		
Q43			2SC3311A(Q,R)	TRANSISTOR		
Q45 ,46			2SD2012	TRANSISTOR		
Q45 ,46			2SD2374	TRANSISTOR		
Q47 ,48			2SB1375	TRANSISTOR		
Q47 ,48			2SB1548	TRANSISTOR		
Q49			2SD2012	TRANSISTOR		
Q49			2SD2374	TRANSISTOR		
CONTROL UNIT (X11-3312-70)						
D1			B30-1290-05	LED (LN21RCASLX(U)-(TA4))		
D10 -20			B30-1291-05	LED (LN21CPSLX(V)-(TA4))		
C1 ,2			CF92FV1H154J	MF 0.15UF J		
C3 ,4			CF92FV1H221K	MF 220PF K		
C5 ,6			CF92FV1H101K	MF 100PF K		
C7 ,8			CF92FV1H471J	MF 470PF J		
C9 ,10			CF92FV1H101K	MF 100PF K		
C11 -14			CE04KW1HR47M	ELECTRO 0.47UF 50WV		
C15 -18			CE04KW1V220M	ELECTRO 22UF 35WV		
C19 -22			CF92FV1H333J	MF 0.033UF J		
C23 ,24			CE04KW1V220M	ELECTRO 22UF 35WV		
C25 ,26			CF92FV1H561J	MF 560PF J		
C27 -30			CF92FV1H224J	MF 0.22UF J		
C31 ,32			CF92FV1H274J	MF 0.27UF J		
C33 ,34			CF92FV1H102J	MF 1000PF J		
C51 ,52			CE04KW1E101M	ELECTRO 100UF 25WV		
C53 -56			CF92FV1H103J	MF 0.010UF J		
C57			CC45FSL1H221J	CERAMIC 220PF J		
C58			CF92FV1H103J	MF 0.010UF J		
C59			CE04KW1A101M	ELECTRO 100UF 10WV		
C60			CE04KW1H010M	ELECTRO 1.0UF 50WV		
C61			CE04KW1V4R7M	ELECTRO 4.7UF 35WV		
C62			CK45FF1H103Z	CERAMIC 0.010UF Z		
C63			CE04KW1V4R7M	ELECTRO 4.7UF 35WV		
C64			C90-1826-05	BACKUP 0.047F 5.5WV		
C65			CK45FF1H103Z	CERAMIC 0.010UF Z		
C66			CE04KW1A101M	ELECTRO 100UF 10WV		

L:Scandinavia

K:USA

P:Canada

Y:PX(Far East, Hawaii)

T:England

E:Europe

Y:AAFES(Europe)

X:Australia

M:Other Areas

 indicates safety critical components.

PARTS LIST

× New Parts

Parts without Parts No. are not supplied.

Les articles non mentionnes dans le Parts No. ne sont pas fournis.

Teile ohne Parts No. werden nicht geliefert.

Ref. No. 参照番号	Address 位置	New Parts 新	Parts No. 部品番号	Description 部品名 / 規格	Desti- nation 仕 向	Re- marks 備考
C67			CK45FF1H103Z	CERAMIC 0.010UF Z		
C68			CE04KW1HOR1M	ELECTRO 0.1UF 50WV		
C69 ,70			CK45FB1H332K	CERAMIC 3300PF K		
C71			CE04KW1C101M	ELECTRO 100UF 16WV		
C72			CE04KW1A470M	ELECTRO 47UF 10WV		
C73			CK45FF1H473Z	CERAMIC 0.047UF Z		
CN1	3B		E40-4199-05	FLAT CABLE CONNCTOR		
J1			E11-0208-05	PHONE JACK PHONES		
L1 ,2			L40-1021-14	SMALL FIXED INDUCTOR(1.0MH,K)		
X1			L78-0267-05	RESONATOR 4.194MHZ		
R37 ,38			RS14DB3D151JTE	FL-PROOF RS 150 J 2W		
R147			RD14AB2E271JTS	FL-PROOF RD 270 J 1/4W		
R152			RD14AB2E2R2JTS	FL-PROOF RD 2.2 J 1/4W		
R153			RD14AB2E100JTS	FL-PROOF RD 10 J 1/4W		
VR1		*	R06-3076-05	POTENTIOMETER(20K) BALANCE		
VR2 ,3		*	R06-2027-05	POTENTIOMETER(5K) BASS, TREBLE		
K1		*	S76-0027-05	MAGNETIC RELAY		
S1 -6		*	S40-1064-05	PUSH SWITCH KEY BOARD		
S8		*	S60-0014-05	ROTARY SWITCH REC OUT SELECTOR		
S9		*	S60-0013-05	ROTARY SWITCH SPEAKERS		
S7		*	T99-0525-05	ROTARY ENCODER INPUT SELECTOR		
D2 -9			HSS104	DIODE		
D2 -9			1SS133	DIODE		
D21 -27			HSS104	DIODE		
D21 -27			1SS133	DIODE		
D32 -35			HSS104	DIODE		
D32 -35			1SS133	DIODE		
D36			HZS5.1S(B2)	ZENER DIODE		
D36			RD5.1JS(B2)	ZENER DIODE		
D37 -42			HSS104	DIODE		
D37 -42			1SS133	DIODE		
IC1 ,2			NJM4580D-D	IC(OP AMP X2)		
IC3			LC4966	IC(CMOS LOGIC BILATERAL SW)		
IC4			TC9163N	IC(BILATERAL SWITCH X16)		
IC5			UPD75104GF-778	IC(4BIT MICROPROCESSOR)		
IC6			PST529D	IC(SYSTEM RESET)		
IC7			BA6209N	IC(MOTOR DRIVER)		
Q1			DTC124ES	DIGITAL TRANSISTOR		
Q1			UN4212	DIGITAL TRANSISTOR		
Q2			2SC2458(Y,GR)	TRANSISTOR		
Q2			2SC3311A(Q,R)	TRANSISTOR		
Q3			DTA124ES	DIGITAL TRANSISTOR		
Q3			UN4112	DIGITAL TRANSISTOR		
Q4			2SC2458(Y,GR)	TRANSISTOR		
Q4			2SC3311A(Q,R)	TRANSISTOR		
Q5			DTC124ES	DIGITAL TRANSISTOR		
Q5			UN4212	DIGITAL TRANSISTOR		
Q6			DTA124ES	DIGITAL TRANSISTOR		
Q6			UN4112	DIGITAL TRANSISTOR		
Q7			DTA113ZS	DIGITAL TRANSISTOR		
Q7			UN4119	DIGITAL TRANSISTOR		

L:Scandinavia

K:USA

P:Canada

Y:PX(Far East, Hawaii)

T:England

E:Europe

Y:AAFES(Europe)

X:Australia

M:Other Areas

 indicates safety critical components.

KA-7050R

PARTS LIST

× New Parts

Parts without Parts No. are not supplied.

Les articles non mentionnés dans le Parts No. ne sont pas fournis.

Teile ohne Parts No. werden nicht geliefert.

Ref. No. 参照番号	Address 位置	New Parts 新	Parts No. 部品番号	Description 部品名 / 規格	Desti- nation 仕向	Re- marks 備考
Q8			DTA124ES	DIGITAL TRANSISTOR		
Q8			UN4112	DIGITAL TRANSISTOR		
A1			W02-0975-05	ELECTRIC CIRCUIT MODULE		

L:Scandinavia

K:USA

P:Canada

Y:PX(Far East, Hawaii)

T:England

E:Europe

Y:AAFES(Europe)

X:Australia

M:Other Areas

 indicates safety critical components.

REMOTE CONTROL OPERATION

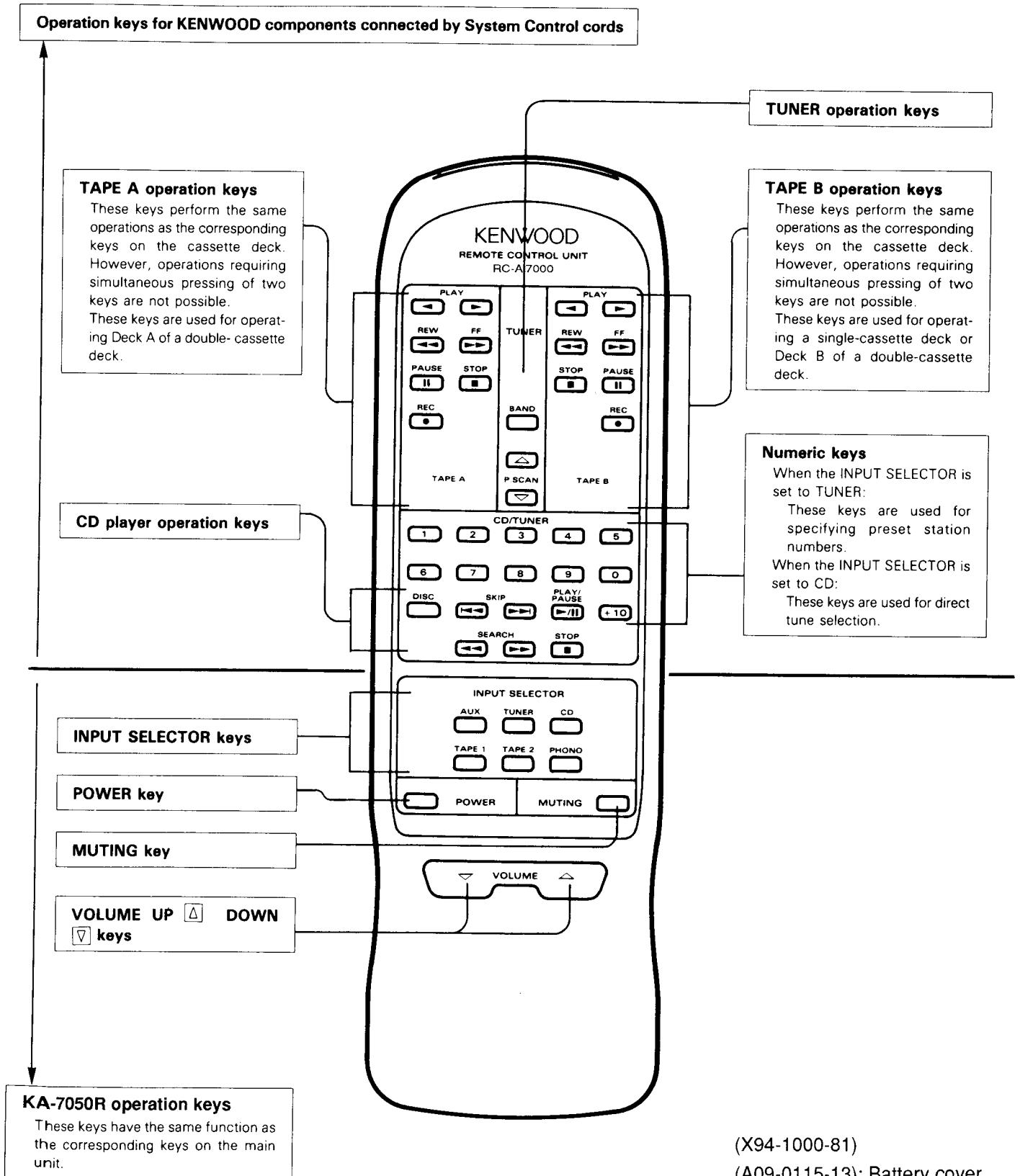

(X94-1000-81)

(A09-0115-13): Battery cover

KA-7050R

SPECIFICATIONS

Rated Power Output

100 watts per channel minimum RMS, both channels driven, at 8Ω from 20 Hz to 20,000 Hz with no more than 0.008% total harmonic distortion.

Maximum Continuous Power Output (DIN)

1 kHz at 4Ω 175W

Maximum Continuous Power Output (DIN)

1 kHz at 8Ω 115W

Maximum Continuous Power Output (IEC/NF)

from 63 Hz to 12,500 Hz, 0.7% Total Harmonic

Distortion at 8Ω 115W + 115W

Dynamic Power 360W per channel at 2Ω

260W per channel at 4Ω

150W per channel at 8Ω

Total Harmonic Distortion

(LINE input to SPEAKER output)

Rated Output Power at 8Ω.

20 Hz to 20,000 Hz 0.008%

Frequency Response

LINE (CD) 5 Hz to 100 kHz +0 dB, -3 dB

PHONO "RIAA" Response

PHONO (MM) Input 20 Hz to 20 kHz ±0.3 dB

PHONO (MC) Input 20 Hz to 20 kHz ±0.3 dB

Signal To Noise Ratio

PHONO (MM) (IHF '66) 87 dB

PHONO (MC) (IHF '66) 69 dB

LINE (CD) (IHF '66) 102 dB

PHONO (MM) (IHF '78) 86 dB

PHONO (MC) (IHF '78) 75 dB

LINE (CD) (IHF '78) 96 dB

PHONO (MM) at Unweighted.

50 mW Output (DIN) 68 dB

TUNER/AUX/TAPE/CD at Unweighted.

50 mW Output (DIN) 70 dB

Filter SUBSONIC 18 Hz -18 dB/oct

Tone Control

BASS ±10 dB at 100 Hz

TREBLE ±10 dB at 10 kHz

Loudness Control +6 dB at 100 Hz, +3 dB at 10 kHz

Damping Factor 250/50 Hz

Input Sensitivity/Impedance

PHONO (MM) 2.5 mV 47 kΩ

PHONO (MC) 0.2 mV 100Ω

LINE (TUNER/AUX/TAPE/CD) 200 mV 47 kΩ

Phono Maximum Input Level

MM at 1 kHz 0.08% T.H.D. 120 mV

MC at 1 kHz 0.08% T.H.D. 10 mV

Output Level/Impedance

TAPE REC (Pin) 200 mV 220Ω

General

Power Consumption

3.8A U.S.A. & Canada Model

350W IEC

Dimensions W: 440 mm

H: 163 mm

D: 403 mm

Weight (net) 15.4 kg

Note:

KENWOOD follows a policy of continuous advancements in development. For this reason specifications may be changed without notice.

Note:

Component and circuitry are subject to modification to insure best operation under differing local conditions. This manual is based on the Europe (E) standard, and provides information on regional circuit modification through use of alternate schematic diagrams, and information on regional component variations through use of parts list.

KENWOOD CORPORATION

Alive Mitake, 2-5, Shibuya 1-chome, Shibuya-ku, Tokyo 150, Japan

KENWOOD U.S.A. CORPORATION

COMMUNICATIONS & TEST EQUIPMENT GROUP
P.O. BOX 22745, 2201 East Dominguez St., Long Beach, CA 90801-5745, U.S.A.

KENWOOD ELECTRONICS DEUTSCHLAND GMBH

Rembrücker Str. 15, 6056 Heusenstamm, Germany

KENWOOD ELECTRONICS BENELUX N.V.

Mechelsesteenweg 418 B-1930 Zaventem, Belgium

TRIO-KENWOOD FRANCE S.A.

13, Boulevard Ney, 75018 Paris, France

TRIO-KENWOOD U.K. LIMITED

KENWOOD House, Dwight Road, Watford, Herts., WD1 8EB United Kingdom

KENWOOD ELECTRONICS NEDERLAND B.V.

Amsterdamseweg 35, 1422 AC Uithoorn, The Netherlands

KENWOOD LINEAR S.p.A.

20125, Milano-Via Arbe, 50, Italy

KENWOOD ESPAÑA S.A.

Bolivia, 239-08020 Barcelona, Spain

KENWOOD ELECTRONICS AUSTRALIA PTY. LTD.

(A.C.N. 001 499 074)

P.O. BOX 504, 8 Figtree Drive, Australia Centre, Homebush, N.S.W. 2140, Australia

KENWOOD & LEE ELECTRONICS, LTD.

Unit 3712-3724, Level 37, Tower one Metroplaza, 223 Hing Fong Road, Kwai Fong, N.T., Hong Kong

KENWOOD ELECTRONICS CANADA INC.

6070 Kestrel Road, Mississauga, Ontario, Canada L5T 1S8