

A MECHA ASS'Y
 D40-1267-06 (M, X) (X-87) D40-1280-05 (T, E) (X-87)
 D40-1267-05 (M, X) (X-87) D40-1267-06 (M, X, T, E) (X-57)

X28-2550-01 (M, X) (X-97) (JAPAN MADE)
 X28-2550-06 (X, T, E) (X-87) (SINGAPORE MADE)

X28-2550-03 (M,
 X28-2550-08 (M)

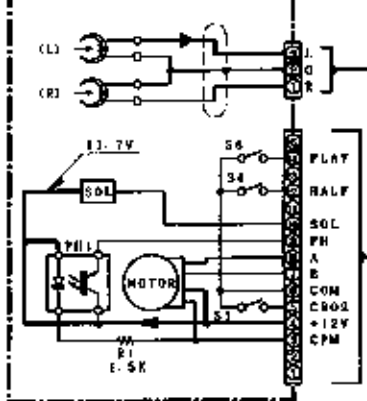

PH1 : NJM5106K
 B MECHA ASS'Y
 D40-1260-06 (M, X) (X-87)
 D40-1258-05 (M, X) (X-87)
 D40-1261-06 (T, E) (X-87)
 D40-1260-06 (M, X, T, E) (X-57)

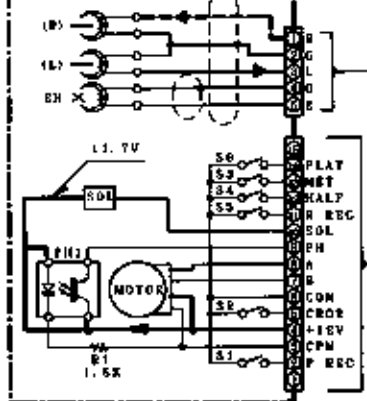

PH1 : NJM5165X
 IC1 : MS0845-1525P
 IC2 : HA12157N
 IC3 : MSMS887I
 IC5 : XR04052R or TC4052RP
 IC6, 7 : TA812ES
 IC8-10 : RC4585D or NJM4585D
 IC11, 12 : XRA1088R
 IC18 : DA15218-DX or RC4585D-D or NJM4585D-D

Q1 : 2SB1870
 Q2 : 2SD2081
 Q3, 10 : 2SA200 (E, F)
 Q4-8 : 2SC3940A
 Q11-13, 20 : 2SA100A (Q, R) or 2SA1048 (Y, GR)
 Q14-18 : 2SC3911A (Q, R) or 21-27, 47, 48 3SC2458 (Y, GR)
 Q28-31 : UN4112 or DTA124ES
 Q19, 32-38 : UN4213 or DTC124ES
 42-46, 48-58
 D1-11, 89 : 56888B or JSR159-100 84, 87
 D12, 18 : 3B7210
 D14-16 : RD2, 7ES (B2) or HZ52, 7N (B2)
 D17 : RD3, 8ES (B8) or HZ53, 3N (B2)
 D18, 19 : RD4, 7ES (B) or HZ54, 7N (B)
 D108 : RD5, 9ES (B2) or HZ56, 6N (B2)
 D20 : RD6, 2ES (B2) or HZ56, 2N (B2)
 D21 : RD8, 2ES (B3) or HZ56, 2N (B2)
 D22 : RD24ES (D) or HZ584N (B)
 D23 : RD3DES (B) or HZ590N (B)
 D24-62 : 1S3199 or HSS104
 65-88 :
 89-102 :
 L9 : L32-0888-05
 ED1 : FIP9CM8R

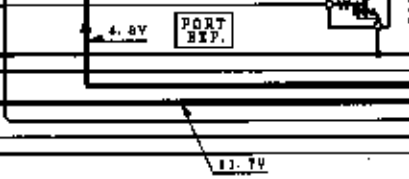
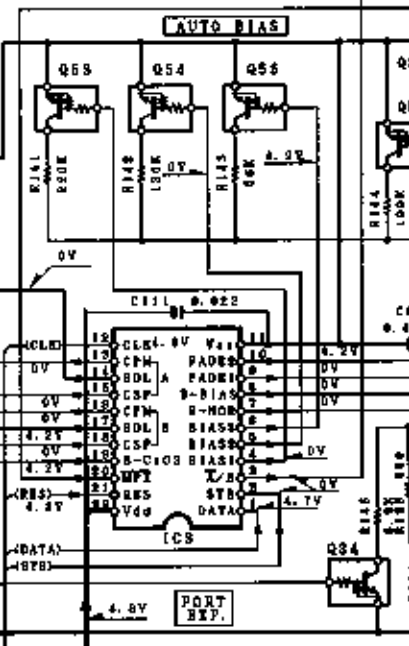
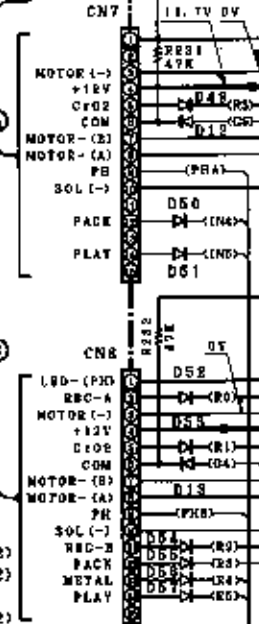
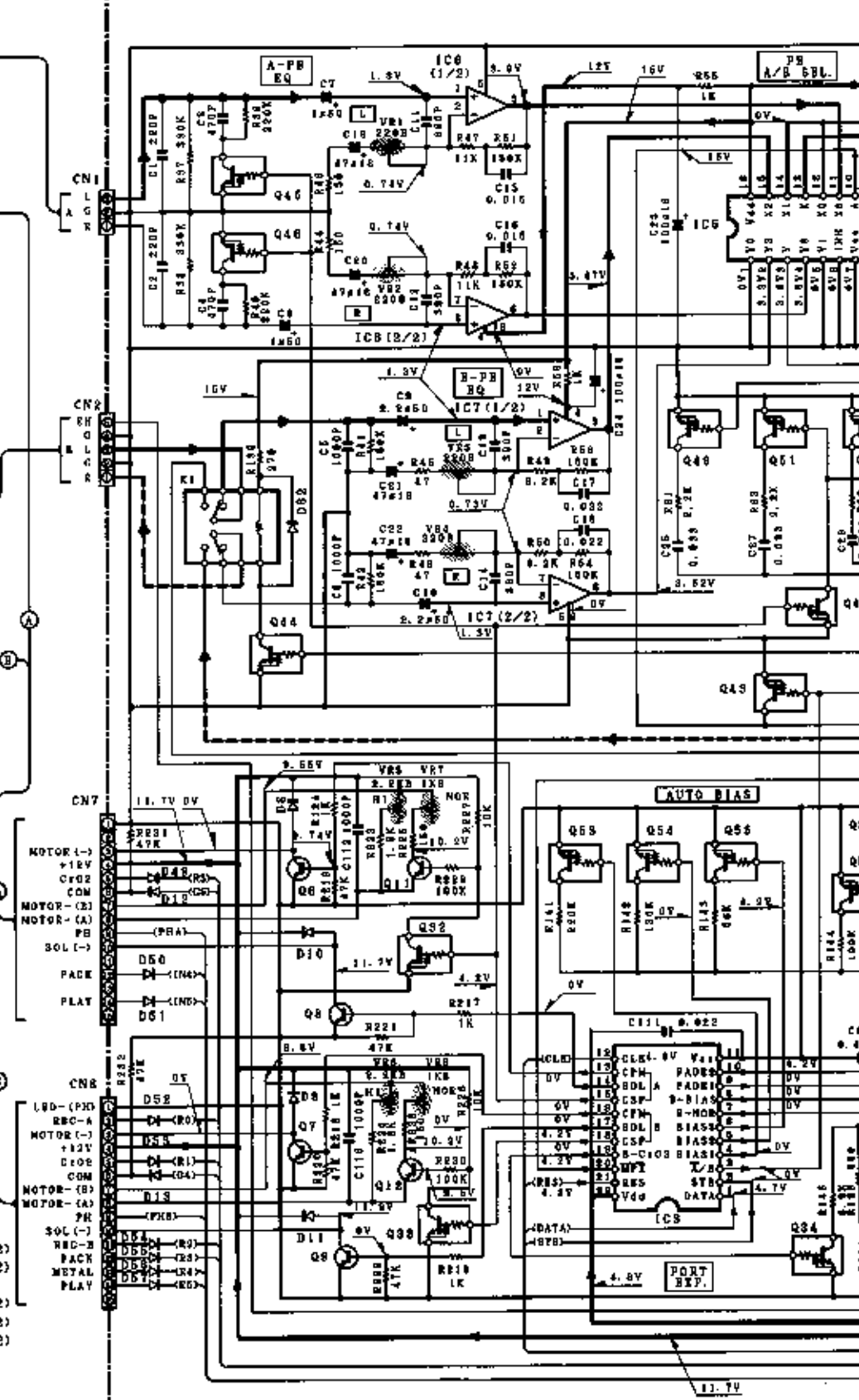

(M, X, T, E) (X-87) (JAPAN MADE)
 (M) (X-87) (SINGAPORE MADE)

X28-2550-04 (M, X, T, E) (X-57) (JAPAN MADE)
 X28-2550-07 (M, X, T, E) (X-57) (SINGAPORE)

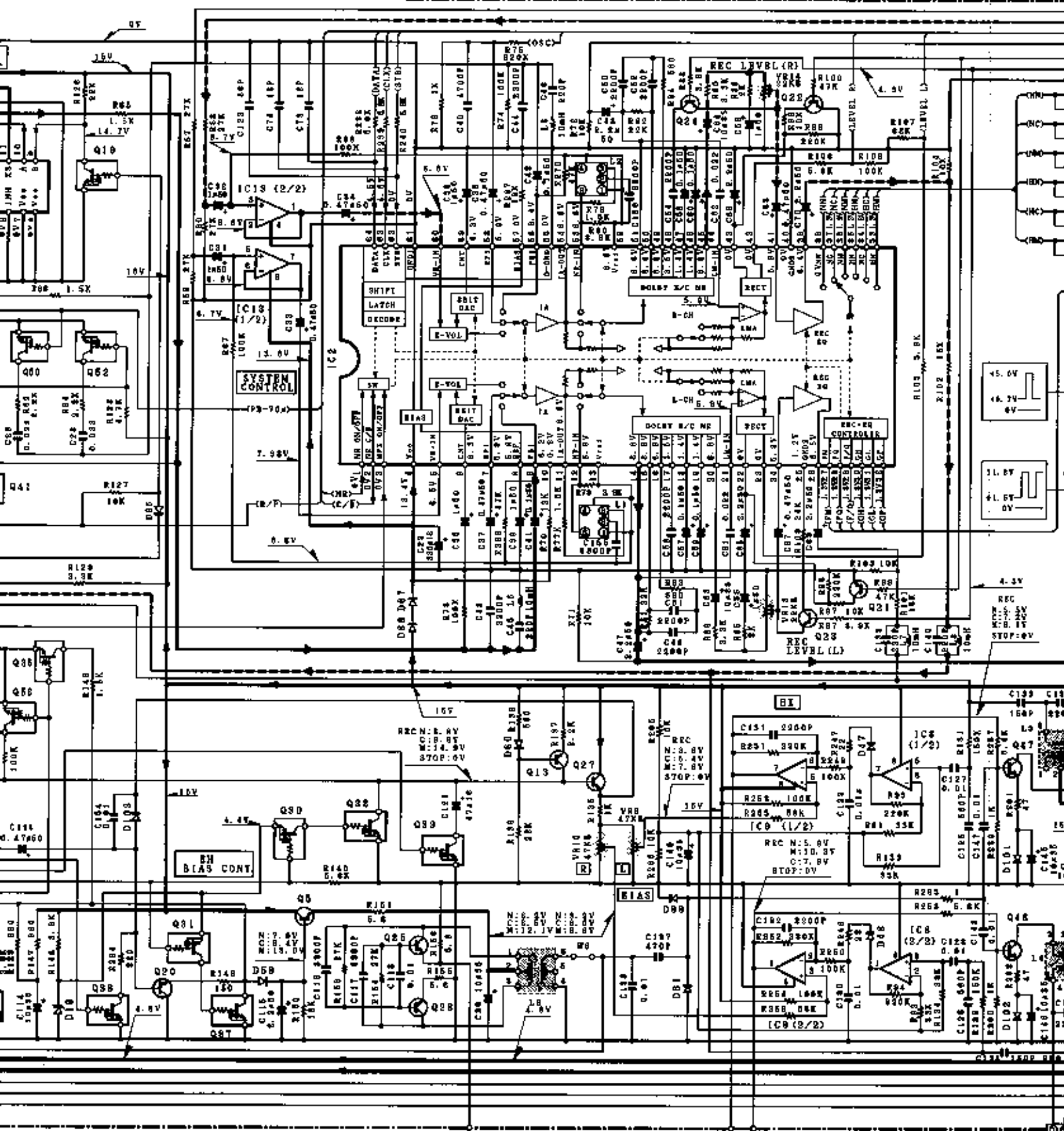

BIAS FREQ.
 (100KHz)

(L-CH)(R-CH)
 BOTTOM VOLTAGE A01.

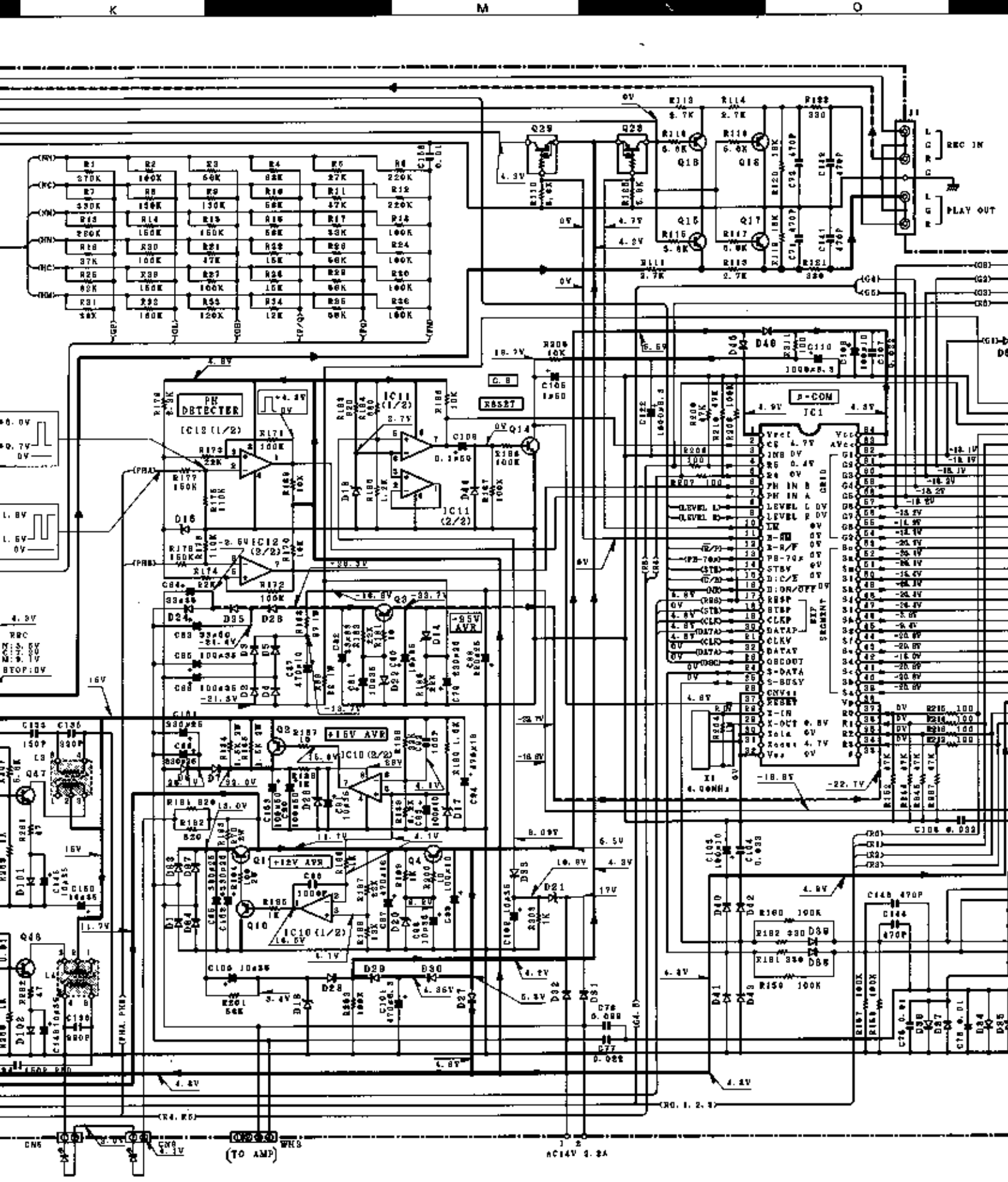

Die angegebenen Gleichspannungswerte wurden bei eingesetzter Cassette in der Wiedergabe mit einem hochohmigen Spannungsmesser gemessen. Dabei schwanken die Meßwerte aufgrund von Unterschieden zwischen einzelnen Instrumenten oder Geräten u. U. geringfügig. Die angegebenen Gleichspannungswerte der Vormagnetsierungsschaltung wurden in der Aufnahme-Betriebsart gemessen.

Les tensions c.c. doivent être mesurées avec un voltmètre à haute impédance, une cassette étant insérée en mode de lecture. Les valeurs peuvent différer légèrement du fait des variations inhérentes aux appareils et aux instruments de mesure individuels. Les tensions c.c. du circuit de polarité doivent être mesurées, l'appareil étant en mode d'enregistrement.

DC voltages are to be measured with a high impedance voltmeter, a cassette tape being inserted in playback mode. The values may vary slightly due to variations between individual instruments and devices. The DC voltages of the polarity circuit should be measured, the device being in recording mode.

X28-255X-XX (B/4)

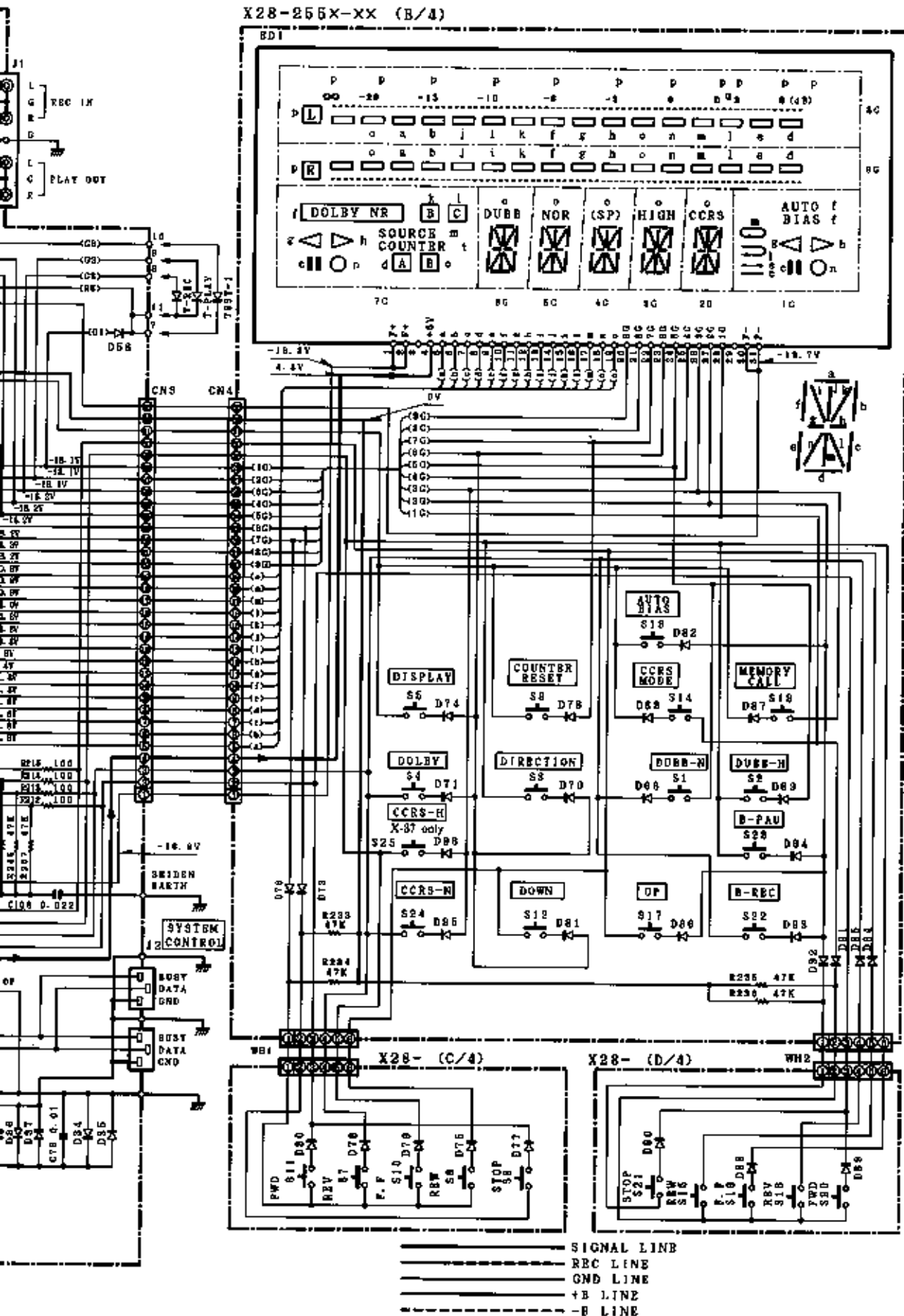

2SA999
2SC3940A



2SA1175
2SC2785

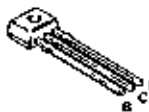

DTA124ES
DTC124ES
UN4112
2SA1048
2SA933S
2SC1740S
2SC2458



2SB1370
2SD2061



UN4212
2SA1309A
2SC3311A

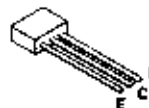

MSM59371

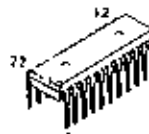

— SIGNAL LINE
- - - REC LINE
... GND LINE
- · - · +B LINE
- - - -B LINE

CAUTION: For continued safety, replace safety critical components only with manufacturer's recommended parts (refer to parts list). **⚠** Indicates safety critical components. To reduce the risk of electric shock, leakage-current or resistance measurements shall be carried out (exposed parts are acceptably insulated from the supply circuit) before the appliance is returned to the customer.

Y26-3700-21

X-57
KEN

DC voltages are as measured with a high impedance voltmeter with a cassette loaded at playback mode. Values may vary slightly due to variations between individual instruments and units. Bias circuit DC voltages are as measured while in the record mode.

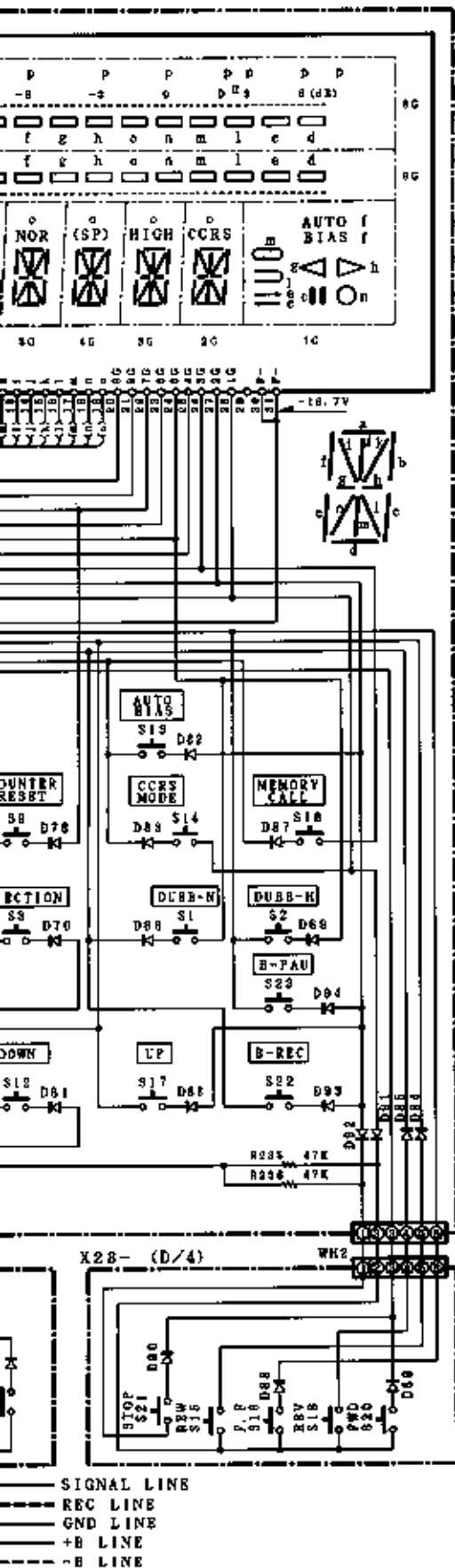

2SA999
2SC3940A

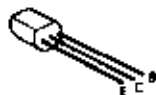

2SA1175
2SC2785

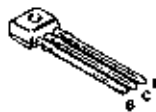

DTA124ES
DTC124ES
UN4112
2SA1048
2SA933S
2SC1740S
2SC2458

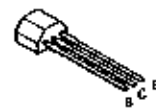

2SB1370
2SD2061



UN4212
2SA1309A
2SC3311A

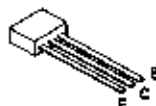

MSM59371

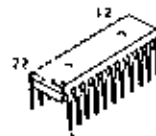

NJM4565D
NJM4565D-D



XRU4052B

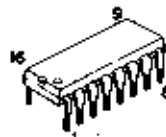

TC4052BP

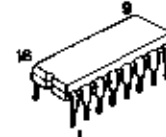

TA8125S

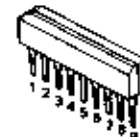

XRA10393

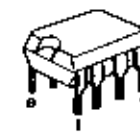

M50945-152SP

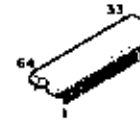

HA12157NT

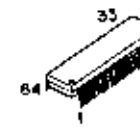

CAUTION: For continued safety, replace safety critical components only with manufacturer's recommended parts (refer to parts list). Δ indicates safety critical components. To minimize the risk of electric shock, leakage current or resistance measurements shall be carried out (exposed parts are acceptably insulated from the supply circuit) before the appliance is returned to the customer.

Y26-3700-21

X-57/87/97
KENWOOD

EXPLODED VIEW (MECHANISM UNIT)

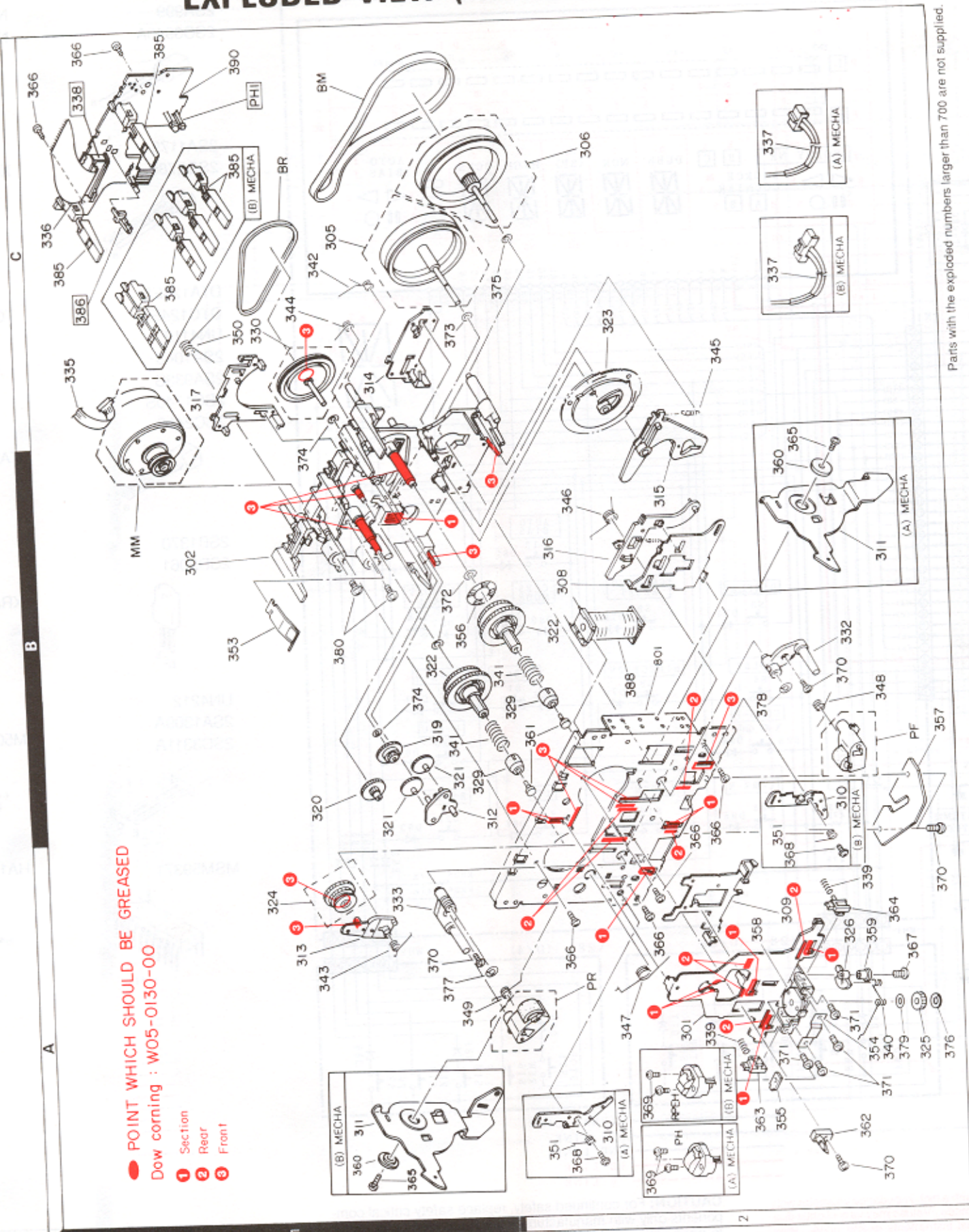

● POINT WHICH SHOULD BE GREASED
 Dow corning : W05-0130-00

- 1 Section
- 2 Rear
- 3 Front

Parts with the exploded numbers larger than 700 are not supplied.

EXPLODED VIEW (UNIT)

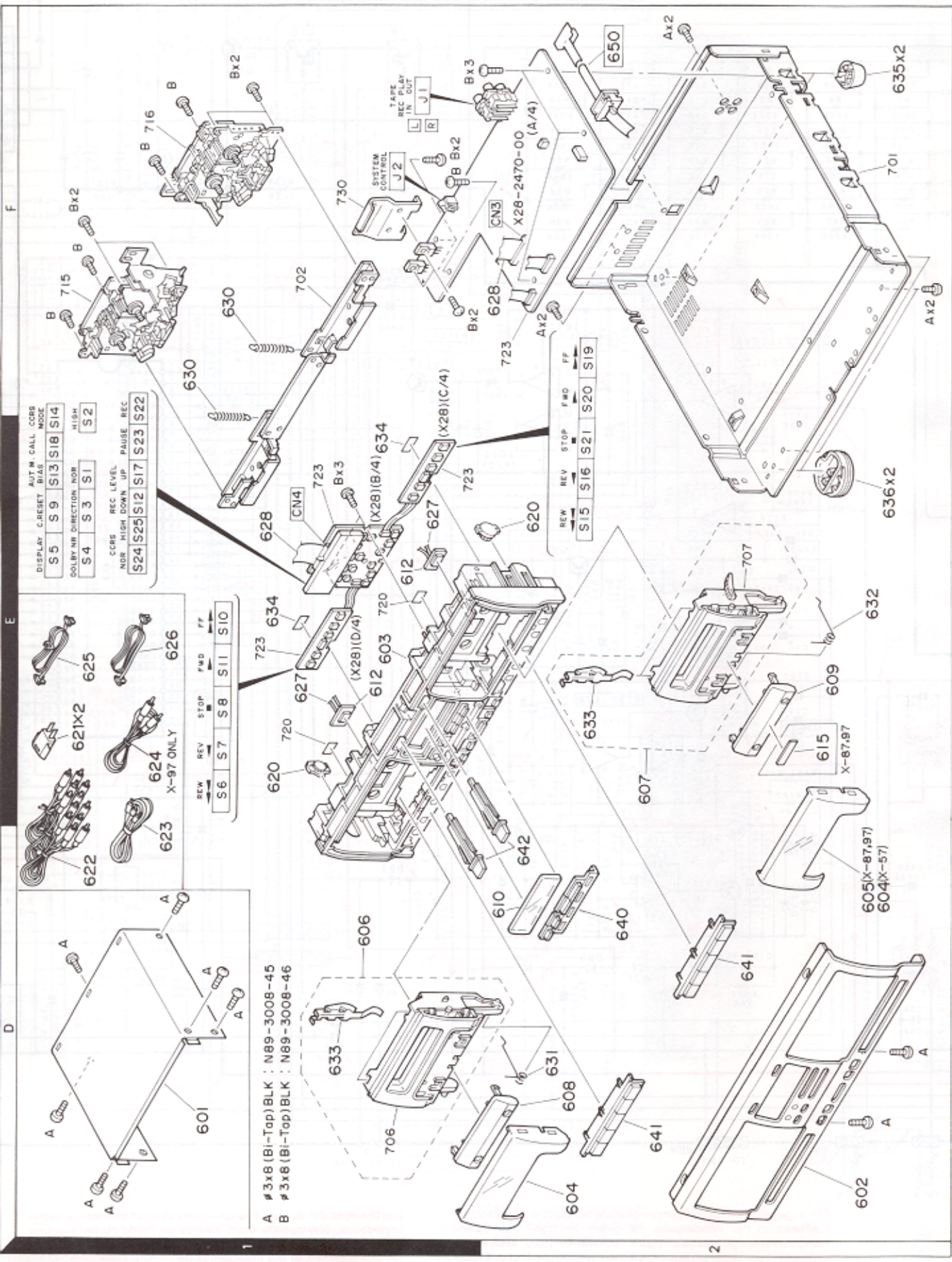

Parts with the exploded numbers larger than 700 are not supplied.

PARTS LIST

No.2

* New Parts
Parts without Parts No. are not supplied.
Les articles non mentionnés dans le Parts No. ne sont pas fournis.
Teile ohne Parts No. werden nicht geliefert.

Ref. No. 参照番号	Address 位置	Parts No. 部品番号	Description 部品名 / 規格	Desti- nation 仕
606	1D	A53-1378-03	CASSETTE HOLDER ASSY	A
607	2E	A53-1380-03	CASSETTE HOLDER ASSY	B
608	2D	807-2210-03	ESCUTCHEON	A
609	2E	807-2211-03	ESCUTCHEON	B
610	2D	810-1929-04	FRONT GLASS	A
612	1E	830-0740-05	LED(SUB-201C) TAPE BACK LIGHT	B
615	2E	843-0297-04	BADGE	A
-	-	846-0096-33	WARRANTY CARD	X
-	-	846-0310-03	WARRANTY CARD	TE
620	1E, 2E	039-0176-05	DAMPER	M
622	1E	E03-0115-05	AC PLUG ADAPTER	M
623	1E	E30-0505-05	AUDIO CORD	A
624	1D	E30-0615-05	AUDIO CORD	B
625	1E	E30-2627-05	CORD WITH CONNECTOR	A
626	1E	E30-2628-05	CORD WITH CONNECTOR	B
627	1E	E31-4860-05	WIRING HARNESS LED LEAD WIRE	J
628	1E, 2F	E35-0165-05	FLAT CABLE CN3-CN4	M
630	1F	G01-3405-04	EXTENSION SPRING	S
631	2D	G01-3406-04	TORSION COIL SPRING	S
632	2E	G01-3407-04	TORSION COIL SPRING	S
633	1D, 2E	G02-0944-04	FLAT SPRING	S
634	1E	G11-0155-14	SOFT TAPE	S
-	-	H10-5334-02	POLYSTYRENE FOAMED FIXTURE L	J
-	-	H10-5335-02	POLYSTYRENE FOAMED FIXTURE R	J
-	-	H10-5589-02	POLYSTYRENE FOAMED FIXTURE L	J
-	-	H10-5590-02	POLYSTYRENE FOAMED FIXTURE R	J
-	-	H20-0564-04	PROTECTION COVER	M
-	-	H25-0232-04	PROTECTION BAG (235X350X0.03)	MX
-	-	H25-0304-04	PROTECTION BAG (0232 PRINTED)	EX
-	-	H25-0451-04	PROTECTION BAG (0232 PRINTED)	EX
-	-	H25-0456-04	PROTECTION BAG (0304 PRINTED)	T
-	-	H50-0768-04	ITEM CARTON CASE	J
-	-	H50-0784-04	ITEM CARTON CASE	M
-	-	H50-0785-04	ITEM CARTON CASE	X
-	-	H50-0807-04	ITEM CARTON CASE	TE
635	2E	J02-0366-15	FOOT	J
636	2E	J02-1040-05	FOOT	J
640	2D	K29-4431-04	KN08 SELECTOR	S
641	2D	K29-4432-03	KN08 MECHANISM CONTROL	S
642	2D	K29-4433-04	KN08 EJECT	S
A	1D, 2F	N89-3008-45	BINDING HEAD TAPTITE SCREW	J

X-97 (UNIT)
METALLIC CABINET
PANEL
SUB PANEL
CASSETTE LID
CASSETTE LID
CASSETTE LID
CASSETTE HOLDER ASSY
CASSETTE HOLDER ASSY
ESCUTCHEON
CASSETTE HOLDER

L:Scandinavia
Y:PAF(East, Hawaii)
Y:AFES(Europe)

K:USA
T:England
X:Australia
M:Other Areas

J: Japan made
S: Singapore made
A: A DECK
B: B DECK

△ indicates safety critical components

No.1

* New Parts
Parts without Parts No. are not supplied.
Les articles non mentionnés dans le Parts No. ne sont pas fournis.
Teile ohne Parts No. werden nicht geliefert.

Ref. No. 参照番号	Address 位置	Parts No. 部品番号	Description 部品名 / 規格	Desti- nation 仕
601	1D	A01-1905-21	METALLIC CABINET	A
602	2D	A60-0484-02	PANEL	B
603	1E	A22-1570-01	SUB PANEL	A
604	2D	A53-1376-03	CASSETTE LID	B
606	1D	A53-1378-03	CASSETTE HOLDER ASSY	A
607	2E	A53-1380-03	CASSETTE HOLDER ASSY	B
608	2D	807-2210-03	ESCUTCHEON	A
609	2E	807-2211-03	ESCUTCHEON	B
610	2D	810-1929-04	FRONT GLASS	A
612	1E	807-1720-04	WARRANTY CARD	X
-	-	846-0096-33	WARRANTY CARD	TE
-	-	846-0310-03	WARRANTY CARD	M
620	1E, 2E	039-0176-05	DAMPER	M
622	1E	E03-0115-05	AC PLUG ADAPTER	M
623	1E	E30-0505-05	AUDIO CORD	A
624	1E	E30-0615-05	AUDIO CORD	B
625	1E	E30-2627-05	CORD WITH CONNECTOR	A
626	1E	E30-2628-05	CORD WITH CONNECTOR	B
628	1E, 2F	E35-0165-05	FLAT CABLE CN3-CN4	M
630	1F	G01-3405-04	EXTENSION SPRING	S
631	2D	G01-3406-04	TORSION COIL SPRING	S
632	2E	G01-3407-04	TORSION COIL SPRING	S
633	1D, 2E	G02-0944-04	FLAT SPRING	S
634	1E	G11-0155-14	SOFT TAPE	S
-	-	H10-5334-02	POLYSTYRENE FOAMED FIXTURE L	J
-	-	H10-5335-02	POLYSTYRENE FOAMED FIXTURE R	J
-	-	H10-5889-02	POLYSTYRENE FOAMED FIXTURE L	J
-	-	H10-5590-02	POLYSTYRENE FOAMED FIXTURE R	J
-	-	H20-0564-04	PROTECTION COVER	M
-	-	H25-0232-04	PROTECTION BAG (235X350X0.03)	MX
-	-	H25-0304-04	PROTECTION BAG (0232 PRINTED)	XE
-	-	H25-0451-04	PROTECTION BAG (0232 PRINTED)	T
-	-	H25-0456-04	PROTECTION BAG (0304 PRINTED)	T
-	-	H50-0770-04	ITEM CARTON CASE	J
-	-	H50-0821-04	ITEM CARTON CASE	M
-	-	H50-0822-04	ITEM CARTON CASE	V
-	-	H50-0854-04	ITEM CARTON CASE	TE
635	2E	J02-0366-15	FOOT	J
636	2E	J02-1040-05	FOOT	J
640	2D	K29-4431-04	KN08 SELECTOR	S
641	2D	K29-4432-03	KN08 MECHANISM CONTROL	S
642	2D	K29-4433-04	KN08 EJECT	S
A	1D, 2F	N89-3008-45	BINDING HEAD TAPTITE SCREW	J

X-87 (UNIT)
METALLIC CABINET
PANEL
SUB PANEL
CASSETTE LID
CASSETTE LID

L:Scandinavia
Y:PAF(East, Hawaii)
Y:AFES(Europe)

K:USA
T:England
X:Australia
M:Other Areas

J: Japan made
S: Singapore made
A: A DECK
B: B DECK

△ indicates safety critical components

PARTS LIST

No.4

K New Parts
Parts without Parts No. are not supplied.
Les articles non mentionnés dans le Parts No. ne sont pas fournis.
Teile ohne Parts No. werden nicht geliefert.

Ref. No. 参照番号	Address 位置	Parts No. 部品番号	Description 部品名 / 規格	Desti- nation 向	Re- marks 備考
C29		CE04KW1C33JM	ELECTR0	J	
C29		CE04LM1C33JM	ELECTR0	J	
C30		CE04KM1V100M	ELECTR0	J	
C30		CE04LM1V100M	ELECTR0	J	
C31	.32	CE04KW1H010M	ELECTR0	J	
C31	.32	CE04KW1H010M	ELECTR0	J	
C33	.34	CE04KW1HR47M	ELECTR0	J	
C33	.34	CE04KW1HR47M	ELECTR0	J	
C33	.34	CE04KW1HR47M	ELECTR0	J	
C35	.36	CE04KW1H010M	ELECTR0	J	
C35	.36	CE04KW1H010M	ELECTR0	J	
C37	.38	CE04KW1H010M	ELECTR0	J	
C37	.38	CE04KW1HR47M	ELECTR0	J	
C39		CE04KW1H010M	ELECTR0	J	
C39		CE04KW1H010M	ELECTR0	J	
C40		CK45FSLH472Z	CERAMIC	J	
C41	.42	CE04KW1H010M	ELECTR0	J	
C41	.42	CE04LM1H010M	ELECTR0	J	
C43	.44	CK45FSLH222K	CERAMIC	J	
C45	.46	CC45FSLH221J	CERAMIC	J	
C47	.48	CE04KW1H2R2M	ELECTR0	J	
C47	.48	CE04LM1H2R2M	ELECTR0	J	
C49	.54	C092FMIH22J	MYLAR	J	
C55	.56	CE04KW1H010M	ELECTR0	J	
C55	.56	CE04LM1H010M	ELECTR0	J	
C57	.60	CE04KW1H010M	ELECTR0	J	
C57	.60	CE04LM1H010M	ELECTR0	J	
C61	.62	CE04KW1V100M	ELECTR0	J	
C63	.64	CE04KW1V100M	ELECTR0	J	
C63	.64	CE04LM1V100M	ELECTR0	J	
C65	.66	CE04KW1H2R2M	ELECTR0	J	
C65	.66	CE04LM1H2R2M	ELECTR0	J	
C67	.68	CE04KW1HR47M	ELECTR0	J	
C67	.68	CE04LM1HR47M	ELECTR0	J	
C69	.70	CE04KW1H2R2M	ELECTR0	J	
C69	.70	CE04LM1H2R2M	ELECTR0	J	
C71	.72	CK45EB1H471K	CERAMIC	J	
C71	.72	CK45EB1H471K	CERAMIC	J	
C73	.74	CC45FSLH180J	CERAMIC	J	
C76	.78	CK45FSLH103Z	CERAMIC	J	
C76	.78	CK45FSLH229Z	CERAMIC	J	
C78		CE04KW1E221M	ELECTR0	J	
C78		CE04LM1E221M	ELECTR0	J	
C80	.81	CE04KW1V100M	ELECTR0	J	
C80	.81	CE04LM1V100M	ELECTR0	J	
C82		CE04KW1J330M	ELECTR0	J	
C82		CE04LM1J330M	ELECTR0	J	
C83		CE04KW1H330M	ELECTR0	J	
C83		CE04LM1H330M	ELECTR0	J	
C84		CE04KW1V330M	ELECTR0	J	
C84		CE04LM1V330M	ELECTR0	J	
C85	.86	CE04KW1V101M	ELECTR0	J	
C85	.86	CE04LM1V101M	ELECTR0	J	
C87		CE04KW1A471M	ELECTR0	J	

L:Scandinavia
Y:PA(Far East, Hawaii)
Y:AMFES(Europe)
KUSA
T:England
X:Australia
P:Canada
E:Europe
M:Other Areas
J: Japan made
S: Singapore made
5: X-57
8: X-87
9: X-97
Δ indicates safety critical components

No.3

K New Parts
Parts without Parts No. are not supplied.
Les articles non mentionnés dans le Parts No. ne sont pas fournis.
Teile ohne Parts No. werden nicht geliefert.

Ref. No. 参照番号	Address 位置	Parts No. 部品番号	Description 部品名 / 規格	Desti- nation 向	Re- marks 備考
609	2E	B07-2211-03	ESCUTCHEON		B
610	2D	B10-1929-04	FRONT GLASS		
612	1E	B30-0710-05	LEDS(LF-201C) TAPE BACK LIGHT		
615	2E	B43-0237-04	RANGE	X	
-		B46-0096-33	WARRANTY CARD		
-		B46-0310-03	WARRANTY CARD		
620	1E, 2E	039-0176-05	DAMPER		
621	1E	E03-0115-05	AC PLUG ADAPTER		
622	1E	E30-0505-05	AUDIO CORD	M	
623	1D	E30-0415-05	AUDIO CORD		
624	1D	E30-1427-05	AUDIO CORD		
625	1E	E30-2627-05	CORD WITH CONNECTOR		
626	1E	E30-2628-05	CORD WITH CONNECTOR		
627	1E	E31-4860-05	WIRING HARNESS LED LEAD WIRE		
628	1E, 2F	E35-0165-05	FLAT CABLE CN3-CN4		
630	1F	G01-3405-04	EXTENSION SPRING		
631	2D	G01-3406-04	TORSION COIL SPRING		
632	2E	G01-3407-04	TORSION COIL SPRING	A	
633	1D, 2E	G02-0944-04	TORSION COIL SPRING	B	
634	1E	G10-0146-04	FLAT SPRING		
-		H10-5334-02	NON-WOVEN FABRIC		
-		H10-5335-02	POLYSTYRENE FRAMED FIXTURE L		
-		H20-0564-04	POLYSTYRENE FRAMED FIXTURE R		
-		H25-0232-04	PROTECTION COVER	M	
-		H25-0304-04	PROTECTION BAG (235X350X0.03)		
-		H50-0767-04	PROTECTION BAG	X	
635	2F	J02-0366-15	ITEM CARTON CASE		
636	2E	J02-1040-05	FOOT		
640	2D	K29-4431-04	REAR		
641	2D	K29-4432-03	FRONT		
642	2D	K29-4433-04	KN08 SELECTOR		
A	1D, 2F	M89-3008-45	KN08 MECHANISM CONTROL		
			KN08 EJECT		
RECORD/PLAYBACK AMPLIFIER UNIT (X28-2550-XX)					
C1	.2	CC45FSLH221J	BINDING HEAD TAPPIE SCREW		
C3	.4	CK45EB1H471K	CERAMIC	J	
C5	.6	CK45EB1H102K	CERAMIC	K	
C5	.6	CK45EB1H102K	CERAMIC	K	
C5	.6	CK45FSLH561K	CERAMIC	K	
C7	.8	CE04KW1H010M	ELECTR0	9	
C7	.8	CE04LM1H010M	ELECTR0	5	
C9	.10	CE04KW1H2R2M	ELECTR0	J	
C9	.10	CE04LM1H2R2M	ELECTR0	J	
C11	.14	CK45FSLH391K	CERAMIC	J	
C15	.16	C092FMIH53J	MYLAR	S	
C17	.18	C092FMIH223J	MYLAR	J	
C19	.22	CE04KW1C470M	ELECTR0	J	
C19	.22	CE04LM1C470M	ELECTR0	J	
C23	.24	CE04KW1C101M	ELECTR0	J	
C23	.24	CE04LM1C101M	ELECTR0	J	
C25	.26	CF92FMIH333J	MF	S	
C27	.28	CK45FSLH333Z	CERAMIC	S	

L:Scandinavia
Y:PA(Far East, Hawaii)
Y:AMFES(Europe)
KUSA
T:England
X:Australia
P:Canada
E:Europe
M:Other Areas
J: Japan made
S: Singapore made
A: A DECK
B: B DECK
5: X-57
8: X-87
9: X-97
Δ indicates safety critical components

PARTS LIST

No.6

* New Parts
Parts without Parts No. are not supplied.
Les articles non mentionnés dans le Parts No. ne sont pas fournis.
Teile ohne Parts No. werden nicht geliefert.

Ref. No. 参照番号	Address 位置	Parts No. 部品番号	Description 部品名/規格	Desti- nation 仕向	Re- marks 備考
C122		CE04DWJ102M	ELECTRØ 1000UF 6.3WV	J	
C123		CE04EVOJ102M	ELECTRØ 1000UF 6.3WV	S	
C124		CC45FSL1H560J	CERAMIC 56PF J	J	
C125		CE04AKM1HOR1M	ELECTRØ 0.1UF 50WV	J	
C126		CE04ALM1HOR1M	ELECTRØ 0.1UF 50WV	S	
C127		CK45EB1H561K	CERAMIC 56DPF K	9	
C128		CK45EB1H561K	CERAMIC 56DPF K	8	
C129		CK45EF1H103Z	CERAMIC 0.010UF Z	9	
C130		CK45FF1H103Z	CERAMIC 0.010UF Z	8	
C131		CB92FM1H222J	NYLAR 2200PF J	9	
C132		CB92FM1H222J	NYLAR 2200PF J	8	
C133		C91-1434-05	FILM 150PF J	9	
C134		C91-1434-05	FILM 150PF J	8	
C135		C91-1436-05	FILM 220PF J	9	
C136		C91-1436-05	FILM 220PF J	8	
C137		CK45FB2H471K	CERAMIC 470PF K	9	
C138		CK45FB2H471K	CERAMIC 470PF K	8	
C139		CB93HP2A103J	MYLAR 0.010UF J	9	
C140		CB93HP2A103J	MYLAR 0.010UF J	8	
C141		CC45FSL1H221J	CERAMIC 220PF J	9	
C142		CK45FB1H471K	CERAMIC 470PF K	9	
C143		CE04AKM1V100M	ELECTRØ 10UF 35WV	J	
C144		CE04AKM1V100M	ELECTRØ 10UF 35WV	8	
C145		CE04ALM1V100M	ELECTRØ 10UF 35WV	J	
C146		CE04ALM1V100M	ELECTRØ 10UF 35WV	8	
C147		CK45FF1H103Z	CERAMIC 0.010UF Z	9	
C148		CK45FF1H103Z	CERAMIC 0.010UF Z	8	
C149		CE04AKM1V100M	ELECTRØ 10UF 35WV	J	
C150		CE04AKM1V100M	ELECTRØ 10UF 35WV	8	
C151		CE04ALM1V100M	ELECTRØ 10UF 35WV	J	
C152		CE04ALM1V100M	ELECTRØ 10UF 35WV	8	
C153		CE04DW1E331M	ELECTRØ 330UF 25WV	J	
C154		CE04DW1E331M	ELECTRØ 330UF 25WV	8	
C155		CE04EVM1E331M	ELECTRØ 330UF 25WV	J	
C156		CE04EVM1E331M	ELECTRØ 330UF 25WV	8	
C157		CE04AKM1H101M	ELECTRØ 1000UF 50WV	J	
C158		CE04AKM1H101M	ELECTRØ 1000UF 50WV	8	
C159		CK45FF1H103Z	CERAMIC 0.010UF Z	9	
C160		CK45FF1H103Z	CERAMIC 0.022UF Z	9	
C161		E30-2584-05	C68D WITH CONNECTOR	J	
C162		E30-4173-05	FLAT CABLE CONNECTOR	J	
C163		E30-4213-05	FLAT CABLE CONNECTOR	J	
C164		E13-0446-05	PHONO JACK	J	
C165		E06-0312-05	RECTANGULAR RECEPTACLE SYNCHRO	J	
C166		L79-1201-05	LC FILTER	J	
C167		L32-0547-05	BIAS OSCILLATING COIL	9	
C168		L32-0547-05	BIAS OSCILLATING COIL	8	
C169		L40-1035-29	SMALL FIXED INDUCTOR<10MH, J>	9	
C170		L40-1035-29	SMALL FIXED INDUCTOR<10MH, J>	8	
C171		L40-1035-29	SMALL FIXED INDUCTOR<10MH, J>	9	
C172		L40-1035-29	SMALL FIXED INDUCTOR<10MH, J>	8	
C173		L32-0368-05	BIAS OSCILLATING COIL	9	
C174		L32-0368-05	BIAS OSCILLATING COIL	8	
C175		L40-1035-29	SMALL FIXED INDUCTOR<10MH, J>	9	
C176		L40-1035-29	SMALL FIXED INDUCTOR<10MH, J>	8	
C177		L40-1035-29	SMALL FIXED INDUCTOR<10MH, J>	9	
C178		L40-1035-29	SMALL FIXED INDUCTOR<10MH, J>	8	
C179		L32-0368-05	BIAS OSCILLATING COIL	9	
C180		L32-0368-05	BIAS OSCILLATING COIL	8	
C181		L32-0536-05	BIAS OSCILLATING COIL	9	
C182		L78-0244-05	RESONATOR (4.000M)	9	

L:Scandinavia
Y:Far East, Hawaii
Y:AFES(Europe)

K:USA
T:England
X:Australia

P:Canada
E:Europe
M:Other Areas

J: Japan made
S: Singapore made

5: X-57
8: X-87
9: X-97

Δ indicates safety critical components.

No.5

* New Parts
Parts without Parts No. are not supplied.
Les articles non mentionnés dans le Parts No. ne sont pas fournis.
Teile ohne Parts No. werden nicht geliefert.

Ref. No. 参照番号	Address 位置	Parts No. 部品番号	Description 部品名/規格	Desti- nation 仕向	Re- marks 備考
C87		CE04LW1A471M	ELECTRØ 470UF 10WV	S	
C88		CE04KW1E221M	ELECTRØ 220UF 25WV	J	
C89		CE04LW1E221M	ELECTRØ 220UF 25WV	S	
C90		CE04DW1E331M	ELECTRØ 330UF 25WV	J	
C91		CE04EW1E331M	ELECTRØ 330UF 25WV	S	
C92		CE04LW1V100M	ELECTRØ 10UF 50WV	J	
C93		CE04LW1V100M	ELECTRØ 10UF 50WV	S	
C94		CE04LW1H101M	ELECTRØ 10UF 50WV	J	
C95		CE04LW1H101M	ELECTRØ 10UF 50WV	S	
C96		CE04LW1A101M	ELECTRØ 10UF 50WV	J	
C97		CE04LW1A101M	ELECTRØ 10UF 50WV	S	
C98		CE04LW1A101M	ELECTRØ 10UF 50WV	J	
C99		CE04LW1A101M	ELECTRØ 10UF 50WV	S	
C100		CE04LW1A101M	ELECTRØ 10UF 50WV	J	
C101		CE04LW1V100M	ELECTRØ 10UF 50WV	S	
C102		CE04LW1V100M	ELECTRØ 10UF 50WV	J	
C103		CE04LW1V100M	ELECTRØ 10UF 50WV	S	
C104		CE04LW1A101M	ELECTRØ 10UF 50WV	J	
C105		CE04LW1A101M	ELECTRØ 10UF 50WV	S	
C106		CE04LW1H101M	ELECTRØ 10UF 50WV	J	
C107		CE04LW1H101M	ELECTRØ 10UF 50WV	S	
C108		CE04LW1H101M	ELECTRØ 10UF 50WV	J	
C109		CE04LW1H101M	ELECTRØ 10UF 50WV	S	
C110		CE04LW1H101M	ELECTRØ 10UF 50WV	J	
C111		CE04LW1H101M	ELECTRØ 10UF 50WV	S	
C112		CE04LW1H101M	ELECTRØ 10UF 50WV	J	
C113		CE04LW1H101M	ELECTRØ 10UF 50WV	S	
C114		CE04LW1H101M	ELECTRØ 10UF 50WV	J	
C115		CE04LW1H101M	ELECTRØ 10UF 50WV	S	
C116		CE04LW1H101M	ELECTRØ 10UF 50WV	J	
C117		CE04LW1H101M	ELECTRØ 10UF 50WV	S	
C118		CE04LW1H101M	ELECTRØ 10UF 50WV	J	
C119		CE04LW1H101M	ELECTRØ 10UF 50WV	S	
C120		CE04LW1H101M	ELECTRØ 10UF 50WV	J	
C121		CE04LW1H101M	ELECTRØ 10UF 50WV	S	
C122		CE04LW1H101M	ELECTRØ 10UF 50WV	J	

L:Scandinavia
Y:Far East, Hawaii
Y:AFES(Europe)

K:USA
T:England
X:Australia

P:Canada
E:Europe
M:Other Areas

J: Japan made
S: Singapore made

5: X-57
8: X-87
9: X-97

Δ indicates safety critical components.

PARTS LIST

No.8

Table with columns: Ref. No., Address, Parts No., Description, Re-nation marks. Includes parts like DIODE, ZENER DIODE, IC, TRANSISTOR.

* New Parts
Parts without Parts No. are not supplied.
Les articles non mentionnés dans le Parts No. ne sont pas fournis.

J: Japan made
S: Singapore made
Indicates safety critical components.

No.7

Table with columns: Ref. No., Address, Parts No., Description, Re-nation marks. Includes parts like BINDING HEAD TAPPISTE SCREW, TRIMMING POT, MAGNETIC RELAY, ZENER DIODE.

* New Parts
Parts without Parts No. are not supplied.
Les articles non mentionnés dans le Parts No. ne sont pas fournis.

J: Japan made
S: Singapore made
Indicates safety critical components.

PARTS LIST

✕ New Parts
 Parts without Parts No. are not supplied.
 Les articles non mentionnés dans le Parts No. ne sont pas fournis.
 Teile ohne Parts No. werden nicht geliefert.

No.9

Ref. No. 参照番号	Address 位置	Parts No. 部品番号	Description 部品名 / 規格	Desti- nation 仕向
Q20		2SA1309A(Q,R)	TRANSISTOR	9 J
Q20		2SA1309A(Q,R)	TRANSISTOR	8 J
Q20		2SA933S(Q,R)	TRANSISTOR	8 S
Q21 -26		2SC1740S(Q,R)	TRANSISTOR	5 S
Q21 -26		2SC2458(Y,GR)	TRANSISTOR	5 J
Q21 -26		2SC2785(F,B)	TRANSISTOR	5 S
Q21 -26		2SC3311A(Q,R)	TRANSISTOR	5 J
Q21 -27		2SC1740S(Q,R)	TRANSISTOR	8 S
Q21 -27		2SC2458(Y,GR)	TRANSISTOR	9 J
Q21 -27		2SC2458(Y,GR)	TRANSISTOR	8 J
Q21 -27		2SC2785(F,B)	TRANSISTOR	8 S
Q21 -27		2SC3311A(Q,R)	TRANSISTOR	8 J
Q21 -27		2SC3311A(Q,R)	TRANSISTOR	9 J
Q28 -31		DTA124ES	DIGITAL TRANSISTOR	8
Q28 -31		DTA124ES	DIGITAL TRANSISTOR	9
Q28 -31		DTA124ES	DIGITAL TRANSISTOR	5
Q28 -29		DTA124ES	DIGITAL TRANSISTOR	5
Q28 -29		DTA124ES	DIGITAL TRANSISTOR	5
Q31		DTA124ES	DIGITAL TRANSISTOR	5
Q31		DTA124ES	DIGITAL TRANSISTOR	5
Q32 -33		DTA124ES	DIGITAL TRANSISTOR	5
Q32 -33		DTA124ES	DIGITAL TRANSISTOR	5
Q37		DTA124ES	DIGITAL TRANSISTOR	5
Q37		DTA124ES	DIGITAL TRANSISTOR	5
Q42 -46		DTA124ES	DIGITAL TRANSISTOR	5
Q42 -46		DTA124ES	DIGITAL TRANSISTOR	5
Q47 -48		2SC1740S(Q,R)	TRANSISTOR	6 S
Q47 -48		2SC2458(Y,GR)	TRANSISTOR	9 J
Q47 -48		2SC2458(Y,GR)	TRANSISTOR	8 J
Q47 -48		2SC2785(F,B)	TRANSISTOR	8 S
Q47 -48		2SC3311A(Q,R)	TRANSISTOR	9 J
Q49 -56		DTA124ES	DIGITAL TRANSISTOR	8 J
Q49 -56		DTA124ES	DIGITAL TRANSISTOR	8 J
Q49 -56		DTA124ES	DIGITAL TRANSISTOR	8 J
MECHANISM ASSY (D40-132X-XX)				
301	2A	A10-2399-08	HEAD CHASSIS CALKED ASSY	
302	1B	A11-0754-08	BASE CHASSIS ASSY	
303	1C	001-0138-08	FLYWHEEL ASSY LEFT	
306	2C	001-0139-08	FLYWHEEL ASSY RIGHT	MX
306	2C	001-0139-08	FLYWHEEL ASSY RIGHT	5B
306	2C	001-0139-08	FLYWHEEL ASSY RIGHT	
306	2C	001-0142-08	FLYWHEEL ASSY RIGHT	ET
308	2B	D10-3210-08	SHIFT LEVER	
309	2A	D10-3211-08	PLAY SHIFT LEVER	
310	2B	D10-3212-08	INTER LOCK LEVER	RIGHT
310	2A	D10-3220-08	INTER LOCK LEVER	LEFT
311	2B	D10-3241-08	EJECT LEVER	RIGHT
311	1A	D10-3242-08	EJECT LEVER	LEFT
312	1B	D10-3214-08	FR ARM	
313	1A	D10-3215-08	PLAY ARM	
314	1C	D10-3216-08	SHIFT SELECT LEVER	

L:Scandinavia
 Y:YF(X Far East, Hawaii)
 Y:YAF(E:Europe)
 K:USA
 T:England
 X:Australia
 P:Canada
 E:Europe
 M:Other Areas
J: Japan made
S: Singapore made
A: A DECK
B: B DECK
5: X-57
8: X-87
9: X-97
 ⚠ indicates safety critical components.

No.10

Ref. No. 参照番号	Address 位置	Parts No. 部品番号	Description 部品名 / 規格	Desti- nation 仕向
315	2B	D10-3217-08	TRIGGER ARM	
316	2B	D10-3218-08	SELECT ARM	
317	1C	D10-3219-08	BRAKE ARM	
319	1B	D13-0965-08	CLUTCH GEAR	
320	1B	D13-0966-08	REV GEAR	
321	1B	D13-0967-08	FR GEAR	
322	1B	D13-0968-08	REEL GEAR	
323	2C	D13-0970-08	PLAY CAM GEAR	
324	1A	D13-0974-08	PLAY GEAR ASSY	
325	2A	D13-0981-08	ROTATION GEAR	
326	2A	D13-0982-08	RETURN GEAR	
329	1B	D19-0270-18	REEL CAP	
330	1C	D19-0273-08	CLUTCH PULLEY ASSY	RIGHT
332	2B	D23-0277-08	HOUSING ASSY	LEFT
333	1A	D23-0270-08	HOUSING ASSY	
335	1C	E35-0264-08	MOTOR WIRE	
336	1C	E35-0267-08	FLAT WIRE 1SP	
337	2C	E35-0268-08	HEAD WIRE 5P	B
337	2C	E35-0290-08	HEAD WIRE 3P	A
338	1C	E40-4244-05	PIN CONNECTOR	
339	2A	G01-3500-08	TAPE GUIDE SPRING	
340	2A	G01-3428-08	RETURN GEAR SPRING	
341	1B	G01-3429-08	REEL SPRING	
342	1C	G01-3431-08	CLUTCH ARM SPRING	
343	1A	G01-3432-08	PLAY ARM SPRING	
344	1C	G01-3433-08	SHIFT SELECT LEVER SPRING	
345	2C	G01-3434-08	TRIGGER ARM SPRING	
346	2B	G01-3435-08	SHIFT LEVER SPRING	
347	2A	G01-3436-08	HEAD CHASSIS SPRING	
348	2B	G01-3437-08	PINCH ROLLER ARM SPRING	RIGHT
349	1A	G01-3438-08	PINCH ROLLER ARM SPRING	LEFT
350	2A	G01-3440-08	INTER LOCK LEVER SPRING	RIGHT
351	2A	G01-3441-08	INTER LOCK LEVER SPRING	LEFT
353	1B	G02-0913-08	PACK LOCK FLAT SPRING	
354	2A	G02-0994-08	AZIMUTH SPRING	
355	2A	G11-2117-08	HEAD WIRE CLAMPER	
356	1B	G16-0760-08	REFLECT SEAL	
357	2B	G16-0786-08	INSULATING SHEET	
358	2A	J21-5918-08	HEAD PLATE ASSY	
359	2A	J31-0850-08	RETURN GEAR COLLAR	
360	1A, 2B	J31-0851-08	EJECT LEVER COLLAR	
361	2B	J42-0183-08	REEL CAP BUSHING	
362	2A	J90-0680-08	CASSETTE GUIDE	
363	2A	J90-0692-08	TAPE GUIDE	LEFT
364	2A	J90-0693-08	TAPE GUIDE	RIGHT
365	1A, 2B	N09-2870-08	BINDING HEAD TAP TITE	M2.6X5
366	2A, 1C	N09-2871-08	TAPPING SCREW	M2X6
367	2A	N09-2872-08	TAPPING SCREW	M1.7X8
368	2A	N09-2953-08	WASHER HEAD SCREW	M2X10
369	2A	N09-2876-08	HEAD SCREW	
370	1A, 2A	N09-2877-08	TAP TITE SCREW	M2X4
371	2A	N09-2951-08	AZIMUTH SCREW	
372	1B	N19-1224-08	PLAY WASHER	φ4.1X6.5X0.25
373	1C	N19-1225-08	FLAT WASHER	φ2.1X4.0X0.25

L:Scandinavia
 Y:YF(X Far East, Hawaii)
 Y:YAF(E:Europe)
 K:USA
 T:England
 X:Australia
 P:Canada
 E:Europe
 M:Other Areas
A: A DECK
B: B DECK
 ⚠ indicates safety critical components.

PARTS LIST

No.11

* New Parts
 Parts without Parts No. are not supplied.
 Les articles non mentionnés dans le Parts No. ne sont pas fournis.
 Teile ohne Parts No. werden nicht geliefert.

Ref. No. 参照番号	Address 位置	Parts No. 部品番号	Description 部品名 / 規格	Desti- nation 仕向	Re- marks 備考
374	1B	N19-1285-08	FLAT WASHER /1.6X3.0X0.13		
375	1C	N19-1286-08	FLAT WASHER /2.3X4.0X0.25		
376	2A	N19-1287-08	FLAT WASHER /3.5X6.5X0.5		
377	1A	N19-1288-08	FLAT WASHER /1.6X3.0X0.5		
378	2B	N19-1289-08	FLAT WASHER /1.6X6.0X0.5		
379	2A	N19-1317-08	POLYSLIDER WASHER 4.45X7.0X0.2		
380	1B	N35-2604-46	BINDING HEAD MACHINE SCREW		
385	1C	S74-0006-08	LEAF SWITCH (REC.METAL Cr02)		
386	1C	S74-0007-08	LEAF SWITCH (PACK DETECT)		
388	2B	T94-0228-08	SOLENOID ASSY		
390	1C	W02-1130-08	ELECTRIC UNIT		
BM	1C	D16-0332-08	MAIN BELT		
BR	1C	D16-0331-08	REEL BELT		
PF	2B	D14-0341-08	PINCH ROLLER ASSY		
PR	2A	D14-0340-08	PINCH ROLLER ASSY		
MM	1B	T42-0599-08	DC MOTOR ASSY		
PH	2A	T31-0066-08	PLAYBACK HEAD		
RPEH	2A	T39-0015-08	REC/PLAYBACK/ERASE HEAD		A
RPEH	2A	T39-0020-08	REC/PLAYBACK/ERASE HEAD		B
PH1	1C	N3L5165K	PHOTO REFLECTOR		SB
R1		RD14862152J	RD 1.5K J 1/6W		

L:Scandinavia K:USA P:Canada
 Y:FXF (East, Hawaii) T:England E:Europe
 Y:AFES(Europe) X:Australia M:Other Areas

A: A DECK 5: X-57
 B: B DECK 8: X-87
 9: X-97

⚠ indicates safety critical components