

# Operating Instructions

AUDIO/VIDEO STEREO RECEIVER

# VSX-D3S

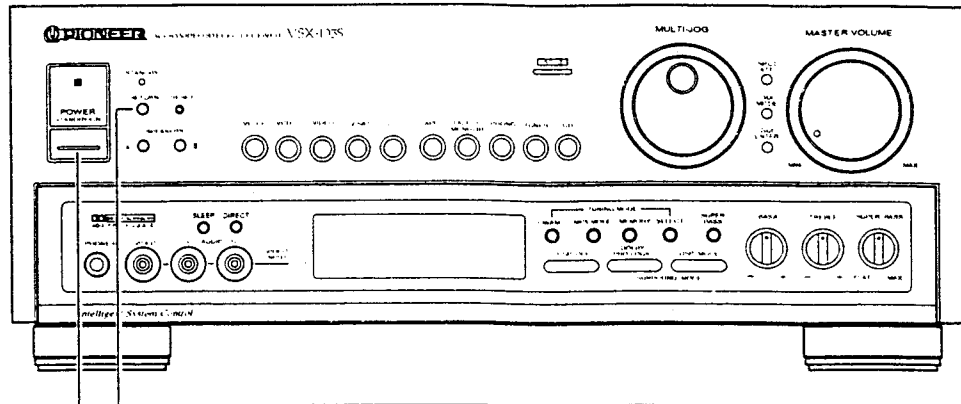

Thank you for buying this Pioneer product.

Please read through these operating instructions so you will know how to operate your model properly. After you have finished reading the instructions, put them away in a safe place for future reference.

In some countries or regions, the shape of the power plug and power outlet may sometimes differ from that shown in the explanatory drawings. However, the method of connecting and operating the unit is the same.

## IMPORTANT NOTICE

### [For U.S. and Canadian models]

The serial number for this equipment is located on the rear panel. Please write this serial number on your enclosed warranty card and keep it in a secure area. This is for your security.

### [For Canadian model]

**CAUTION:** TO PREVENT ELECTRIC SHOCK DO NOT USE THIS (POLARIZED) PLUG WITH AN EXTENSION CORD, RECEPTACLE OR OTHER OUTLET UNLESS THE BLADES CAN BE FULLY INSERTED TO PREVENT BLADE EXPOSURE.

**ATTENTION:** POUR PREVENIR LES CHOCS ELECTRIQUES NE PAS UTILISER CETTE FICHE POLARISEE AVEC UN PROLONGATEUR, UNE PRISE DE COURANT OU UNE AUTRE SORTIE DE COURANT, SAUF SI LES LAMES PEUVENT ETRE INSEREES A FOND SANS EN LAISSER AUCUNE PARTIE A DECOUVERT.

## DEMO MODE

- The demonstration mode is activated by turning on the power switch while holding down the RETURN button (from power standby condition). The demonstration will appear on the display.
- Press any button to cancel the demonstration. Activating the demonstration mode causes memory contents to return to their original default condition, except the tuner.

U.S. and Canadian models

NTSC

Multi-voltage model

NTSC/PAL

**WARNING:** TO PREVENT FIRE OR SHOCK HAZARD, DO NOT EXPOSE THIS APPLIANCE TO RAIN OR MOISTURE.

## RETURN function

This function returns the unit to its initial settings with the tuner ready to receive a broadcast. This is helpful during troubleshooting or when no sound is output. For details, refer to page 13.

## RESET function

Set the MASTER VOLUME to minimum before pressing the RESET button.

Use this function when normal operation is not possible due to external influences such as static electricity or lightning, or when operations are not functioning even when the operation switches are pressed. Press the RESET button to return to normal operating conditions.

# IMPORTANT



The lightning flash with arrowhead, within an equilateral triangle, is intended to alert the user to the presence of uninsulated "dangerous voltage" within the product's enclosure that may be of sufficient magnitude to constitute a risk of electric shock to persons.

**CAUTION**  
**RISK OF ELECTRIC SHOCK**  
**DO NOT OPEN**

**CAUTION:**  
**TO PREVENT THE RISK OF ELECTRIC SHOCK, DO NOT REMOVE COVER (OR BACK). NO USER-SERVICEABLE PARTS INSIDE. REFER SERVICING TO QUALIFIED SERVICE PERSONNEL.**



The exclamation point within an equilateral triangle is intended to alert the user to the presence of important operating and maintenance (servicing) instructions in the literature accompanying the appliance.

## SAFETY INSTRUCTIONS

**READ INSTRUCTIONS** — All the safety and operating instructions should be read before the appliance is operated.

**RETAIN INSTRUCTIONS** — The safety and operating instructions should be retained for future reference.

**HEED WARNING** — All warnings on the appliance and in the operating instructions should be adhered to.

**FOLLOW INSTRUCTIONS** — All operating and use instructions should be followed.

**WATER AND MOISTURE** — The appliance should not be used near water — for example, near a bathtub, washbowl, kitchen sink, laundry tub, in a wet basement, or near a swimming pool, etc.

**LOCATION** — The appliance should be installed in a stable location.

**WALL OR CEILING MOUNTING** — The appliance should not be mounted to a wall or ceiling.

**VENTILATION** — The appliance should be situated so that its location or position does not interfere with its proper ventilation. For example, the appliance should not be situated on a bed, sofa, rug, or similar surface that may block the ventilation openings; or, placed in a built-in installation, such as a bookcase or cabinet that may impede the flow of air through the ventilation openings.

**HEAT** — The appliance should be situated away from heat sources such as radiators, heat registers, stoves, or other appliances (including amplifiers) that produce heat.

**POWER SOURCES** — The appliance should be connected to a power supply only of the type described in the operating instructions or as marked on the appliance.

**POWER-CORD PROTECTION** — Power-supply cords should be routed so that they are not likely to be walked on or pinched by items placed upon or against them. Pay particular attention to cords at plugs, convenience receptacles, and the point where they exit from the appliance.

**POLARIZATION** — If your purchased product is provided with a polarized power plug, please read the following instructions. This product is equipped with a polarized alternating current line plug (a plug having one blade wider than the other). This plug will fit into the power outlet only one way. This is a safety feature. If you are unable to insert the plug fully into the outlet, try reversing the plug. If the plug should still fail to fit, contact your electrician to replace your obsolete outlet. Do not defeat the safety purpose of the polarized plug.

**CLEANING** — The appliance should be cleaned only with a polishing cloth or a soft dry cloth. Never clean with furniture wax, benzene, insecticides or other flammable liquids since they may corrode the cabinet.

**POWER LINES** — An outdoor antenna should be located away from power lines.

**NONUSE PERIODS** — The power cord of the appliance should be unplugged from the outlet when left unused for a long period of time.

**OBJECT AND LIQUID ENTRY** — Care should be taken so that objects do not fall and liquids are not spilled into the enclosure through openings.

**DAMAGE REQUIRING SERVICE** — The appliance should be serviced by a Pioneer authorized service center or qualified service personnel when:

- The power-supply cord or the plug has been damaged.
- Objects have fallen, or liquid has been spilled into the appliance.
- The appliance has been exposed to rain.
- The appliance does not appear to operate normally or exhibits a marked change in performance.
- The appliance has been dropped or the enclosure damaged.

**SERVICING** — The user should not attempt to service the appliance beyond that described in the operating instructions. All other servicing should be referred to qualified service personnel.

**OUTDOOR ANTENNA GROUNDING** — If an outside antenna is connected to the antenna terminal, be sure the antenna system is grounded so as to provide some protection against voltage surges and built-up static charges.

In the U.S.A. section 810 of the National Electrical Code, ANSI/NFPA 70, provides information with respect to proper grounding of the mast and supporting structure, grounding of the lead-in wire to an antenna discharge unit, size of grounding conductors, location of antenna discharge unit, connection to grounding electrodes, and requirements for the grounding electrode. See Fig. A.

**CART** — An appliance and cart combination should be moved with care. Quick stops, excessive force, and uneven surfaces may cause the appliance and cart combination to overturn.



NEC — NATIONAL ELECTRIC CODE

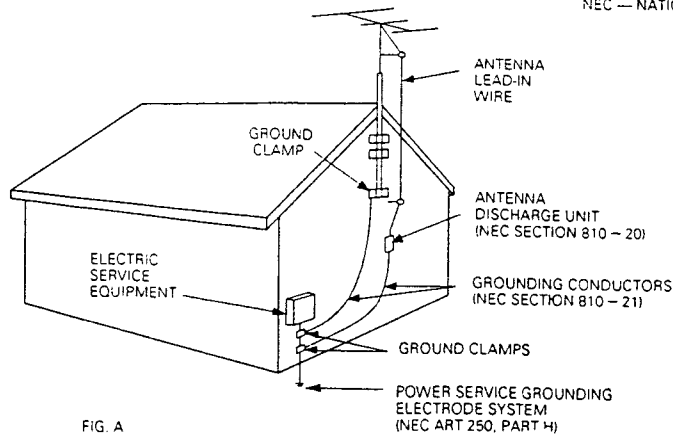

### Note to CATV system installer



This reminder is provided to call the CATV system installer's attention to Article 820-40 of the NEC that provides guidelines for proper grounding and, in particular, specifies that the cable ground shall be connected to the grounding system of the building, as close to the point of cable entry as practical.

### Information to User

Alteration or modifications carried out without appropriate authorization may invalidate the user's right to operate the equipment.

# INSPECTION CHECKLIST

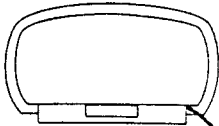
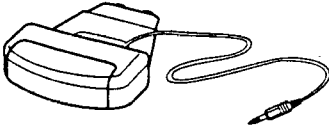
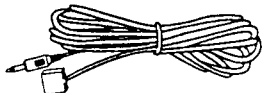
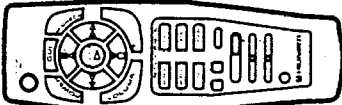
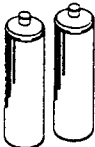
The Pioneer Receiver is packaged with the following items:

	FM T-type antenna
	AM Loop Antenna
	Main-Repeater
	Mini-Repeater
	Remote control unit
	Dry cell batteries (size "AA" IEC R6P) x 2
	Warranty Card (Not supplied in multi-voltage model.)
	Operating Instructions

If any of these items were not included in the package, contact the dealer where you purchased the product from to obtain the missing items or a complete replacement.

# CONTENTS

## BEFORE OPERATING

INSPECTION CHECKLIST .....	3
INSTALLATION .....	4
SETTING THE SWITCHES FOR THE MULTI-VOLTAGE MODEL ONLY .....	4
INSTALLATION PRECAUTIONS .....	5

## CONNECTIONS

ANTENNA CONNECTIONS .....	6
AUDIO SYSTEM CONNECTIONS .....	7
VIDEO SYSTEM CONNECTIONS .....	8
SPEAKER SYSTEM CONNECTIONS .....	9
IR REPEATER CONNECTION .....	10

## PANEL FACILITIES

REAR PANEL FACILITIES .....	11
FRONT PANEL FACILITIES .....	13
DISPLAY SECTION .....	15

## OPERATIONS

OPERATING THE TUNER .....	16
TUNING INTO STATIONS .....	16
FREQUENCY PRESETTING .....	16
LISTENING TO BROADCASTS USING PRESET TUNING ...	16
RECEIVING FM SIMULCAST TV PROGRAMS .....	17
OPERATING THE AUDIO/VIDEO COMPONENTS .....	17
PLAYBACK .....	17
RECORDING WITH A CASSETTE DECK .....	18
RECORDING WITH TAPE 1 .....	18
RECORDING WITH TAPE 2 .....	18
USING VCR 1, VCR 2 FOR AUDIO RECORDING .....	18
COPYING TAPES .....	18
VIDEO RECORDING .....	19
SURROUND EFFECT .....	19

## REMOTE CONTROL OPERATION

PUTTING BATTERIES INTO THE REMOTE CONTROL UNIT ...	20
REMOTE CONTROL RANGE .....	20
RECEIVER CONTROL BUTTONS .....	21
OPERATING OTHER COMPONENTS .....	21

## OPERATING USING GUI

RECEIVER CONTROL BUTTONS .....	24
OPERATING THE TUNER .....	25
MANUAL/AUTO TUNING .....	25
PRESET TUNING .....	25
OPERATING OTHER COMPONENTS .....	26
COPY OPERATION .....	28
USING THE VIDEO SIGNAL SELECTOR .....	28
SOUND EDIT OPERATION .....	29
SETTING THE SPEAKER MODE .....	29
LEVEL AND BALANCE ADJUSTMENT .....	30
REMOTE SET UP .....	31
ONE TOUCH OPERATION SET UP .....	33

TROUBLESHOOTING .....	34
-----------------------	----

## APPENDICES

APPENDIX A: SPECIFICATIONS .....	36
APPENDIX B: SURROUND EFFECT .....	37
APPENDIX C: DOLBY AC-3 SURROUND .....	38

# INSTALLATION

## SETTING THE SWITCHES FOR THE MULTI-VOLTAGE MODEL ONLY

### TWO VOLTAGE SELECTOR SWITCHES (Not available on U.S. and Canadian models)

Only multi-voltage models are provided with these switches. U.S. and Canadian models are not provided with these switches. Mains voltages in Saudi Arabia are 127 V and 220 V only. Never use this model with the 110 V setting in Saudi Arabia.

The line voltage selector switches are on the rear panel. Before your model is shipped from the factory, these switches are set to the power requirements of the destination. Check that they are set properly before plugging the power cord into the household wall socket. If the voltage is not properly set or if you move to an area where the voltage requirements differ, adjust the selector switches as follows.

1. Use a medium-size screwdriver.
2. First, insert the screwdriver in the groove of the voltage selector at the right, and adjust so that the tip of the groove points to the voltage value of your area.
3. Next, insert the screwdriver in the groove of the voltage selector at the left and adjust until the voltage is the same as at the right.

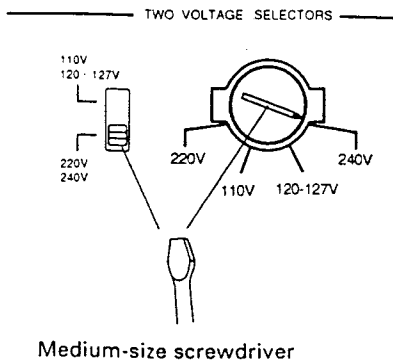

### CHANNEL STEP/FM DE-EMPHASIS SWITCH (Not available on U.S. and Canadian models)

The unit has been factory preset to the channel allocation and de-emphasis value for the area in which it is to be sold. If these values are set incorrectly, the tuned in frequency may be wrong, or sound may be distorted, resulting in an inability to reproduce reception signals at their proper sound quality. For this reason, be sure to confirm that the values are set correctly before first using the unit.

#### (FM 100 kHz/75 $\mu$ s, AM 10 kHz) position:

Set to this position for areas with an FM reception step of 100 kHz, de-emphasis 75  $\mu$ s and AM 10 kHz.

#### (FM 50 kHz/50 $\mu$ s, AM 9 kHz) position:

Set to this position, for areas with an FM reception step of 50 kHz, de-emphasis 50  $\mu$ s and AM 9 kHz.

#### NOTE:

When unsure about the channel allocation and de-emphasis values for your area, consult your dealer for correct information.

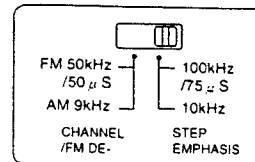

### PAL/NTSC SWITCH (Not available on U.S. and Canadian models)

This unit uses the TV screen to operate the system. Set the rear panel PAL/NTSC switch to match your TV's color system. The screen will be unclear if the color system does not match.



**INSTALLATION PRECAUTIONS**

**INSTALLING THE RECEIVER**

- Place the unit on a stable platform next to the television and stereo system to be used with the unit.
- When using the unit with a stereo system, your speakers should be placed away from your television (or TV monitor).
- Do not place heavy objects such as a television or TV monitor on top of the unit.
- Do not place the unit on top of your TV set or TV monitor. Also, keep the unit away from devices such as cassette decks which are sensitive to magnetic fields.

If the cassette deck is installed in the **A** positions as shown in the drawing below, it may be adversely affected during playback. If possible, it is better to install it in the **B** position.

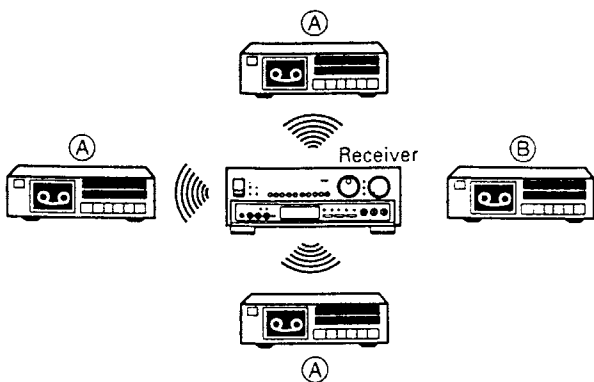

**INSTALL THE RECEIVER IN A WELL-VENTILATED PLACE AWAY FROM HEAT AND HUMIDITY**

Do not install the unit in a location subject to direct sunlight, or near a stove or radiator, etc. This could adversely affect the cabinet and internal components. Also, avoid installing the unit in a humid or dusty location. This could result in a malfunction or accident. Do not install near a cooking stove where the unit could be affected by smoke, steam, or heat. Avoid placing the unit on surfaces such as shaggy carpets, beds and sofas which may block ventilation under the unit and may cause damage.

- The rear panel vents are designed to disperse heat from the unit. Be careful that curtains or other items do not block the vents.
- To improve heat dispersion, set the unit so that it is at least 20 cm (8 inches) away from the wall.

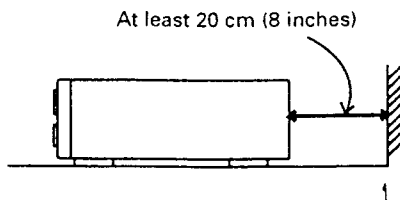

**POWER-CORD CAUTION**

Handle the power cord by the plug. Do not pull out the plug by tugging the cord and never touch the power cord when your hands are wet as this could cause a short circuit or electric shock. Do not place the unit, a piece of furniture, etc., on the power cord, or pinch the cord. Never make a knot in the cord or tie it with other cords. The power cords should be routed such that they are not likely to be stepped on. A damaged power cord can cause a fire or give you an electrical shock. Check the power cord once in a while. When you find it damaged, ask your nearest PIONEER authorized service center or your dealer for a replacement.

**SURROUND SPEAKER INSTALLATION EXAMPLE**

To get the best effect out of the surround system, place the speakers as shown below.

**An example for center speaker location**

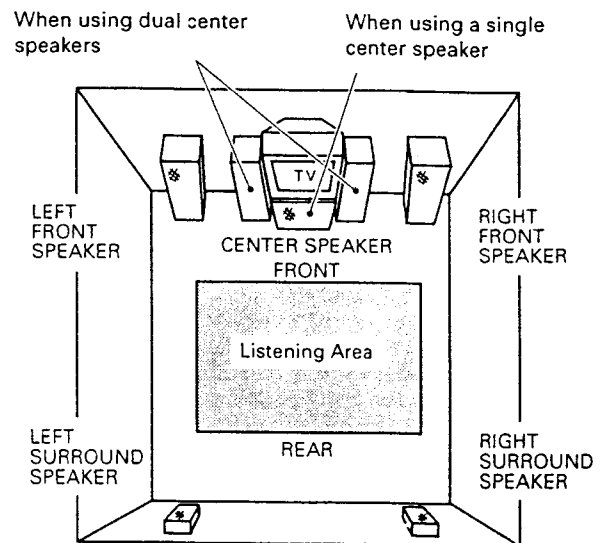

**NOTE:**

- To avoid interference with the picture on a nearby TV set, use magnetically shielded speaker systems. This is particularly important for the center speaker since it is usually located closest to the TV.
- Position the left and right channel speakers at equal distances from the TV set and approximately 1.8 m (6 feet) from each other.
- Position the center speaker above, below, or behind the TV set. Sound may not appear to coincide with the picture if you position it next to the TV set.
- Rear speakers are best positioned slightly above ear level.

You can set this unit to match the requirements and specifications of your stereo system's speakers (whether or not center speaker(s), rear speakers or a sub-woofer are used, speaker size, etc.) to assure optimum sound quality. Before using, perform settings in the SPEAKER MODE (refer to page 29).

**NOTE:**

This unit does not feature conventional switching between NORMAL/WIDE/PHANTOM center modes.

# CONNECTIONS

## ANTENNA CONNECTIONS

### NOTE FOR FM ANTENNA:

Stretch the antenna out to its full length and affix it to a wall, etc.

### NOTE FOR AM LOOP ANTENNA:

The antenna should be placed at a distance from the receiver, and should not be allowed to touch metallic objects. Avoid placing it near CD players, personal computers, television sets and other devices generating radio frequencies.

Accessory FM T-type antenna

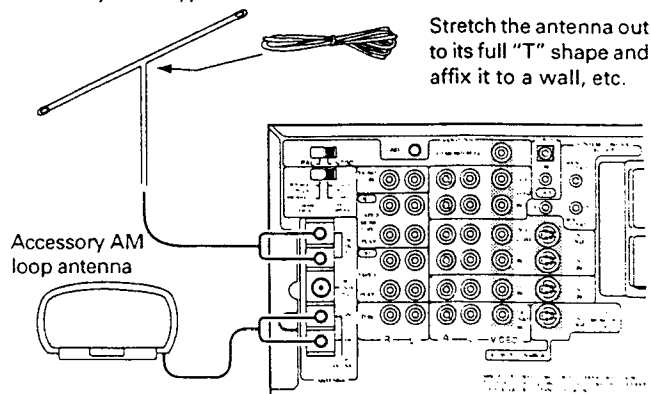

Illustration shows Multi-voltage model.

### ■ OUTDOOR FM ANTENNA

The main advantage of FM over AM is the quality of the broadcast signal. In order to benefit fully from the high signal quality of FM broadcasts, it is recommended that a special-purpose FM antenna be installed. In weak signal areas, a multi-element (3-, 5-, or 7-element) antenna should be used.

### ■ GROUNDING

Grounding is recommended if reception of FM programs is impaired by noise. To ground, connect a thick polyvinyl insulated wire to the GND terminal and attach the other end to a metal water pipe or grounding bar or wind it around a copper plate and bury it.

#### CAUTION:

Never connect a wire to a gas pipe for grounding since sparks may ignite the gas.

### ■ EXTERNAL AM ANTENNA

If it is not possible to obtain adequate AM reception even by changing the orientation of the AM loop antenna, a separate indoor antenna, or an outdoor antenna should be installed.

#### INDOOR AM ANTENNA

Use a vinyl insulated wire (5 — 6 m, 17 — 20 feet), and connect one end to the AM antenna terminal and affix the other end to the wall or ceiling, as high as possible.

#### OUTDOOR AM ANTENNA

If reception quality is not improved sufficiently even when an indoor antenna is used, a vinyl insulated wire should be installed outside and fixed in place.

#### NOTE:

Do not detach the AM loop antenna when using an indoor or an outdoor AM antenna.

### Setting Up the AM Antenna

- Insert the claw on the bottom of the antenna into the groove in the leg.
- Place the antenna on a level surface and rotate it to locate the orientation that yields the best reception.
- Use the attachment hole in the leg to screw to a wall or other location, then insert the claw on the bottom of the antenna into the groove in the leg (affixing the antenna in the direction that gives the best reception.)

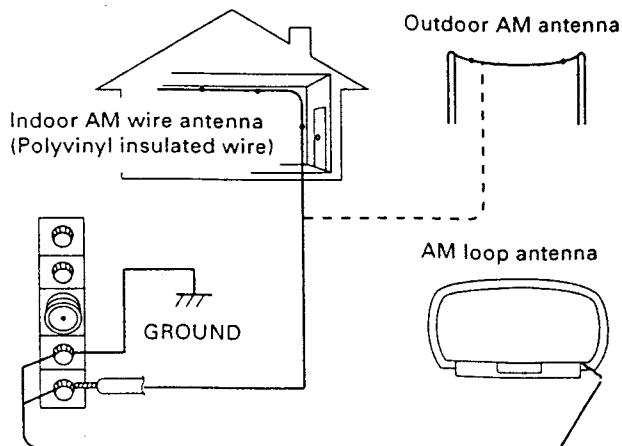
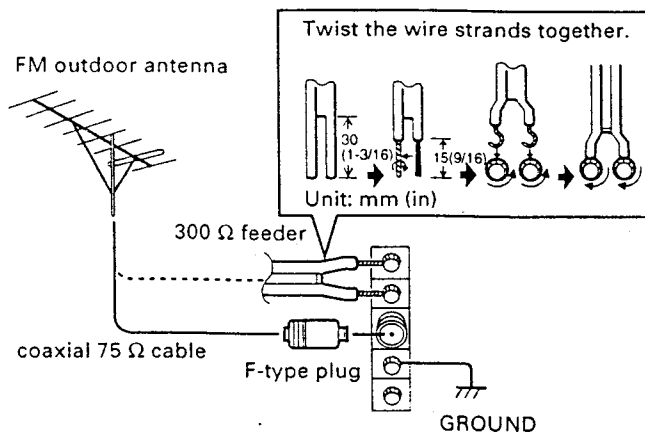
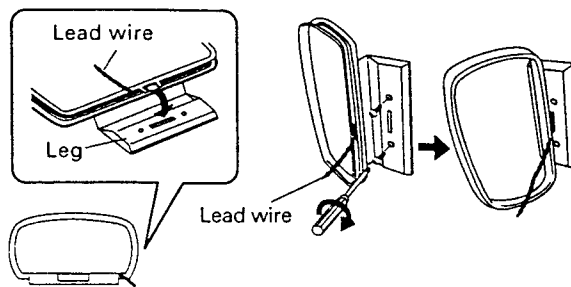

**AUDIO SYSTEM CONNECTIONS**

**NOTE:**

Dolby Surround will not operate correctly if the signal passes through a graphic equalizer. When using Dolby Surround, turn off the TAPE 2 MONITOR button or set the graphic equalizer for flat response or to its through (defeat) setting.

★ Connect when using a PIONEER projection monitor receiver's built-in speaker as a center speaker. Refer to the projection monitor's operating instructions for details concerning connection and operation.

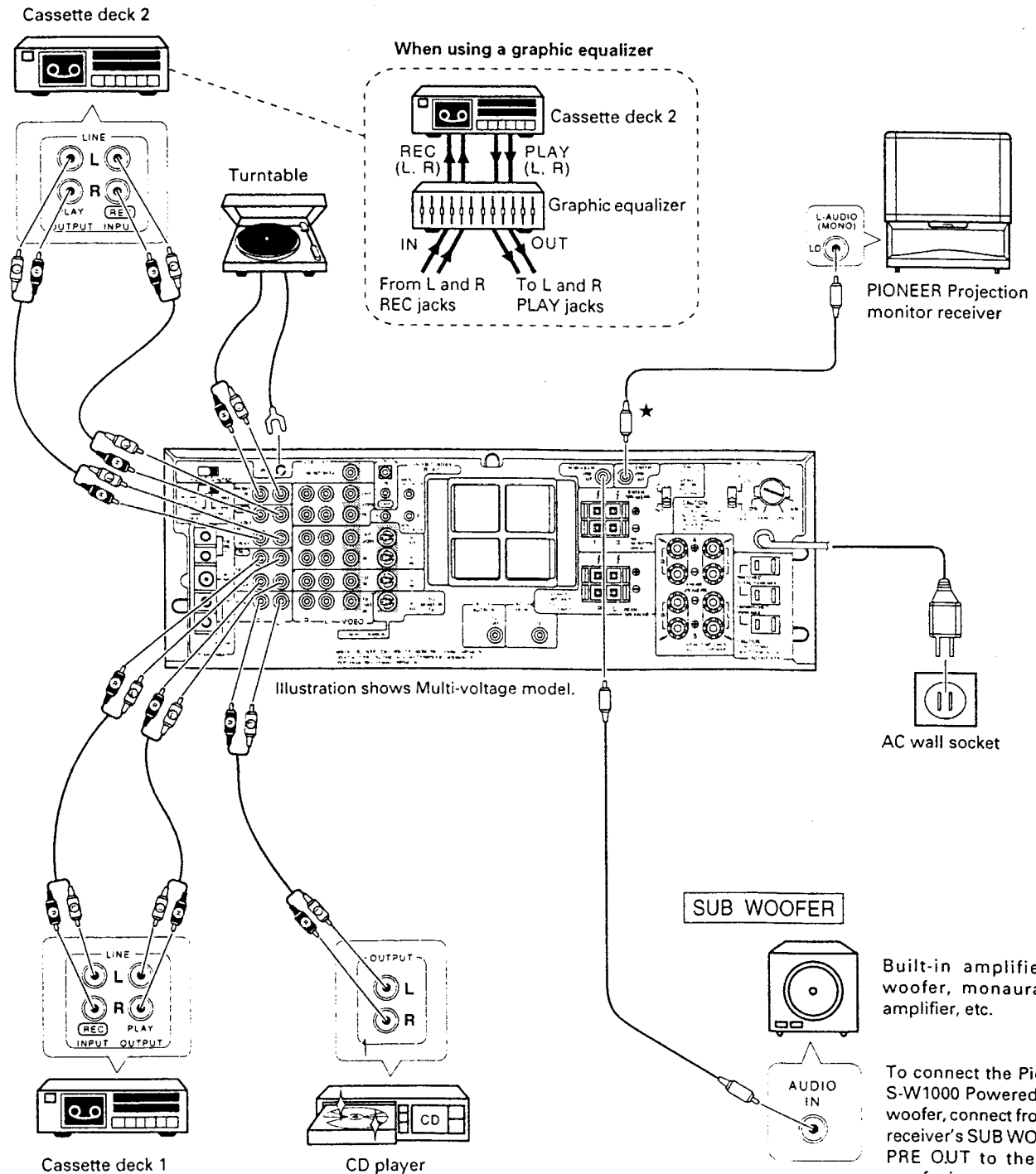

Illustration shows Multi-voltage model.

**SUB WOOFER**

Built-in amplifier woofer, monaural amplifier, etc.

To connect the Pioneer S-W1000 Powered Subwoofer, connect from the receiver's SUB WOOFER PRE OUT to the subwoofer input.

**NOTE:**  
Before connecting pin jacks, speaker cables and other jacks and cables, switch power to the unit OFF, and wait for about one hour. (When power is ON, the rear panel may become very hot.)

# CONNECTIONS

## VIDEO SYSTEM CONNECTIONS

### FRONT PANEL

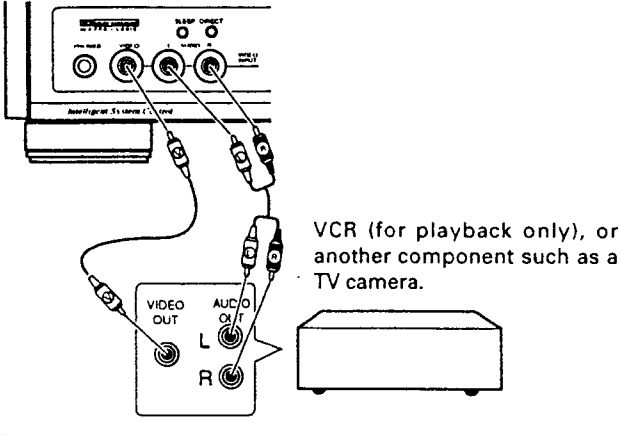

### THE S-VIDEO CONNECTORS

When using the VCR 1, LD and TO MONITOR TV jacks with components which have S-VIDEO connectors, they can be connected to the S-VIDEO connectors.

For the operation of components connected to S-VIDEO connectors, refer to the instruction manuals of the corresponding components.

#### NOTE:

- In this unit, the S-VIDEO connectors (Y-C separate) and the regular pin jacks are independent, so any signal input through a pin jack must be output from the pin jack, and any signal input through an S-VIDEO connector must be output through the S-VIDEO connector.
- Do not connect a different component to the same function's S-VIDEO connector and regular pin jacks.
- The S-VIDEO connector is for the video portion only, so be sure to also make the audio connections.

### How to use S-VIDEO connectors



S-VIDEO jack

Check the position of the holes and insert.

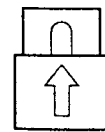

S-VIDEO plug

For the method of switching the TV monitor S-VIDEO connector/VIDEO jack, refer to the TV monitor's instruction manual.

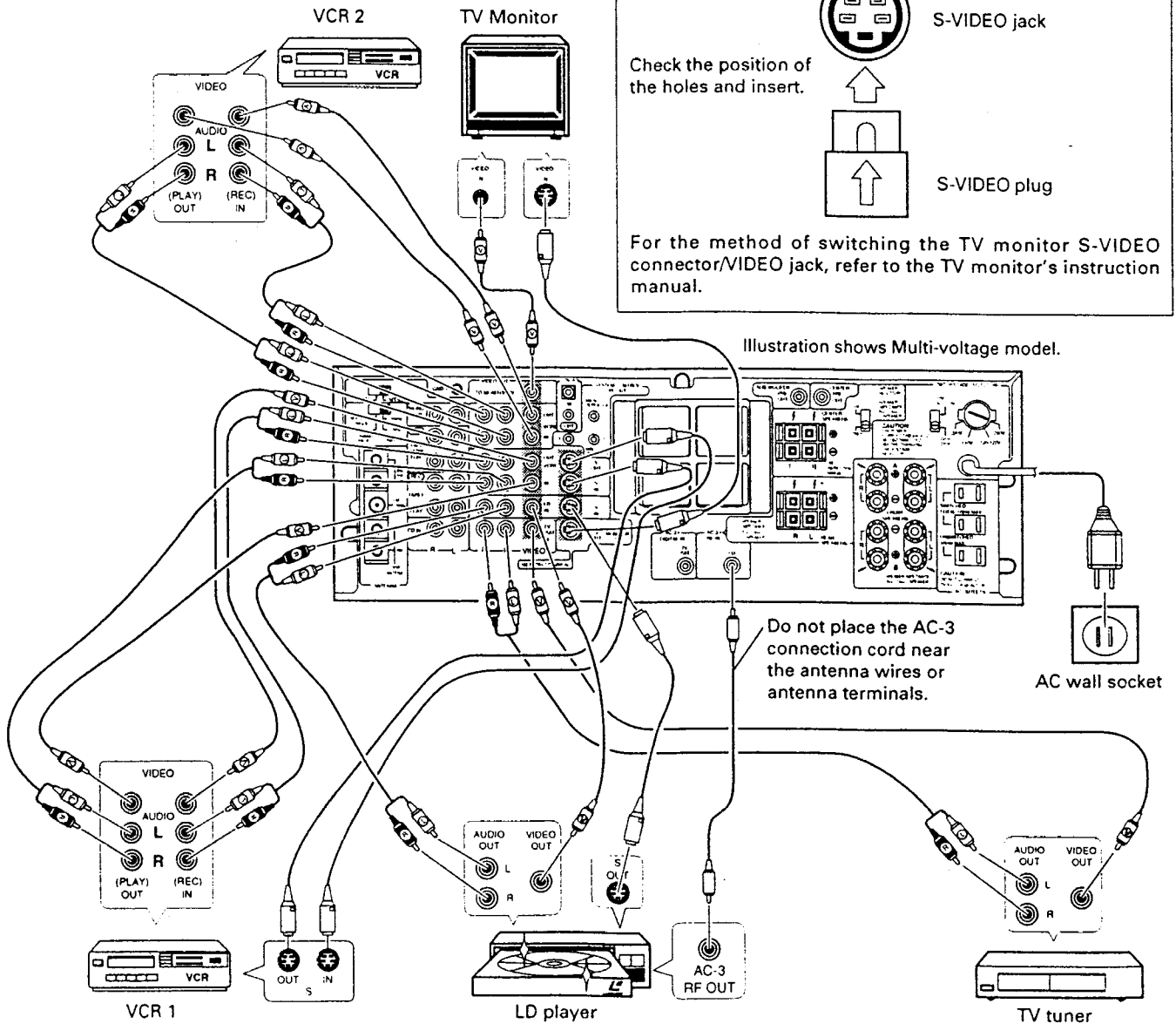

#### NOTE:

Before connecting pin jacks, speaker cables and other jacks and cables, switch power to the unit OFF, and wait for about one hour. (When power is ON, the rear panel may become very hot.)



**SPEAKER SYSTEM CONNECTIONS**

**NOTE:**

Use speakers with an impedance of 8 Ω to 16 Ω.

When connecting speakers to the FRONT SPEAKERS B terminals, the procedure is the same as that used for connecting speakers to the FRONT SPEAKERS A terminals.

**NOTE:**

- Do not allow any of the cord's conductors to protrude from the terminals or touch any other conductors. Malfunctioning or breakdowns may occur when conductors come into contact with each other.
- If you have one pair of speakers only, connect it to front speaker terminals A or B.
- Be sure to connect single rear speaker to the L channel.

You can set this unit to match the requirements and specifications of your stereo system's speakers (whether or not center speaker(s), rear speakers or a sub-woofer are used, speaker size, etc.) to assure optimum sound quality. Before using, perform settings in the SPEAKER MODE (refer to page 29).

**NOTE:**  
This unit does not feature conventional switching between NORMAL/WIDE/PHANTOM center modes.

**Speaker cord connection**

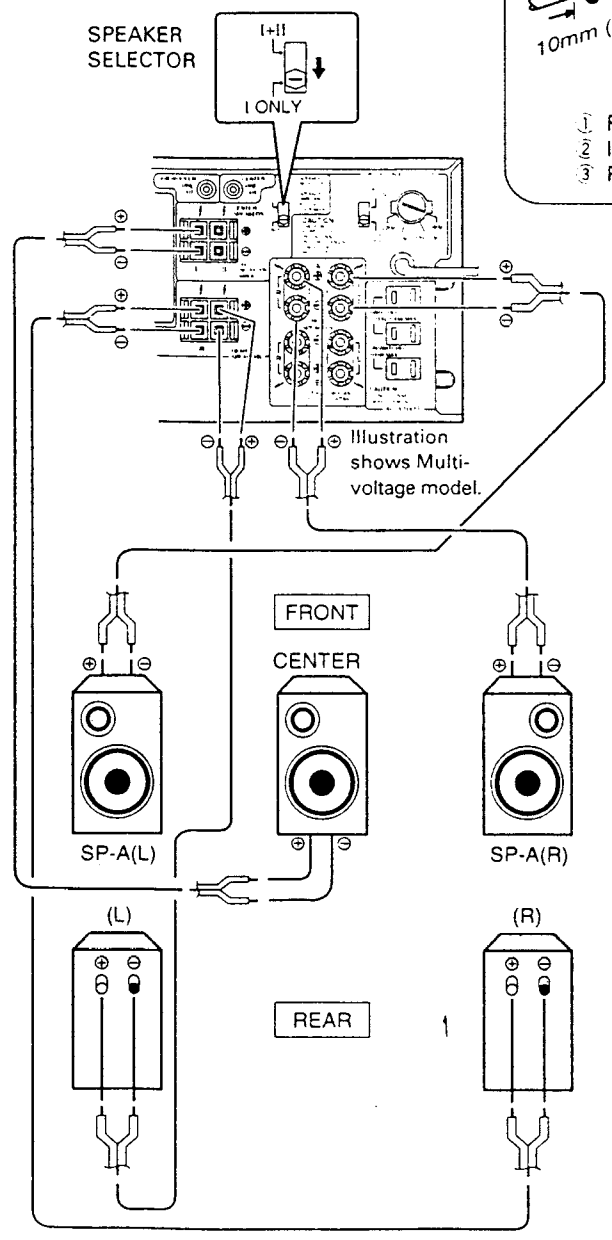
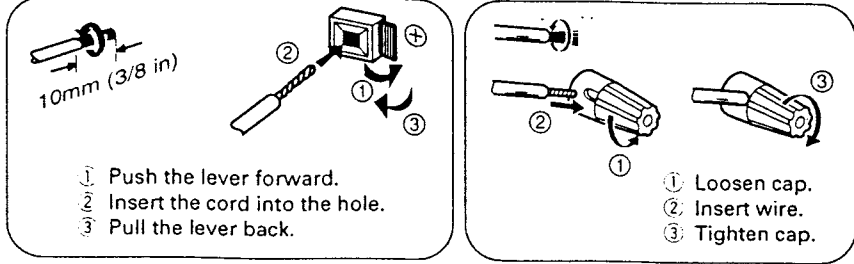

**Connecting Two Center Speakers for Dual Center**  
There are two sets of terminals for center speakers on the main unit, so you can connect two speakers. When you cannot install a speaker under or behind your TV, installing speakers either side of the TV as a center speaker is just as effective.

When the SPEAKER SELECTOR switch is in the "I + II" position, be sure to connect two speakers. If only one speaker is connected, there will be no sound.

Both speaker systems should have an impedance of 4 Ω to 16 Ω.

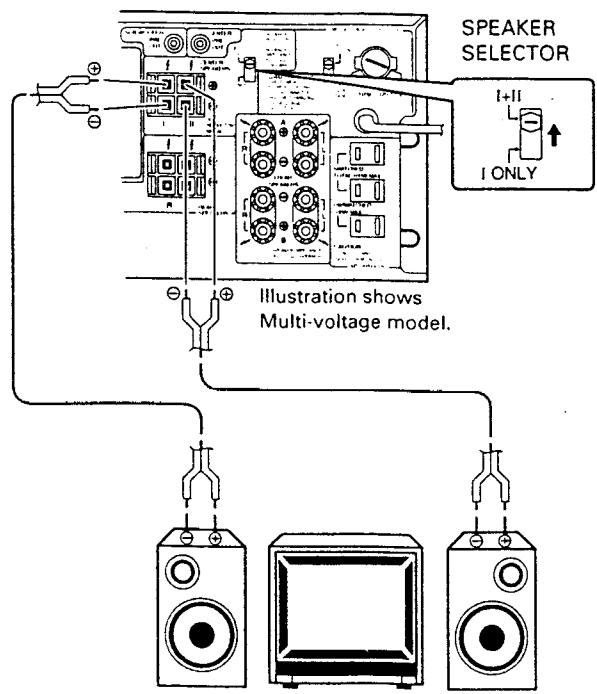

**NOTE:**  
Before connecting pin jacks, speaker cables and other jacks and cables, switch power to the unit OFF and unplug the power cord. After you connect all the cables, turn the power back on.

## CONNECTIONS

### IR REPEATER CONNECTION

Connecting a supplied IR Repeater lets you also control other components with this unit's remote control.

**NOTE:**

To operate components not made by Pioneer, perform *REMOTE SET UP* (page 31) after connecting an IR Repeater.

Remote control signals directed towards this unit or GUI operation signals are transmitted from the repeater as infrared signals, enabling control of other components.

There are two kinds of infrared repeaters. Connect either or both to match the remote control requirements of different components.

#### MAIN-REPEATER

Use this to operate other components with this unit's remote control or to operate using GUI on-screen indications.

Install on top of this unit as shown in the figure.

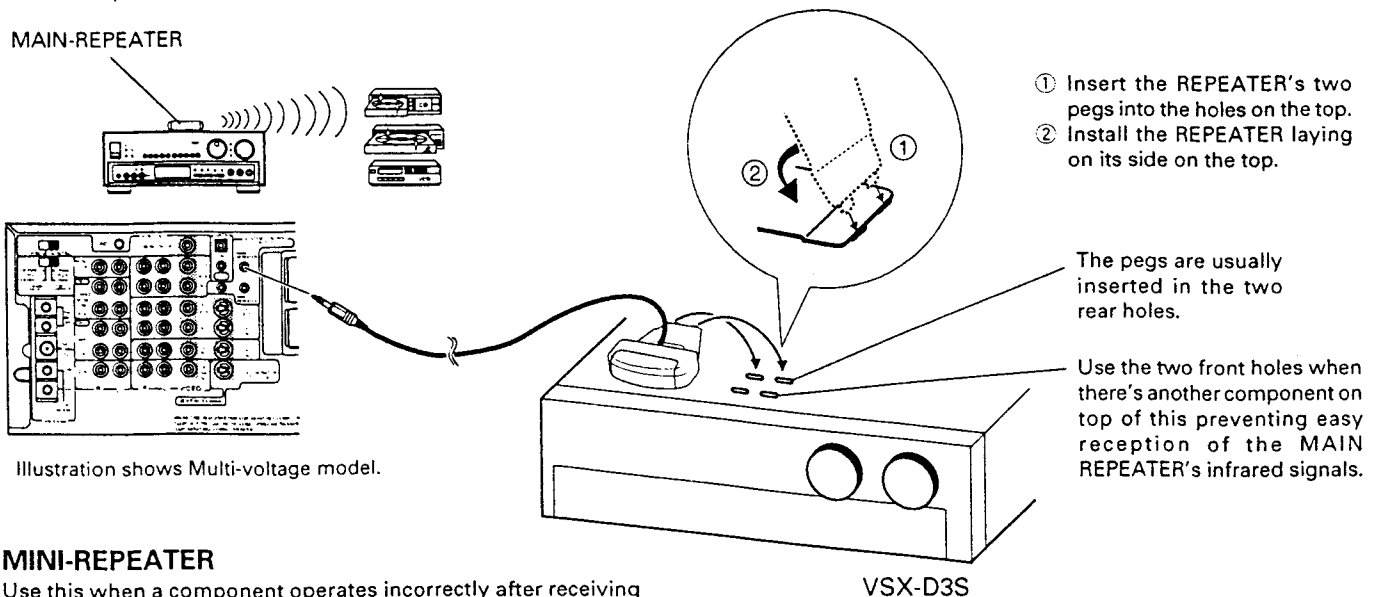

#### MINI-REPEATER

Use this when a component operates incorrectly after receiving a signal from this unit's remote control, or when it is difficult for a component to receive signals from the Main-Repeater. Stick it directly on the remote control sensor window.

There are two MINI-REPEATER terminals.

If you need another Mini-Repeater, contact your nearest Pioneer Service Center.

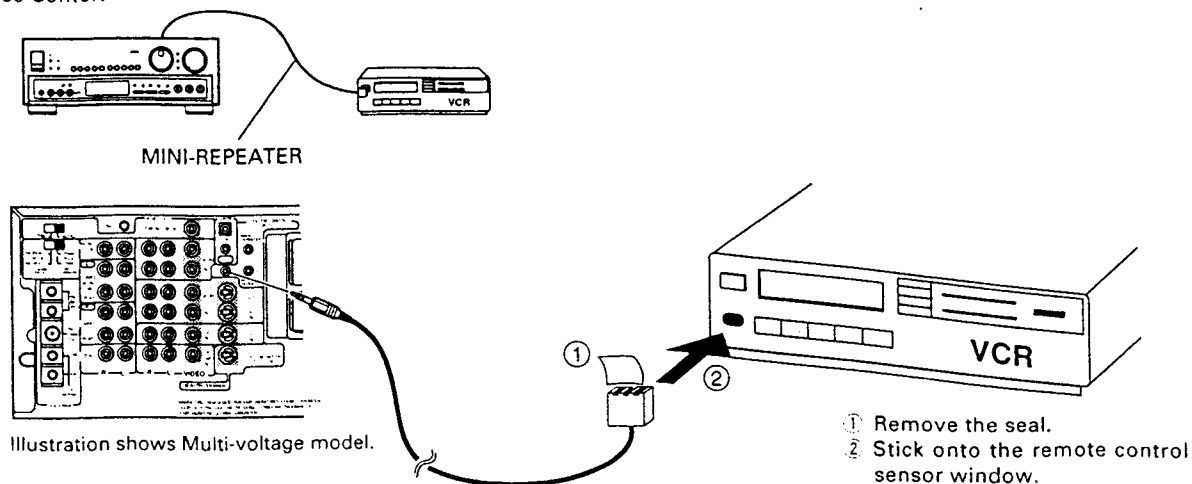

**NOTE:**

To prevent possible damage, be careful to avoid accidentally connecting the MINI-REPEATER to the MAIN-REPEATER terminals.

**NOTE:**

Before connecting the MAIN-REPEATER or MINI-REPEATER, switch power to the unit OFF, and wait for about one hour. (When power is ON, the rear panel may become very hot.)

# REAR PANEL FACILITIES

Illustration shows Multi-voltage model.

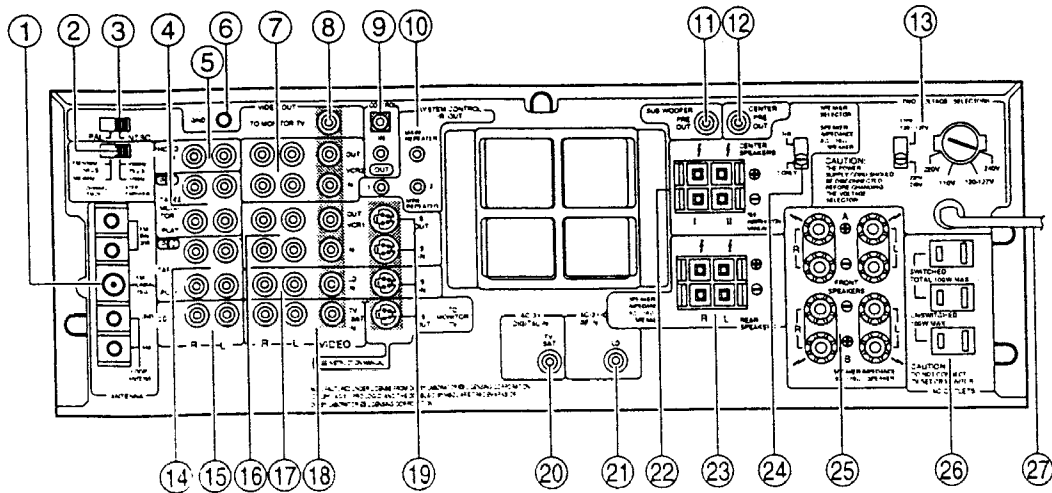

## ① FM/AM ANTENNA terminals

Use these antenna terminals for reception of normal FM and AM broadcasts.

## ② CHANNEL STEP switch (Multi-voltage model only)

See page 4.

## ③ PAL/NTSC switch (Multi-voltage model only)

See page 4.

## ④ TAPE 2 MONITOR jacks

Connect to audio components such as a second cassette deck or a graphic equalizer.

## ⑤ PHONO input jacks

Connect to the output cables from a turntable.

## ⑥ GND terminal

Connect the turntable ground lead to this terminal.

## ⑦ VCR 2 jacks

[VIDEO OUT]

Connect to the VCR 2 VIDEO INPUT jack.

[AUDIO OUT (L, R)]

Connect to the VCR 2 AUDIO INPUT jacks.

[VIDEO IN]

Connect to the VCR 2 VIDEO OUTPUT jack.

[AUDIO IN (L, R)]

Connect to the VCR 2 AUDIO OUTPUT jacks.

## ⑧ VIDEO OUT (TO MONITOR TV) jack

Connect to a monitor TV or to TV sets with video input terminals to watch program materials from a VCR or LD player connected to this unit.

## ⑨ CONTROL IN/OUT jacks

**IN** : Connect this jack to other Pioneer components when using those components to control this unit.

**OUT** : Connect this jack to other Pioneer components when using the remote control of this unit to control the other components.

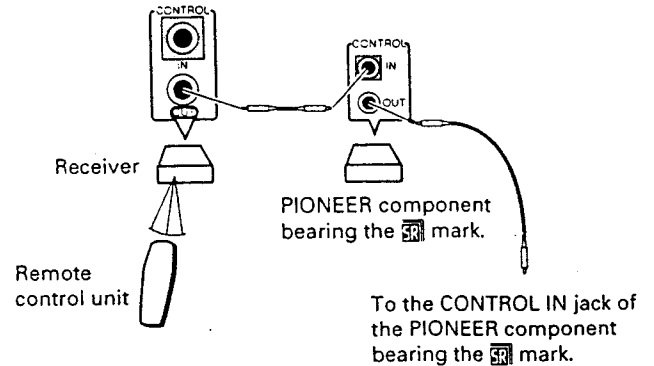

## NOTE:

- If there is a plug in this unit's CONTROL IN jack, Intelligent System Control and GUI operation are not possible.
- The receiver's remote sensor does not function when a plug is inserted in the IN jack. To operate, point a remote control unit other than this unit's supplied remote control unit at the remote sensor on the component to which the receiver's IN jack is connected.
- You cannot use the supplied remote control unit to operate this unit via another component's remote sensor.

## ⑩ SYSTEM CONTROL IR OUT jacks

To operate other components with this unit's remote control or with GUI, connect the supplied repeater. (See page 10.)

**MINI-REPEATER 1, 2:**

Connect the supplied Mini-Repeater.

**MAIN-REPEATER:**

Connect the supplied Main-Repeater.

## ⑪ SUB WOOFER PRE OUT jack

When you play back the low frequencies with a sub-woofer, connect to a powered sub-woofer.

## ⑫ CENTER PRE OUT jack

Connect when using a PIONEER projection monitor receiver's built-in speaker as a center speaker. Refer to the projection monitor's operating instructions for details concerning connection and operation.

## REAR PANEL FACILITIES

### ⑬ TWO VOLTAGE SELECTORS switches (Multi-voltage model only)

See page 4.

### ⑭ TAPE 1 jacks

Connect to the first cassette deck.

### ⑮ CD input jacks

Connect to the output jacks of a compact disc player.

### ⑯ VCR 1 jacks

[VIDEO OUT]

Connect to the VCR 1 VIDEO INPUT jack.

[AUDIO OUT (L, R)]

Connect to the VCR 1 AUDIO INPUT jacks.

[VIDEO IN]

Connect to the VCR 1 VIDEO OUTPUT jack.

[AUDIO IN (L, R)]

Connect to the VCR 1 AUDIO OUTPUT jacks.

### ⑰ LD input jacks

Connect to an LD player's output jacks (audio, video).

### ⑱ TV/SAT (Satellite) jacks (input)

Use these jacks if you wish to connect a TV tuner with both video and audio outputs.

### ⑲ S (connector) video jacks

When used in conjunction with a VCR, LD player or TV monitor equipped with S video jacks, connect to these jacks. (Refer to page 8.)

#### ● TO MONITOR TV jack

This unit uses the TV screen to operate the system. Set the rear panel PAL/NTSC switch (③) to match your TV's color system (Multi-voltage model only). The screen will be unclear if the color system does not match.

### ⑳ AC-3 • DIGITAL IN (TV/SAT) jack

This jack is ready for future AC-3 system digital TV audio broadcasts.

#### NOTE:

Do not connect to a CD or DAT coaxial digital audio output.

### ㉑ AC-3 • RF IN (LD) jack

Connect to an LD player's AC-3 • RF OUT jack.

### ㉒ CENTER SPEAKERS terminals

Connect the center speaker(s) to these terminals.

#### NOTE:

Do not allow any of the cord's conductors to protrude from the terminals or touch any other conductors. Malfunctions or breakdowns may occur when conductors come into contact with each other.

Use a center speaker with an impedance of 8  $\Omega$  to 16  $\Omega$ . (If you connect two center speakers, use speakers with an impedance of 4  $\Omega$  to 16  $\Omega$ . Refer to ㉔.)

### ㉓ REAR SPEAKERS terminals

Connect the rear speakers to these terminals.

#### NOTE:

Do not allow any of the cord's conductors to protrude from the terminals or touch any other conductors. Malfunctions or breakdowns may occur when conductors come into contact with each other.

Use rear speakers with an impedance of 8  $\Omega$  to 16  $\Omega$ .

### ㉔ CENTER SPEAKER SELECTOR switch

This switch changes the speaker impedance when only one center speaker is connected, or two speakers are connected.

#### When only one speaker is connected:

Be sure to set the switch to "I ONLY" (down side), and always connect a speaker with an impedance of 8  $\Omega$  to 16  $\Omega$  to the I terminal.

#### When two speakers are connected:

Be sure to set the switch to "I + II" (up side), and always use speakers with an impedance of 4  $\Omega$  to 16  $\Omega$ .

#### NOTE:

Switch the CENTER SPEAKER SELECTOR when the unit power supply is at STANDBY. Do not switch the selector when the power supply is at ON.

### ㉕ FRONT SPEAKERS terminals

A : Connect to the first set of speakers.

B : Connect to the second set of speakers.

#### NOTE:

Do not allow any of the cord's conductors to protrude from the terminals or touch any other conductors. Malfunctions or breakdowns may occur when conductors come into contact with each other.

Use front speakers with an impedance of 8  $\Omega$  to 16  $\Omega$ .

### ㉖ AC OUTLETS

(U.S. and Canadian models)

[SWITCHED TOTAL 100 W (0.8 A) MAX]

Power supplied through these outlets is turned on and off by the receiver's POWER switch. Total electrical power consumption of connected equipment should not exceed 100 W (0.8 A).

[UNSWITCHED 100 W (0.8 A) MAX]

Power flows continually to this outlet, regardless of whether the receiver is switched ON or OFF. Electrical power consumption of the connected equipment should not exceed 100 W (0.8 A).

(Multi-voltage model)

[SWITCHED TOTAL 100 W MAX]

Power supplied through these outlets is turned on and off by the receiver's POWER switch. Total electrical power consumption of connected equipment should not exceed 100 W.

[UNSWITCHED 100 W MAX]

Power flows continually to this outlet, regardless of whether the receiver is switched ON or OFF. Electrical power consumption of the connected equipment should not exceed 100 W.

#### NOTE:

● This unit should be disconnected by removing the power plug from the wall socket when not in regular use, e.g. when on vacation.

● Do not connect appliances with high power consumption such as heaters, irons or television sets to these AC OUTLETS in order to avoid overheating and fire risk. This can cause the receiver to malfunction.

**CAUTION:**  
DO NOT CONNECT A MONITOR OR TV SET TO THIS UNIT'S AC OUTLETS.

### ㉗ Power cord

# FRONT PANEL FACILITIES

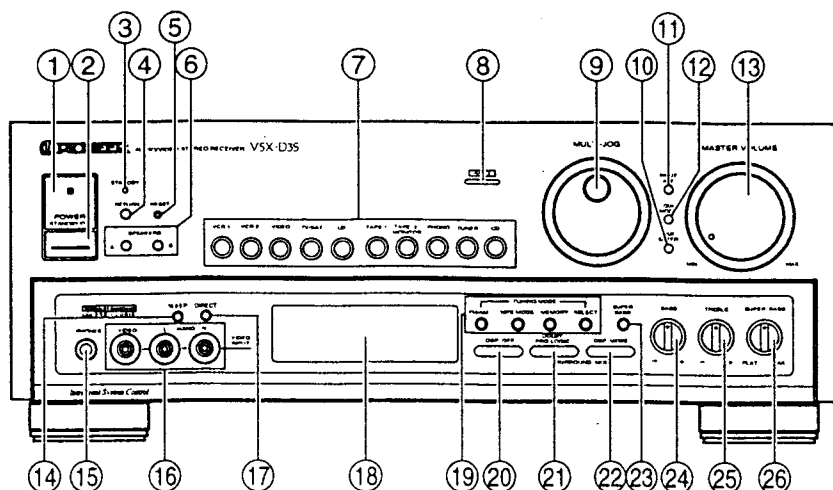

## ① Remote sensor

## ② POWER STANDBY/ON switch

This is the switch for electric power.

**ON** : When set to the ON position, power is supplied and the unit becomes operational.

**STANDBY** : When set to the STANDBY position, the main power flow is cut and the unit is no longer fully operational. A minute flow of power feeds the unit to maintain operation readiness.

### (Timer ON/OFF possible)

When the unit is switched ON, ON/OFF control can be performed by means of the optional timer.

### NOTE:

- When the power is initially turned ON, muting will be applied to prevent sound from being output for about 5 seconds.
- If the unit is on and you switch power off and then on again, it takes about three seconds for operation to resume. This is not a malfunction.

## ③ STANDBY indicator

The STANDBY indicator lights when the power is set to STANDBY, and goes out when set to ON.

## ④ RETURN button

Press this button to return the receiver to its initial state. TUNER is selected at this initial state. Adjust the sound level by using the MASTER VOLUME control.

TAPE 2 MONITOR ..... OFF      MUTING ..... OFF  
 DSP ..... OFF      FUNCTION ..... TUNER  
 SUPER BASS ..... OFF

And SPEAKERS buttons switch as follows.

Before pressing the RETURN button	After pressing
Both A and B are off	→ Only A is on
Only A is on	→ No change
Only B is on	→ Both A and B are on
Both A and B are on	→ No change

### NOTE:

Press the RETURN button, and the frequency last selected is received. If reception of the frequency last selected is not possible, the mode automatically switches to AUTO TUNING.

## ⑤ RESET button

Use this when normal operation is not possible because of external influences such as static electricity, lightning or when operations are not functioning even when operation buttons are pressed. Press this button to return to normal operating conditions.

(The input selector automatically switches to TUNER, and SPEAKERS button A is the only one on.

Also, the tuner station memory, surround settings, and remote control REMOTE SET UP settings are all returned to their initial defaults.)

If you press this button when the power is ON, the unit switches to POWER STANDBY.

## ⑥ SPEAKERS buttons (A, B)

On/off switches for the A and B speaker systems.

## ⑦ Input selector buttons

**VCR 1** : Press when performing playback on a first VCR unit.

**VCR 2** : Press when performing playback on a second VCR unit.

**VIDEO** : Press when performing playback on a TV camera or VCR connected to VIDEO INPUT jack on the front panel.

**TV/SAT** : Press to watch TV broadcasts from the TV tuner connected to the rear panel TV/SAT IN jacks.

**LD** : Press when performing playback on an LD player.

**TAPE 1** : Press when performing playback on a cassette deck.

**TAPE 2 MONITOR** : Press when performing playback on a second cassette deck and when monitoring recording.

**PHONO** : Press when playing records on a turntable.

**TUNER** : Press when listening to radio broadcasts.

**CD** : Press when playing compact discs on a CD player.

## ⑧ AC-3 button\*\*/indicator

Switches AC-3 (Dolby Surround AC-3) on and off. (When the input selector is set to a source other than LD or TV/SAT, it does not operate.)

No sound will be heard if you turn on this switch when playing an LD that does not use the AC-3 format.

\*\* Setting is memorized separately for each input selector button.

## FRONT PANEL FACILITIES

### ⑨ MULTI-JOG

Use during tuner operation to select frequencies and station numbers. During GUI operation, use to move the on-screen cursor.

### ⑩ GUI ENTER button (GUI operation)

Press to execute an operation selected with the MULTI-JOG.

### ⑪ INPUT ATT button

Press on, and audio input sensitivity is attenuated (-10 dB) to prevent clipping due to excessively high input levels. Switch this on if the overload indicator in the display section lights during playback. When you switch it on, the ATT indicator lights.

#### NOTE:

Operates only when a DSP mode other than AC-3 is on.

### ⑫ GUI MODE button

Switches GUI MODE on and off.

### ⑬ MASTER VOLUME control

Use it to simultaneously adjust the sound volume from the front, center, and rear speakers.

### ⑭ SLEEP button/indicator

Activates the SLEEP timer. The length changes in the following manner each time the button is pressed:

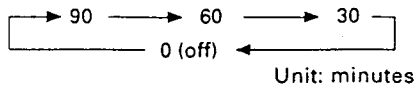

### ⑮ PHONES jack

Connect the plug on your headphones to this jack. Set SPEAKERS A and B switches to off if you want to cut the sound from the speakers and listen to it only through the headphones.

### ⑯ VIDEO INPUT jacks

VIDEO components such as a VCR or TV camera, etc. can be connected.

### ⑰ DIRECT button\*\*/indicator

Press this to listen to source sound without passing the audio signal through sound quality and balance adjusting circuitry. DSP, super bass, INPUT ATT, rear and center speakers are automatically switched off.

### ⑱ Display section

See page 15.

### ⑲ TUNING MODE buttons

#### FM/AM button:

Use this to switch between FM and AM frequency band reception.

#### MPX MODE button:

Use to select the auto stereo mode or monaural mode when listening to FM broadcasts. The monaural mode has been selected when the MONO indicator in the display section is lit.

#### Auto stereo mode

Normally, leave in this mode for reception. When a stereo FM broadcast is received, it will be automatically reproduced in stereo.

#### Monaural mode

When receiving distant stations or stations with weak broadcast signals, the input signal may be weak, thus resulting in increased noise during FM stereo broadcasts. In this event, setting the receiver to the monaural mode will reduce the noise. In this case, however, FM stereo broadcasts will be reproduced in monaural sound.

#### NOTE:

This button has no effect on reception of AM broadcasts.

#### MEMORY button:

Press this button to switch to the frequency preset mode.

#### SELECT button:

Press this button to switch to the station mode. Then you can turn the multi-jog to select a station.

### ⑳ DSP OFF button\*\*

Switches DSP (㉒ DSP MODE, ㉑ DOLBY PRO-LOGIC, ㉓ AC-3) off.

### ㉑ DOLBY\* PRO-LOGIC button\*\*

Switches DOLBY PRO-LOGIC SURROUND on and off.

### ㉒ DSP MODE button\*\*

Each time you press it, the mode and the display indications change as follows:

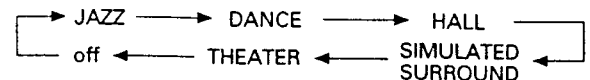

### ㉓ SUPER BASS button\*\*

Press this button when you want to boost the bass.

### ㉔ BASS control

Use to adjust the low-frequency level. Turn clockwise to boost bass, and counterclockwise to attenuate bass.

### ㉕ TREBLE control

Use to adjust the high-frequency level. Turn clockwise to boost treble, and counterclockwise to attenuate treble.

### ㉖ SUPER BASS control

Use to adjust the bass boost level when the SUPER BASS button is set to on.

\*\* Setting is memorized separately for each input selector button.

\*

Manufactured under license from Dolby Laboratories Licensing Corporation. Additionally licensed under Canadian patent number 1,037,877. "Dolby", "AC-3", "Pro Logic" and the double-D symbol are trademarks of Dolby Laboratories Licensing Corporation.

Fabriqué sous licence de Dolby Laboratories Licensing Corporation et sous le brevet suivant: Canada 1,037,877. DOLBY, AC-3, PRO LOGIC et le symbole double-D, sont des marques de Dolby Laboratories Licensing Corporation.

## DISPLAY SECTION

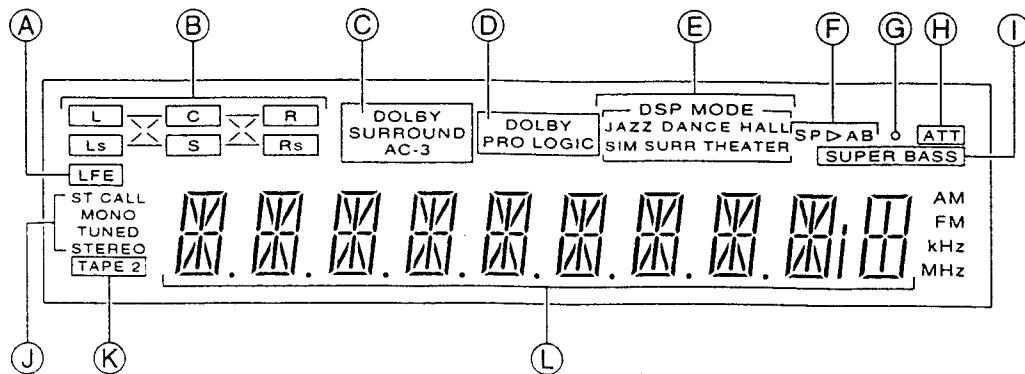
**A LFE indicator**

During Dolby AC-3 mode operation, if the LFE (Low Frequency Effect) channel is set in the program source, "LFE" lights, and if there is an LFE signal, a frame " " lights.

**B Dolby AC-3 channel indicator**

During Dolby AC-3 mode operation, the channel set in the program source is indicated.

**C DOLBY SURROUND AC-3 indicator****D DOLBY PRO LOGIC indicator****E DSP MODE indicators****F SP (SPEAKERS) A, B indicators**

Shows which speaker system (or systems) are switched on.

**G Overload indicator**

This lights when input signal level is excessive.  
If it lights during playback, press the INPUT ATT button on, and the ATT indicator lights.  
Operates only when a DSP mode other than AC-3 is on.

**H ATT indicator**

This lights when the INPUT ATT button is on.

**I SUPER BASS indicator**

This lights when the SUPER BASS button is on.

**J Tuning indicators****ST (STATION) CALL**

: Press the SELECT button to switch to the station mode and this indicator lights.

**MONO** : Lights up when the FM MONO mode is selected with the MPX MODE button.

**TUNED** : Lights up when a station is tuned.

**STEREO** : Lights up when a stereo FM broadcast is being received.

**K TAPE 2 indicator**

Lights up when the input selector is set to TAPE 2 MONITOR on.

**L Character display**

## OPERATING THE TUNER

Press the POWER switch to the ON position.  
Select TUNER with the input selector button.  
Be sure to turn the TAPE 2 MONITOR button off when listening to AM or FM broadcasts.  
Switch on the SPEAKERS button corresponding to the speakers you wish to use.

### FM auto stereo reception and monaural reception

Each time you press the MPX MODE button, the MONO indicator in the display section lights or goes out.

- If an FM stereo broadcast is received when the MONO indicator is out, the STEREO indicator lights and sound is in stereo.
- If an FM stereo broadcast is received when the MONO indicator is lit, the sound will be monaural. If there is interference during stereo mode reception, switch to mono. The sound will become monaural but interference will be reduced.

## TUNING INTO STATIONS

Turn the MULTI-JOG and the tuning frequency changes.  
(Switch off when the GUI MODE button is on.)  
Turning in a clockwise direction raises the frequency, while turning in a counterclockwise direction lowers the frequency.

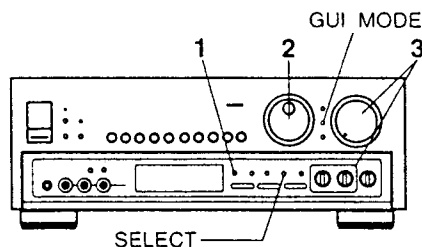

1. Use the FM/AM button to select either FM or AM.  
When the "ST CALL" indicator is lit in the display, press the SELECT button to switch it off.
2. Turn the MULTI-JOG until you reach the frequency of a desired station.  
When a station is received, the TUNED indicator will light up.

#### NOTE:

The TUNED indicator may not light with broadcasts received over long distances, or when the broadcast signals are extremely weak.

3. Adjust the volume and tone as desired.

### Auto tuning

Auto tuning is convenient when you do not remember the frequency of a desired station, or when you wish to find stations that you do not normally listen to.

Operate by remote control. (Refer to page 23.)

You can also perform Auto Tuning using GUI. (Refer to page 25.)

## FREQUENCY PRESETTING

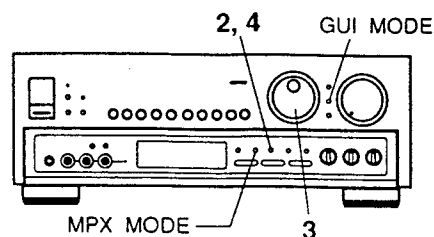

Switch off when the GUI MODE button is on.

1. Tune into the desired station.  
See the section "TUNING INTO STATIONS".  
In addition to station frequencies, the MPX MODE (auto stereo mode or monaural mode) can also be preset (FM only).
2. Press the MEMORY button.  
The station (channel) number flashes in the display. (Memory mode.)
3. Turn the MULTI-JOG to select the station (channel) you want to memorize.
4. Press the MEMORY button.
  - The station (channel) number lights in the display, indicating that it has been memorized.
  - If you do not press the MEMORY button within about five seconds after selecting a station, the memory mode is canceled.
5. Repeat steps 1 to 4 to preset additional stations.  
A total of 30 AM and FM stations may be preset. When you store a new preset, it takes the place of the previously stored station (if any).

You can also preset using GUI. (Refer to page 25.)

## LISTENING TO BROADCASTS USING PRESET TUNING

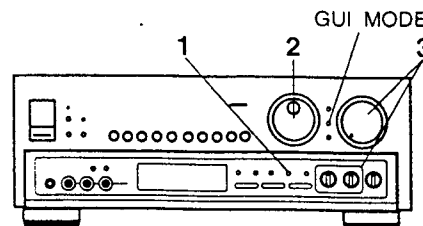

Switch off when the GUI MODE button is on.

1. Press the SELECT button.  
The "ST CALL" indicator lights in the display and the mode switches to station call.
2. Turn the MULTI-JOG to select a station.
3. Adjust the volume and tone as desired.

When operating by remote control, press the ST +/- buttons to select a memorized station. (Refer to page 23.)

With GUI, you can also select preset channels. (Refer to page 25.)



**NOTE:**

Even if the receiver's power cord is unplugged, data remains in memory for several days. If the contents of the memory are erased, preset once more.

**Last station memory**

When the POWER switch is pressed to turn the power on, the last station received before the power was previously turned off will be tuned in again. When the power is ON, if the FM/AM button is pressed, the last station received before the FM/AM button was previously pressed will be tuned in again.

**RECEIVING FM SIMULCAST TV PROGRAMS**

By combining a TV set with this receiver, you can receive FM simulcast TV programs (stereo TV sound transmitted from an FM radio station) while viewing the video portion on your TV.

1. Select the desired TV program with the TV set.
2. Tune in the desired FM simulcast TV program on the receiver.
3. Adjust the volume and tone controls as desired.

**OPERATING THE AUDIO/VIDEO COMPONENTS**

Press the power switch to the ON position, and turn on the power to the other components you wish to use (for example, TV, VCR, cassette deck, etc.).

**PLAYBACK**

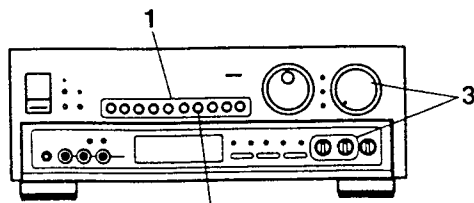

TAPE 2 MONITOR

1. Use the input selector buttons to select the desired program source.  
If you select a music source other than TAPE 2, switch off the TAPE 2 MONITOR.
2. Operate the appropriate audio/video component to playback the program source.  
For a video source, switch the TV connected to this unit to the video input mode.
3. Adjust the volume and tone controls as desired.  
Refer to page 19 for details concerning surround operation. (Surround operation is also possible with GUI. Refer to page 24.)

Program Source	Input selector
To watch a video cassette tape on the VCR connected to VCR 1 jacks.	VCR 1
To watch a video cassette tape on the VCR connected to VCR 2 jacks.	VCR 2
To watch a VCR connected to VIDEO INPUT jacks on front panel.	VIDEO
To watch the TV picture from a TV tuner connected to the TV/SAT jacks.	TV/SAT
To watch a LaserDisc.	LD
To listen to a tape on the cassette deck connected to TAPE 1 jacks.	TAPE 1
To listen to a tape on the cassette deck connected to TAPE 2 MONITOR jacks.	TAPE 2 MONITOR
To listen to a record.	PHONO
To listen to a compact disc.	CD

## RECORDING WITH A CASSETTE DECK

### RECORDING WITH TAPE 1

If the TAPE 2 MONITOR button is on, press to turn off.

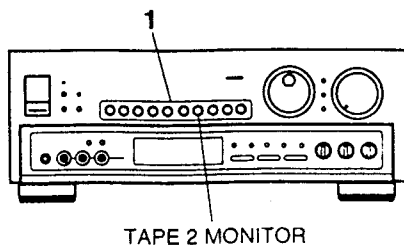

1. **Select the source you want to record from with the input selector buttons.**  
When recording AM or FM broadcasts, select a preset station using the MULTI-JOG. If the desired station has not been preset, tune in the station.
2. **Start recording on TAPE 1 cassette deck.**
3. **Play the desired program source (record, compact disc, etc.).**  
The volume, balance and tone controls have no effect on the recording.

### RECORDING WITH TAPE 2

1. **Select the source you want to record from with the input selector buttons.**
2. **Start recording on the TAPE 2 cassette deck.**
3. **Play the desired program source (record, compact disc, etc.).**  
The volume, balance and tone controls have no effect on the recording.

### USING VCR 1, VCR 2 FOR AUDIO RECORDING

The audio signal output from the VCR 1 and VCR 2 AUDIO OUT jacks is the same as that output from the TAPE 1 REC jacks, so you can record using the same procedure as for recording with TAPE 1.

### COPYING TAPES

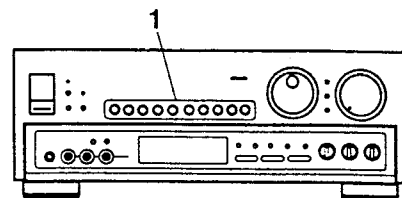

The following operations concern TAPE 1 to TAPE 2 copying.

1. **Press the TAPE 1 input selector button.**
2. **Load the TAPE 1 cassette deck with a tape to playback.**
3. **Load the TAPE 2 cassette deck with a tape to record to.**
4. **Start recording on the TAPE 2 cassette deck.**
5. **Start playback on the TAPE 1 cassette deck.**

The following operations concern TAPE 2 to TAPE 1 copying.

1. **Select a source other than TAPE 1 with the input selector buttons.**
2. **Press the TAPE 2 MONITOR button to turn it on.**
3. **Load the TAPE 2 cassette deck with a tape to playback.**
4. **Load the TAPE 1 cassette deck with a tape to record to.**
5. **Start recording on the TAPE 1 cassette deck.**
6. **Start playback on the TAPE 2 cassette deck.**

#### Tape monitoring

When recording is performed on a cassette deck equipped with a monitoring function, the recorded sound can be monitored through the speaker system by pressing the TAPE 2 MONITOR button to ON.

## VIDEO RECORDING

Refer to the connection procedures on pages 8 to 10 and refer to the VCR's Operating Instructions regarding proper operation procedures. Recording can be performed on both VCR 1 and VCR 2.

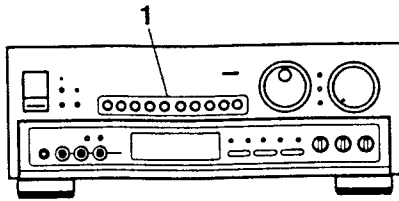

**1. Select the source you want to record from with the input selector buttons.**

- When recording from a LaserDisc on VCR 1 or VCR 2 → LD
- When recording from the TV tuner on VCR 1 or VCR 2 → TV/SAT
- When recording from VCR 1 on VCR 2 → VCR 1
- When recording from VCR 2 on VCR 1 → VCR 2
- When recording on VCR 1 or VCR 2 from a component connected to the front panel VIDEO INPUT jacks → VIDEO

**2. Start recording on the VCR.**

For VCR, select a line input (external input).

**3. Start playback on the component selected with the input selector buttons.**

The volume, balance and tone controls have no effect on the recording.

**NOTE:**

When recording with VCR 1, be sure the input selector is set to a position other than VCR 1. When recording with VCR 2, be sure the input selector is set to a position other than VCR 2.

GUI operation enables easy copying from a LaserDisc to VCR 1 (or 2), and copying between VCR 1 and VCR 2. (Refer to page 28.)

## SURROUND EFFECT

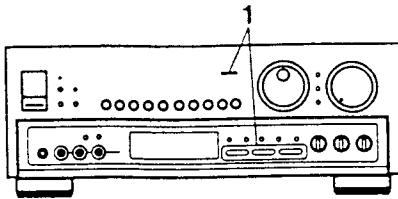

**1. Select the desired mode with the DOLBY PRO-LOGIC button, DSP MODE button and AC-3 button.**

The DSP MODE changes in sequence each time the DSP MODE button is pressed. (The DSP MODE indicator lights.)

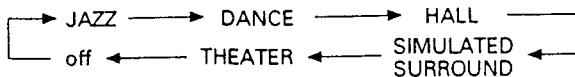

- Press the DSP OFF button to switch the DSP off.
- If rear speakers are not selected during SPEAKER MODE setting (page 29), pressing the DOLBY PRO-LOGIC button selects DOLBY 3CH LOGIC.

**2. Adjust levels to achieve a correct surround sound reproduction.**

This is done using GUI (page 24). For details concerning how to perform level adjustment, refer to page 30.

You can set this unit to match the requirements and specifications of your stereo system's speakers (whether or not center speaker(s), rear speakers or a sub-woofer are used, speaker size, etc.) to assure optimum sound quality. Before using, perform settings in the SPEAKER MODE (refer to page 29).

**NOTE:**

This unit does not feature conventional switching between NORMAL/WIDE/PHANTOM center modes.

## REMOTE CONTROL OPERATION

### PUTTING BATTERIES INTO THE REMOTE CONTROL UNIT

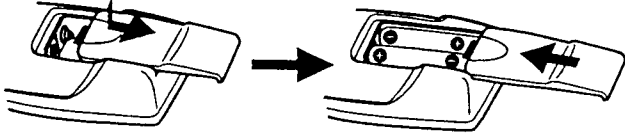

1. Open the battery compartment cover on the rear of the remote control unit. The cover should open easily if you slide it in the direction of the arrow while pressing on it with your thumb.
2. Press the RESET button in the center hole of the battery compartment.
3. Take out the two supplied batteries size "AA" (IEC R6P), and insert them into the battery compartment in accordance with the indications in the compartment.
4. Close the cover of the battery compartment.

**Incorrect use of batteries may lead to leakage or rupture. Always be sure to follow these guidelines:**

**A:**

Always insert batteries into the battery compartment correctly matching the positive  $\oplus$  and negative  $\ominus$  polarities, as indicated inside the compartment.

**B:**

Never mix new and used batteries.

**C:**

Batteries of the same size may have different voltages, depending on their type. Do not mix different types of batteries.

### REMOTE CONTROL RANGE

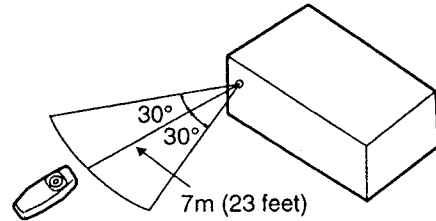

When operating the remote control unit, point the front of the unit at the front panel of the receiver. The remote control unit may be used within a range of about 7 meters (23 feet) from the remote sensor, within angles of up to about 30 degrees. Performance of the remote control unit is adversely affected in the presence of a strong fluorescent light. Keep such lights away, especially from the sensor window.

#### Battery Replacement

As battery power runs down, the range over which the remote control unit can operate decreases. Also, ONE TOUCH OPERATION and other buttons light less brightly.

When the range becomes too short, change the batteries.

**RECEIVER CONTROL BUTTONS**

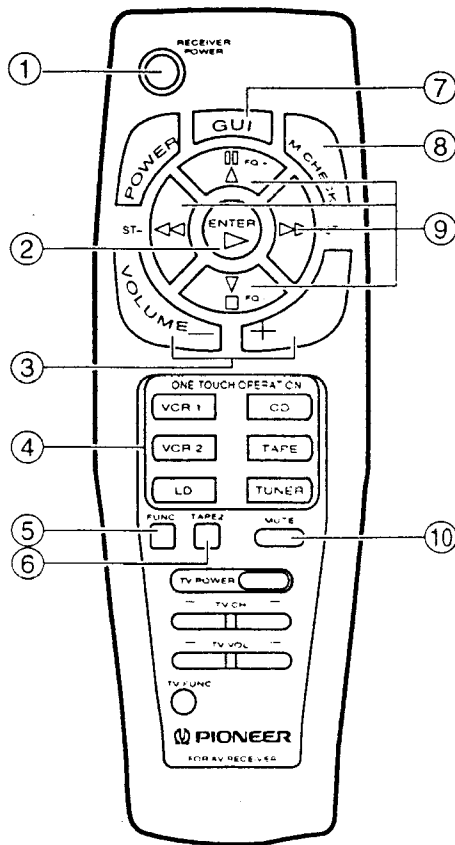

**1 RECEIVER POWER button**

Switches the receiver power between ON and STANDBY.

**2 ENTER button**

When GUI is on, press to execute an operation selected with the Select/Adjust buttons.

**3 VOLUME +, - buttons**

Adjusts the overall volume.

**4 ONE TOUCH OPERATION buttons**

VCR 1/2, CD, LD, TAPE:

Pressing these buttons automatically calls up "ONE TOUCH OPERATION SET UP" settings, made using GUI (page 33).

**TUNER:**

This switches power to the TUNER ON and starts reception of the last memorized station.

Also, if power to this unit is OFF, it is switched ON and operation automatically switches to the selected function. When you press any of the ONE TOUCH OPERATION buttons, the GUI MODE switches off.

**5 FUNC. (function) button**

Press to select the receiver input.

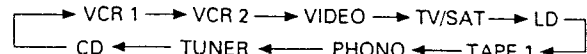

**6 TAPE 2 (TAPE 2 MONITOR) button**

Switches TAPE 2 MONITOR on and off.

**7 GUI button**

Switches GUI MODE on and off.

When the GUI mode is on, the 9 Select/Adjust buttons (Δ, ▷, ▽, ◁) light.

**8 M.CHECK (Mode check) button**

Indicates whether the GUI MODE is on or off.

When it is on, Δ, ▷, ▽, ◁ light. When it is off, a 4 ONE TOUCH OPERATION button lights to indicate the current function.

If you press the button again while it is lit, remote control functions change. When the remote control is in the GUI mode, the 9 Select/Adjust buttons (Δ, ▷, ▽, ◁) light.

**9 Select/Adjust buttons (Δ, ▷, ▽, ◁)**

When the GUI mode is on, Δ, ▷, ▽ and ◁ light.

When using the GUI function with the on-screen display, use for such operations as selection and adjustments (by moving the cursor).

When the GUI mode is off, use to operate other components.

**10 MUTE button**

Used to temporarily mute the sound. When it's in the on position, the indicator on the MASTER VOLUME knob flashes. The volume is restored when pressed again.

**OPERATING OTHER COMPONENTS**

**REMOTE CONTROLLING OF ANY OTHER OF YOUR AUDIO-VISUAL COMPONENTS VIA THIS UNIT REQUIRES:**

All components must be remote controllable (have a sensor window on the front panel) to receive a direct command from this unit, upon successful learning of those commands by this programmable unit.

**When operating components other than the receiver:**

1. Press the ONE TOUCH OPERATION button for the component you want to operate.
2. Press the operation button.

**NOTE:**

Components that could not originally be operated by remote control cannot be controlled by this unit's remote control.

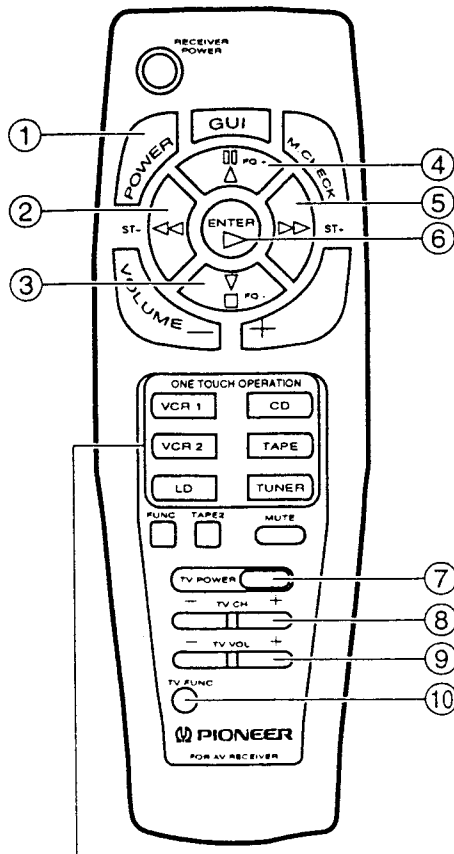

ONE TOUCH OPERATION buttons switch between each of the functions.

**TV operation**

- ① **TV POWER button:**  
Switches the power of the TV ON/OFF.
- ② **TV CH (channel) +, - button:**  
Switches TV channels in order.
- ③ **TV VOL (volume) +, - button:**  
Raises (+) and lowers (-) the volume.
- ④ **TV.FUNC. (function) button:**  
Used to change the TV FUNCTION.  
TV FUNC. button cannot be used with some PIONEER TVs.

**VCR 1/VCR 2 operation**

- ① **POWER button:**  
Switches VCR power ON/OFF.
- ② **◀◀ (REW) button:**  
Rewinds the tape and allows picture search.
- ③ **■ (STOP) button:**  
Stops the tape transport.
- ④ **⏸ (PAUSE/STILL) button:**  
Sets pause and still picture.
- ⑤ **▶▶ (FF) button:**  
Rapidly advances the tape and allows picture search.
- ⑥ **▶ (PLAY) button:**  
Selects playback.

**LD player operation**

- ① **POWER button:**  
Switches LD player power ON/OFF.
- ② **◀◀ (SCAN/CHAPTER SEARCH) button:**  
Pressing quickly once takes you to the start of the chapter currently playing. Each time you press it, you move back to the start of the previous chapter. Continue pressing for fast reverse.
- ③ **■ (STOP) button:**  
Playback is stopped when pressed once.  
With some LD players, pressing the button twice may open the disc tray.
- ④ **⏸ (PAUSE) button:**  
Video and audio are stopped and playback is paused.
- ⑤ **▶▶ (SCAN/CHAPTER SEARCH) button:**  
Pressing quickly once takes you to the start of the next chapter. Each time you press it, you move ahead to the start of the next chapter. Continue pressing for fast forward.
- ⑥ **▶ (PLAY) button:**  
Selects playback.

**CD player operation**

- ① **POWER button:**  
Switches CD player power ON/OFF.
- ② **◀◀ (MANUAL/TRACK SEARCH) button:**  
Pressing quickly once takes you to the start of the track currently playing. Each time you press it, you move back to the start of the previous track. Continue pressing for reverse search.  
Pressing the ◀◀ button while pressing the ■ button takes you to the previous disc. (With a file-type CD player.)
- ③ **■ (STOP) button:**  
Stops playback.
- ④ **⏸ (PAUSE) button:**  
Pauses playback.
- ⑤ **▶▶ (MANUAL/TRACK SEARCH) button:**  
Pressing quickly once takes you to the start of the next track. Each time you press it, you move ahead to the start of the next track. Continue pressing for forward search.  
Pressing the ▶▶ button while pressing the ■ button takes you to the next disc. (With a file-type CD player.)
- ⑥ **▶ (PLAY) button:**  
Selects playback.

**TAPE operation**

- ① **POWER button:**  
Switches cassette deck power ON/OFF.
- ② **◀◀ (FF) button:**  
Rapidly advances the tape in the direction of the arrow.
- ③ **■ (STOP) button:**  
Stops the tape transport.
- ④ **⏸ (PAUSE) button:**  
Temporarily stops tape transport. Press again to resume tape transport.
- ⑤ **▶▶ (FF) button:**  
Rapidly advances the tape in the direction of the arrow.
- ⑥ **▶ (PLAY) button:**  
Selects playback.

**NOTE:**

*On a Pioneer double deck, you can operate Deck II.*

**Tuner operation**

- ② **ST - (Station Down) button:**  
Used for recalling memorized stations.
- ③ **FQ - (Frequency Down) button:**  
Shifts the frequency down.
- ④ **FQ + (Frequency Up) button:**  
Shifts the frequency up.
- ⑤ **ST + (Station Up) button:**  
Used for recalling memorized stations.
- ⑥ **Band button:**  
Switches the FM and AM bands in turn.

**Auto tuning:**

Press FQ + (up) or - (down) button until the frequency starts to change, then release it. The tuner will automatically search for a broadcasting station and stops when one is found, and the TUNED indicator lights up. To search for another station, press again.

**Manual tuning:**

Press FQ + (up) or - (down) button and release quickly. The tuning frequency will change by one step each time the button is pressed. Press as many times as necessary to tune in the desired station. The TUNED indicator lights up when the station is tuned in best.

- If you keep the FQ (up/down) button depressed after the frequency has began to change, the reception frequency changes continuously, and stops when the button is released.

**NOTE:**

*When AUTO TUNING is in use, reception may not be possible over long distances or when signals are weak. At these times MANUAL TUNING is recommended.*

## GUI

GUI (Graphic User Interface) lets you use the TV screen to operate the system.

- Press the GUI MODE button on this unit or the GUI button on the remote control and operation indications for the currently selected function are displayed on the TV screen.
- To operate, use the  $\Delta$ ,  $\triangleright$ ,  $\nabla$ ,  $\triangleleft$  buttons on the remote control (they light up when the GUI mode is on) or the MULTI-JOG on this unit to move the cursor (the hand shaped mark) displayed on the TV screen. When the cursor is on the button you want to operate, press the GUI ENTER button.

- When the operating instructions say "Press the button", this means move the cursor to the desired button and press the GUI ENTER button.

### NOTE:

- If you do not perform any of the operations above within 10 ~ 30 seconds, the GUI display is canceled.
- <Multi-voltage model only>  
Set the rear panel PAL/NTSC switch to match your TV's color system. The screen will be unclear if the color system does not match.

## RECEIVER CONTROL BUTTONS

- The buttons in the following explanation are the receiver operation button indications common to all function displays. (The illustration shows LD operation indications.)

(Figure 1: Main Menu display)

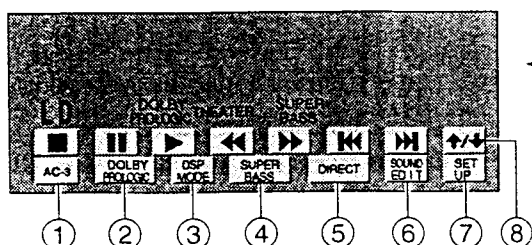

### 1 AC-3:

Switches DOLBY SURROUND AC-3 on/off.

When on, "AC-3" is displayed on the right of the function indications. (When the input selector is set to a source other than LD or TV/SAT, it does not operate. Also, when TAPE 2 is on, it does not operate.)

### 2 DOLBY PRO-LOGIC:

Switches DOLBY PRO-LOGIC on/off.

When on, "DOLBY PRO-LOGIC" is displayed to the right of the function indications.

### 3 DSP MODE:

Switches between the five DSP modes as follows:

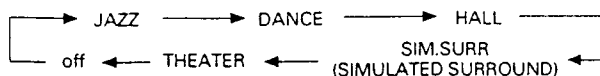

The selected mode is displayed to the right of the function indications.

### 4 SUPER BASS:

Switches SUPER BASS on/off.

When on, "SUPER BASS" is displayed on the right of the function indications.

### 5 DIRECT:

Press this to listen to source sound without passing the audio signal through sound quality and balance adjusting circuitry. The surround mode, rear and center speakers are automatically switched off.

### 6 SOUND EDIT:

Press to make adjustments such as level setting for the currently selected DSP mode, DOLBY SURROUND AC-3 or DOLBY PRO-LOGIC.

When you press this button, the display changes to SOUND EDIT indications. (Refer to page 30.)

(Figure 2: Sub Menu display)

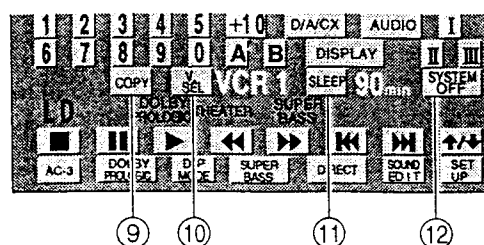

### 7 SET UP:

Press this button and the display changes to the SET UP MENU. (Refer to pages 31 - 33.)

### 8 Display change button:

Switches between Main Menu display (Figure 1) and Sub Menu display (Figure 2).

### 9 COPY:

Press to copy from a LaserDisc to a VCR, or to copy between VCR 1 and VCR 2.

When you press this button, the display changes to COPY indications. (This button is displayed only when the function is LD, VCR 1 or VCR 2. Refer to page 28.)

### 10 V.SEL (VIDEO SIGNAL SELECTOR):

This switches only the video signal in sequence, leaving the sound unchanged. (Refer to page 28.)

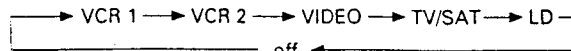

### 11 SLEEP:

This operates the sleep timer. Move the cursor to this button, and each time you press the GUI ENTER button, timer settings change as follows:

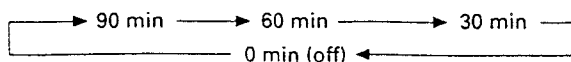

### 12 SYSTEM OFF:

Switches power to this unit, the TV and the currently selected function off.

### NOTE:

When you press the SYSTEM OFF button, power to components not made by Pioneer switches on if power to these components was already switched off.



## Calling up the tuner display.

1. Press the TUNER button of the input selector.
  2. Press the GUI MODE button on this unit or the GUI button on the remote control.
- TUNER operation indications are displayed.

(Main Menu display)

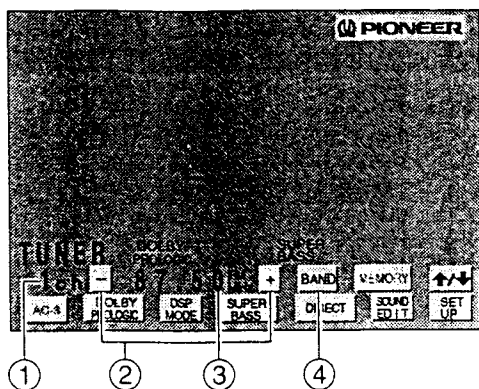

(Sub Menu display)

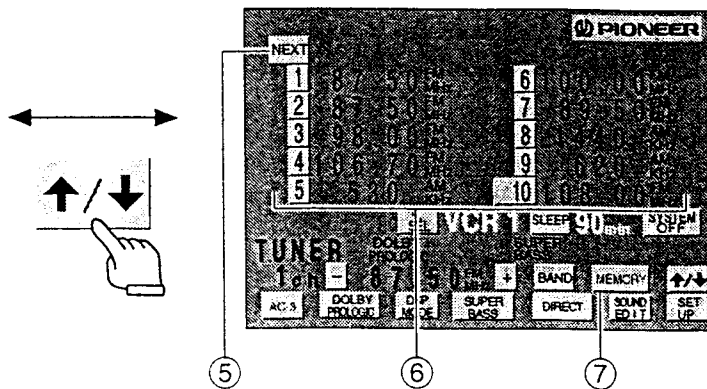

### ① Channel indication:

Indicates the current channel.

### ② -, + buttons:

Use to raise or lower the frequency.

### ③ Frequency indication:

Indicates the current frequency.

### ④ BAND button:

Switches between FM/AM. The band changes each time you press this button and is displayed next to the frequency indication.

### ⑤ NEXT button:

Switches between channel lists. There are a total of thirty channels, from 1 to 30, displayed 10 at a time on three lists which change each time you press the button as follows.

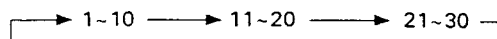

### ⑥ Channel list:

Frequencies memorized in each channel are displayed. Press a number button and that channel's frequency is received.

### ⑦ MEMORY button:

Use to memorize stations.

You can only press this button when a channel list is displayed (Sub Menu display).

## MANUAL/AUTO TUNING

1. Move the cursor to BAND, and select FM or AM.  
The band changes each time you press the GUI ENTER button.
2. Move the cursor to + or - and press the GUI ENTER button to raise or lower the frequency as desired.

### ● One Step Tuning:

Press the GUI ENTER button and release quickly. The frequency will change by one step each time the button is pressed. Press as many times as necessary to tune in the desired station.

### ● Auto Tuning:

Press the GUI ENTER button until the frequency starts to change (about 1 sec.), then release it. The tuner automatically searches for a broadcasting station and stops when one is found.

### NOTE:

When the signal level is too weak for reception, the unit cannot perform Auto tuning. In this case, change to Manual tuning.

### ● High Speed Manual Tuning:

Keep the GUI ENTER button pressed. The frequency changes continuously and stops when the button is released.

## PRESET TUNING

You can preset up to 30 FM/AM stations for easy recall.

### FREQUENCY PRESETTING

1. Press **↑/↓** to switch to the Sub Menu display.  
(The channel list is displayed.)
2. Tune in the desired station.  
Refer to "MANUAL/AUTO TUNING" procedures.  
In addition to station frequencies, the MPX MODE can also be preset (FM only).  
Switch to the MPX MODE using the MPX MODE button on this unit. (No indications are displayed.)
3. Press the **MEMORY** button.  
Channel indications "--" flash.
4. Select the channel you want to memorize from the channel list and press the **GUI ENTER** button.  
This memorizes the frequency.  
To memorize other stations, repeat steps 2 through 4.

## <VCR 1/VCR 2>

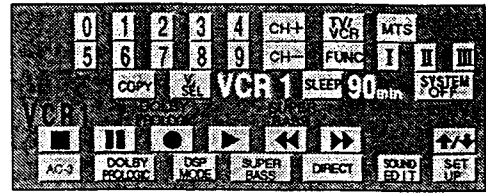
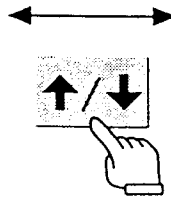
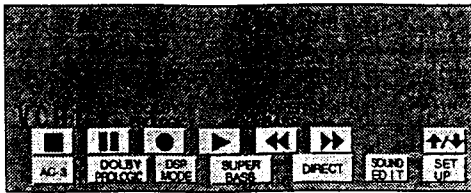

- : Stops tape transport.
- || : Sets pause and still picture.
- : Selects the recording mode.
- ▶ : Starts playback.
- ◀◀ : Rewinds the tape.
- ▶▶ : Rapidly advances the tape.

- 0 ~ 9 : Use to call up channels.
- CH + : Shifts channels in ascending order.
- CH - : Shifts channels in descending order.
- TV/VCR : This button can be used only for VCRs with a TV/VCR selector. Toggles the antenna output between TV and VCR.
- FUNC : Switches the input selector functions.
- MTS : Selects the reception mode for multi-channel TV sound.
- I / II / III : Using the REMOTE SET UP learning function (page 32), use to memorize commands.

**NOTE:**

Fast-forwarding or rewinding during playback may interfere with GUI display.

## <TAPE>

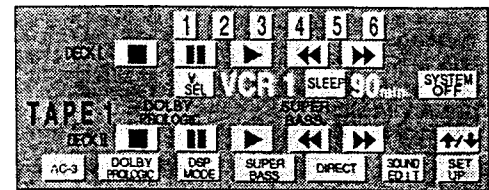
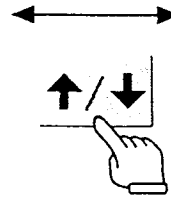
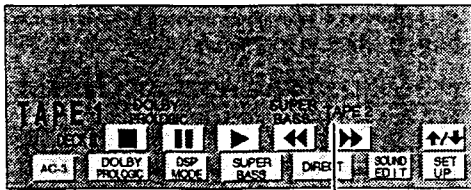

TAPE 2 MONITOR indicator

**[DECK II]**

- : Stops playback.
- || : Temporarily stops tape transport.
- ▶ : Selects playback.
- ◀◀ : Rapidly advances the tape in the direction of the arrow.
- ▶▶ : Rapidly advances the tape in the direction of the arrow.
- TAPE 2 : Displayed when TAPE 2 MONITOR is on.

**[DECK I]**

- : Stops playback.
- || : Temporarily stops tape transport.
- ▶ : Selects playback.
- ◀◀ : Rapidly advances the tape in the direction of the arrow.
- ▶▶ : Rapidly advances the tape in the direction of the arrow.
- 1 ~ 6 : Selects the cassette No. (1 to 6) for multi-cassette changer.

When using a single cassette deck, select DECK II.

## <TV>

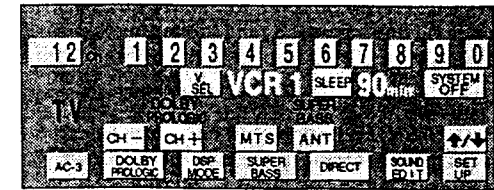
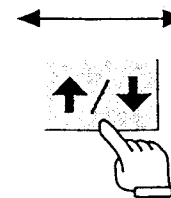
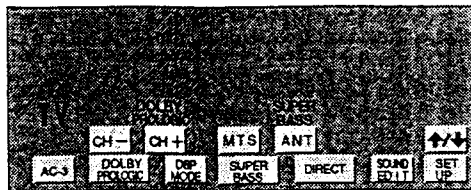

- CH - : Shifts channels in descending order.
- CH + : Shifts channels in ascending order.
- MTS : Selects the reception mode for multi-channel TV sound.
- ANT : Press to switch between ANTENNA-A and ANTENNA-B when you wish to watch TV.

**CHANNEL 1 ~ 9, 0**

- : Used to call up channels. For example, to receive channel "23", press 2 and then 3. For channels 1 through 9, press the number and wait for about 2 seconds.

<CD>

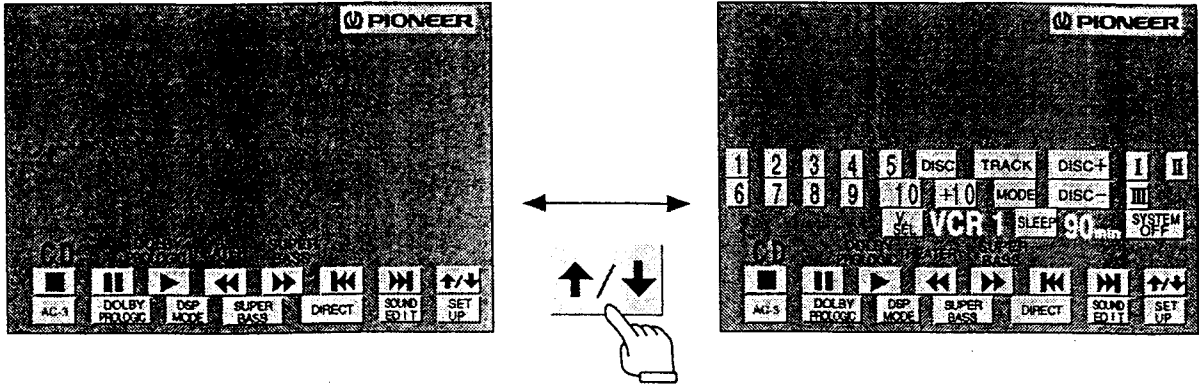

- : Stops playback.
- || : Pauses playback.
- ▶ : Selects playback.
- ◀◀ : Selects fast backward.
- ▶▶ : Selects fast forward.
- ◀◀▶▶ : Returns to the beginning of the track currently playing.
- ▶▶▶▶ : Advances to the next track.

- 1 ~ 10 : For direct selection of a track or programming of tracks.
- +10 : Use when selecting a track number higher than 10. For example, to select 21, press the +10 button twice and then the 1 button.
- DISC : This button cannot be used with some CD players. Before selecting a disc number button, select this button first.
- TRACK : Before selecting a track number button, select this button first.
- MODE : Use this button to switch between SINGLE and ALL modes when using a File-type CD player. To play only a single disc select SINGLE. For search and continuous play of all discs select ALL.
- DISC + : Use to select a disc number.
- DISC - : Use to select a disc of the file-type CD player.
- I / II / III : Using the REMOTE SET UP learning function (p. 32), use to memorize commands.

<LD>

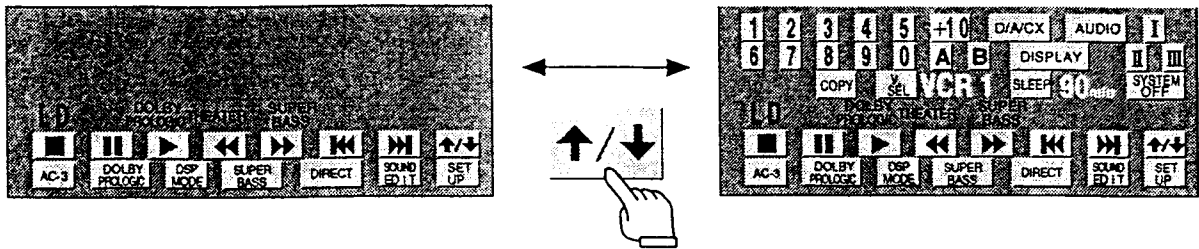

- : Playback is stopped when selected once. With some LD players, pressing the button twice may open the disc tray.
- || : Video and audio are stopped and playback is paused.
- ▶ : Selects playback.
- ◀◀ : Selects fast backward.
- ▶▶ : Selects fast forward.
- ◀◀▶▶ : Searches for the start of the chapter currently playing.
- ▶▶▶▶ : Searches for the start of the next chapter.

- 1 ~ 10 : For direct selection of a chapter.
- +10 : Use to input such information as chapter numbers higher than 10.
- D/A/CX : Use to switch between LD digital/analog sound and the CX system.
- A : Selects playback of LD disc to side A.
- B : Selects playback of LD disc to side B.
- AUDIO : Switches speakers between STEREO, L and R.
- DISPLAY : Switches TV screen display of chapter, frame/time number on/off.
- I / II / III : Using the REMOTE SET UP learning function (p. 32), use to memorize commands.

## COPY OPERATION (GUI OPERATION)

ISC Intelligent System Control

- LD → VCR 1/2 and VCR 1 ↔ VCR 2 copying is possible.
- For VCR, select a line input (external input).

### LD → VCR 1 (VCR 2) Copying

1. Select LD with the FUNC. button and press  $\uparrow/\downarrow$  to switch to the Sub Menu display. LD function indications are displayed.

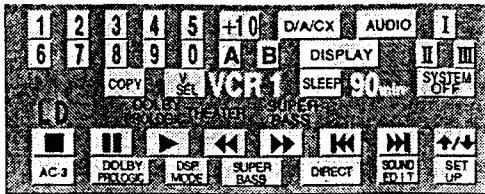

2. Press the COPY button. COPY indications are displayed.

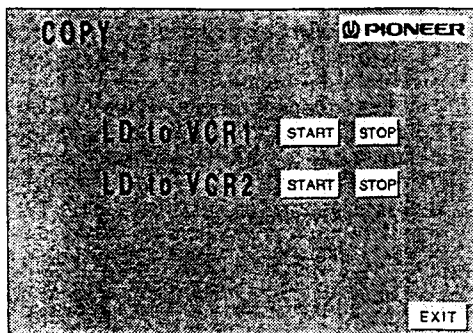

3. Select the component you are using to copy (VCR 1 or VCR 2), and press START. The LD player starts playing and recording begins on the VCR. To stop, press the STOP button.

### VCR 1 → VCR 2 or VCR 2 → VCR 1 Copying

(Example: VCR 1 → VCR 2)

1. Select VCR 1 with the FUNC. button and press  $\uparrow/\downarrow$  to switch to the Sub Menu display. VCR 1 function indications are displayed.

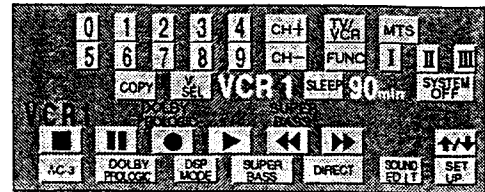

2. Press the COPY button. COPY indications are displayed.

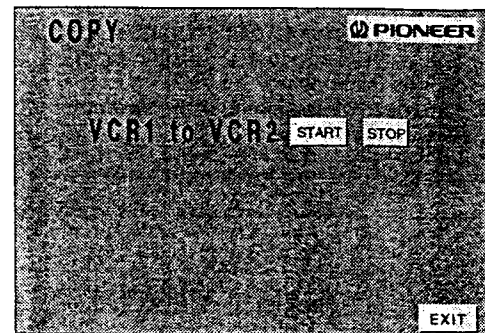

3. Press START. VCR 1 starts playing back and recording starts on VCR 2. To stop, press the STOP button.

## USING THE VIDEO SIGNAL SELECTOR (GUI OPERATION)

This function can be used to allow you to listen to the playback sound while changing the video image only, thus allowing you to playback and record video images different from the playback sound source.

1. Select the component you want to listen to with the FUNC. button. When listening to (or recording) AM or FM broadcasts, select a preset station. If the desired station has not been preset, tune in the station.
2. Press the GUI button to switch the GUI mode ON. GUI indications for the selected function are displayed.
3. Press  $\uparrow/\downarrow$  to switch to the Sub Menu display.

(Example: TUNER)

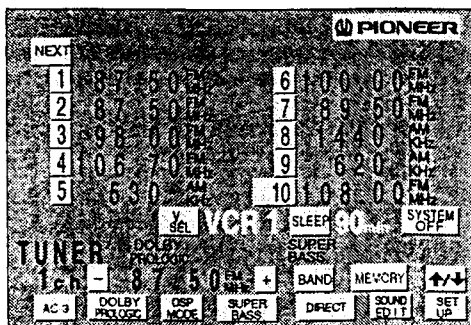

4. Select the video component you want to watch with the V.SEL (VIDEO SIGNAL SELECTOR) button.
5. Start playback of the component selected with the FUNC. button and the component selected with the V.SEL button.

### CAUTION:

If you must operate the V.SEL button during recording, do so after setting the recording VCR to the pause mode. If the button is operated when the tape is traveling during recording, the recorded image and sound may be disrupted at the point at which the button is operated.

**SOUND EDIT OPERATION (GUI OPERATION)**

- If you press the SOUND EDIT button on a function operation display, display switches to "SOUND EDIT" indications for the currently selected surround mode. (Press the EXIT button to return to the original function operation display.)
- On the SOUND EDIT display, you can adjust levels and balances set to the speaker mode, etc.

(When using PRO-LOGIC THEATER)

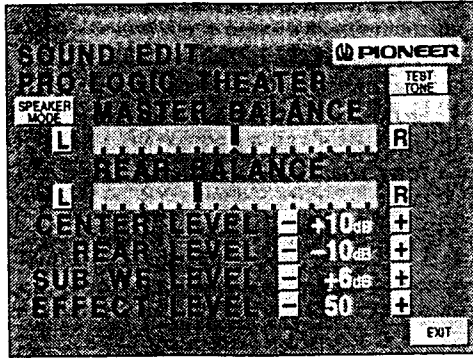

**SETTING THE SPEAKER MODE**

You can set this unit to match the requirements and specifications of your stereo system's speakers (whether or not center speaker(s), rear speakers or a sub-woofer are used, speaker size, etc.) to assure optimum sound quality.

- Pressing the SPEAKER MODE button on the "SOUND EDIT" display takes you to the "SPEAKER MODE" display.

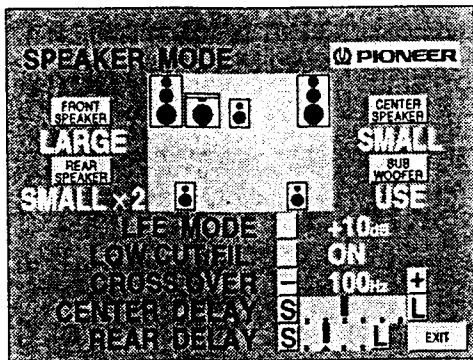

- Set the SPEAKER MODE using the different buttons.



Selects the size of the front L, R speakers.

LARGE ↔ SMALL



Selects center speaker size, or NONE if no center speaker is used.

→ LARGE → SMALL → NONE →



Selects the size and number (1 or 2) of rear speakers, or NONE if no rear speakers are used.

→ LARGE x 2 → SMALL x 2 → LARGE  
← NONE ← SMALL ←

During Pro-Logic reproduction, this unit does not let you switch between NORMAL, WIDE, and PHANTOM center mode settings. However, setting the SPEAKER MODE as follows provides the same effects as these modes.

Front	Center		
LARGE	SMALL	→	NORMAL
LARGE	LARGE	→	WIDE
LARGE	NONE	→	PHANTOM

Set the rear speaker to NONE for conventional 3CH Logic reproduction.

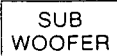

Selects whether there is a sub-woofer or not.

USE ↔ NONE



- Attenuate LFE (Low Frequency Effect = ultra-low bass effect for more powerful movie sound or music) level. It changes in sequence each time the  button is pressed.

→ +10 dB → 0 dB → OFF →

**NOTE:**

If you set to "+10 dB", front three channel (L + R + C) output power is required for the sub-woofer. If this is more power than the sub-woofer can handle, clipping may occur resulting in distortion.



- Switch ON if the sub-woofer does not have high power handling capabilities. (This enables bass boosting while reducing the possibility of the sub-woofer clipping.)

ON ↔ OFF



- Set sub-woofer crossover frequency (highest frequency it can reproduce). Press  to lower the crossover frequency and press  to raise it. (100 Hz/150 Hz/200 Hz)



- Sets center channel delay time. Press  for shorter delay, press  for longer delay.
- This is possible only when the AC-3 is selected.



- Set rear (surround) channel delay time. Press  for shorter delay, press  for longer delay.
- This is possible only when the AC-3 or PRO-LOGIC is selected.

Pressing  returns you to SOUND EDIT display.

**LEVEL AND BALANCE ADJUSTMENT**

- First, perform settings in the "SETTING THE SPEAKER MODE". (Refer to page 29.)
- If you press the SOUND EDIT button on a function operation display, display switches to "SOUND EDIT" indications for the currently selected surround mode.

(When using PRO-LOGIC THEATER)

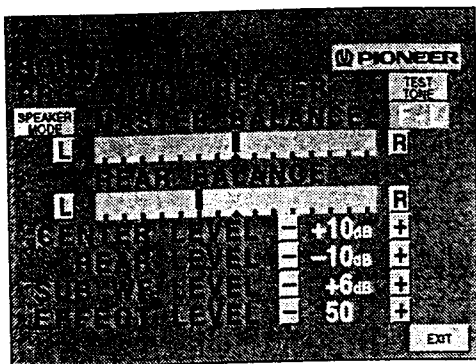

- Adjust level and balance settings with the buttons.
- In the "SETTING THE SPEAKER MODE", parameters for channels set to "NONE" cannot be adjusted.

**SPEAKER MODE** Switches to the SPEAKER MODE display. (Refer to page 29.)

**TEST TONE** This switches the test tone signal used for adjustment ON, OFF. When ON, the test tone is output through each channel in turn. The display below the TEST TONE button indicates the channel through which the test tone is being output.  
(Example) F-L : Front Left channel

**MASTER BALANCE** [L] [R]

- Adjust the system's overall left/right volume level balance.
- Press [L] and the right channel's volume level decreases.
- Press [R] and the left channel's volume level decreases.

**REAR BALANCE** [L] [R]

- Adjust rear channel left/right volume level balance.
- Press [L] and the right rear channel's volume level decreases.
- Press [R] and the left rear channel's volume level decreases.

**CENTER LEVEL** [-] [+]

- Adjust center channel volume level. (± 10 dB)
- Press [-] to lower volume, press [+] to raise volume.

**REAR LEVEL** [-] [+]

- Adjust rear channel volume level. (± 10 dB)
- Press [-] to lower volume, press [+] to raise volume.

**SUB WF LEVEL** [-] [+]

- Adjust sub-woofer channel volume level. (± 10 dB)
- Press [-] to lower the volume, press [+] to raise volume.

**NOTE:**

If you adjust the level to match a program source with little bass, clipping may occur with a program source that has a lot of bass, resulting in distortion from the sub-woofer. Pay careful attention to sub-woofer channel output, making sure the level is not too high.

**EFFECT LEVEL** [-] [+]

- Adjust surround effect level. (10 - 80)
- Press [-] to reduce the surround effect, press [+] to increase it.

Press [EXIT] to return to the original function display.

■ **Adjustment using the TEST TONE**

1. Press the TEST TONE button to switch ON.
  - The test tone is output from channels set in the "SETTING THE SPEAKER MODE".
2. Use the [L], [R], [+], and [-] buttons to adjust channel volume level balance.
  - Adjust so that the volume level of each channel is the same.
3. Press the TEST TONE button to switch OFF.
4. Press the EXIT button.



**Learning**

Pioneer remote control commands are in the non-preset gray buttons, but you can use them to learn remote control signals from your component's remote control.

1. Perform the first three steps of "Calling up and setting up presets".
2. Select the gray button you want to use for learning and press. The "STANDBY" indication flashes. (If you remain in STANDBY for about 1 minute, it is canceled.)

(Example: Using the 0 button for learning)

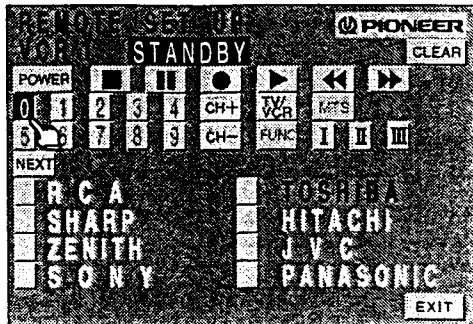

3. Point your component's remote control at this unit's remote sensor window and press the selected button.

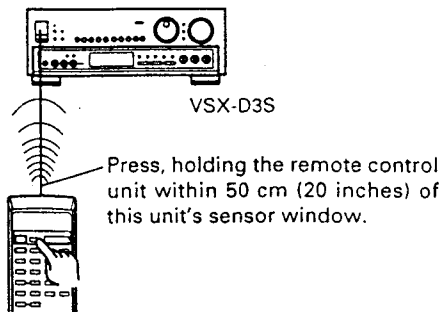

- If "OK" is displayed, learning has been completed. If you want to use another button for learning, repeat steps 2 and 3.

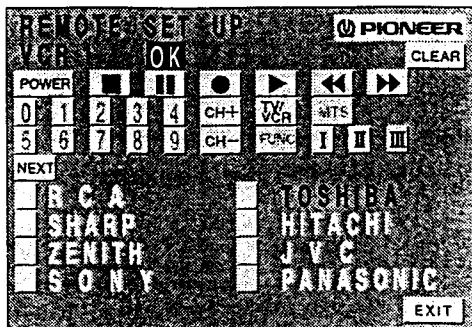

- If "NG" is displayed, repeat steps 2 and 3.
- When you have completed learning, press the EXIT button.

**NOTE:**

- To return the buttons you used for learning to their original settings, press the CLEAR button. This returns them to the original Pioneer remote control commands.
- There are no signals in buttons I, II, and III, so you can use them for learning.
- Even when "OK" is displayed during learning, operation may still not be possible. If this happens, repeat the learning procedures. With some manufacturers' components, learning may be difficult to perform. Learning may also not be possible if the remote control's batteries are run down. If this is the case, load the remote control with new batteries and repeat the learning procedures.
- Even black preset buttons can be used for learning other commands.
- Learning a command may not be possible if many commands requiring a large amount of memory have already been learned resulting in insufficient memory remaining.



# ONE TOUCH OPERATION SET UP (GUI OPERATION)

ISC Intelligent System Control

- Sets the operation signal that is transmitted when a remote control ONE TOUCH OPERATION button is pressed.
- Initially, Pioneer remote control signals are transmitted. (Figure 1)

(Figure 1: Initial settings for LD)

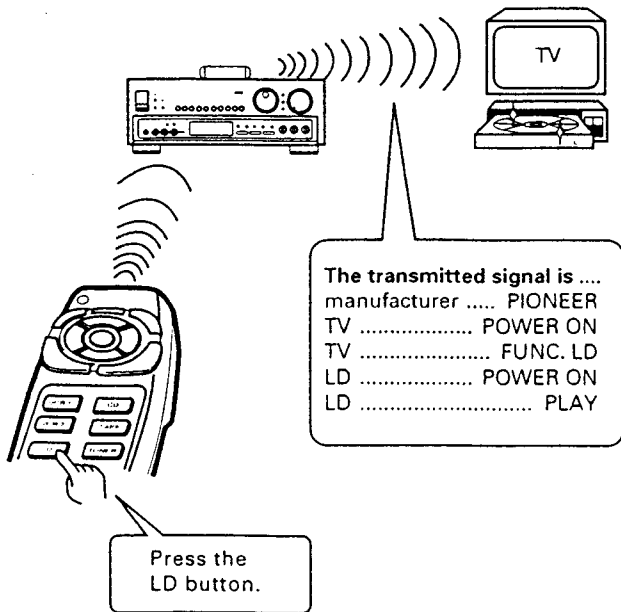

To operate other manufacturers' components, first complete REMOTE SET UP procedures (page 31).

Example : When you want to change LD ONE TOUCH OPERATION commands.

1. Press the SET UP button for display of the operation buttons of each function.

The SET UP MENU is displayed.

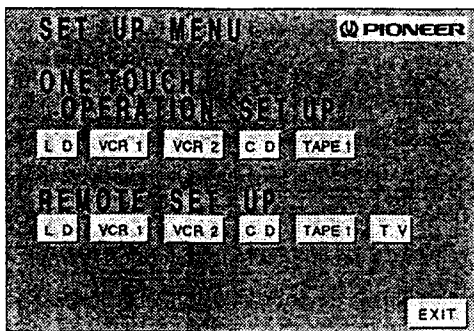

2. Select LD from the five ONE TOUCH OPERATION SET UP function buttons. ONE TOUCH OPERATION SET UP indications are displayed.

(Example: LD)

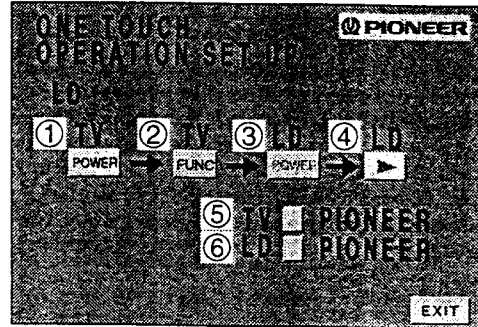

① ~ ④

You can select which operation buttons will transmit operation signals and those which will not.

When the operation button's character is black, a signal will be transmitted. If it is gray, it will not be transmitted. The button's character color changes each time it is pressed.

- With other manufacturers' components, if power is on when the POWER signal is transmitted, power is switched off. When the TV "FUNC" signal is transmitted, the TV function may not become the function connected to the receiver. For this reason, when other manufacturers' presets are called up with REMOTE SET UP, commands are not automatically transmitted.

⑤, ⑥

TV and LD manufacturers settings are displayed.

- If you use REMOTE SET UP (page 31) to call up another manufacturers' presets, that manufacturers' name is displayed.
- When you use the REMOTE SET UP learning function (page 32), the "PIONEER" indication becomes gray. Remote control signals set with REMOTE SET UP are transmitted. To return to the original Pioneer remote control commands, press the ON/OFF button (on the left of "PIONEER") to turn the "PIONEER" indication black. (If they are not the original Pioneer remote control commands, even Pioneer components may switch OFF when the POWER command is transmitted, or there may be some other incorrect operation.)

3. After completing the settings, press the EXIT button.

**NOTE:**

With original Pioneer remote control commands, the TV function always becomes "LD", so connect the receiver's VIDEO OUT (TO MONITOR TV) terminal to the TV's LD video input terminal.

# TROUBLESHOOTING

Incorrect operations are often mistaken for trouble and malfunctions. If you think that there is something wrong with this component, check the points below. Sometimes the trouble may lie in another component. Investigate the other components and electrical appliances being used.

If the trouble cannot be rectified even after exercising the checks listed below, ask your nearest PIONEER authorized service center or your dealer to carry out repair work.

Symptom	Cause	Remedy
Power does not come on even when the POWER switch is pressed.	<ul style="list-style-type: none"> <li>● Power cord is disconnected.</li> <li>● Instances are rare, but the problem may be due to the operation of the protector circuit.</li> </ul>	<ul style="list-style-type: none"> <li>● Connect cord securely.</li> <li>● Unplug the power cord of the unit from the AC wall outlet, then plug it in again.</li> </ul>
Control is not possible regardless of what operation button is pressed.	<ul style="list-style-type: none"> <li>● Static electricity affects the unit when the air is dry, such as in winter.</li> </ul>	<ul style="list-style-type: none"> <li>● Unplug the power cord of the unit from the AC wall outlet, then plug it in again.</li> <li>● Press the RESET button.</li> <li>● If static electricity is pronounced, it is recommended that you operate the unit using the remote control unit.</li> </ul>
No sound is produced, even when the input selector button is selected.	<ul style="list-style-type: none"> <li>● Connections are incorrect.</li> <li>● The MUTE button is pressed.</li> <li>● VOLUME is turned down.</li> </ul>	<ul style="list-style-type: none"> <li>● Consult pages 6 — 10 and perform connections correctly.</li> <li>● Press the MUTE button to cancel the MUTING effect.</li> <li>● Raise volume.</li> </ul>
	<ul style="list-style-type: none"> <li>● Speaker connecting wires are disconnected from speaker terminals.</li> </ul>	<ul style="list-style-type: none"> <li>● Connect wires to terminals securely.</li> </ul>
	<ul style="list-style-type: none"> <li>● One or both of the input cords are disconnected.</li> </ul>	<ul style="list-style-type: none"> <li>● Connect input cords securely.</li> </ul>
	<ul style="list-style-type: none"> <li>● TAPE 2 MONITOR button is in the ON position.</li> </ul>	<ul style="list-style-type: none"> <li>● Press the button again to the OFF position.</li> </ul>
	<ul style="list-style-type: none"> <li>● The SPEAKERS button is OFF.</li> </ul>	<ul style="list-style-type: none"> <li>● Switch the SPEAKERS button ON.</li> </ul>
No picture is produced, even when the input selector button is selected.	<ul style="list-style-type: none"> <li>● Connections are incorrect.</li> <li>● The selected input selector button is not correct.</li> </ul>	<ul style="list-style-type: none"> <li>● Consult pages 6 — 10 and perform connections correctly.</li> <li>● Press the correct button.</li> </ul>
High noise level.	<ul style="list-style-type: none"> <li>● Station has not been tuned in to correct frequency.</li> </ul>	<ul style="list-style-type: none"> <li>● Tune the station in correctly.</li> </ul>
	<ul style="list-style-type: none"> <li>● Antenna has not been connected or has become disconnected.</li> </ul>	<ul style="list-style-type: none"> <li>● Connect the antenna securely.</li> </ul>
	<b>FM reception</b> <ul style="list-style-type: none"> <li>● Accessory FM antenna remains bundled up or it is not pointing in the right direction.</li> </ul>	<ul style="list-style-type: none"> <li>● Stretch both ends of antenna taut and locate direction yielding optimum reception.</li> </ul>
	<ul style="list-style-type: none"> <li>● Weak broadcasting station signals.</li> </ul>	<ul style="list-style-type: none"> <li>● Replace accessory FM antenna with an outdoor FM antenna.</li> </ul>
	<b>AM reception</b> <ul style="list-style-type: none"> <li>● AM loop antenna is not pointing in the right direction.</li> </ul>	<ul style="list-style-type: none"> <li>● Change the direction of the AM loop antenna and find a position where reception is improved.</li> </ul>
	<ul style="list-style-type: none"> <li>● Weak broadcasting station signals.</li> </ul>	<ul style="list-style-type: none"> <li>● Erect an outdoor AM antenna or connect a ground wire.</li> </ul>
	<ul style="list-style-type: none"> <li>● Noise is being picked up by this unit from other equipment (especially electrical appliances using motors or fluorescent lights).</li> </ul>	<ul style="list-style-type: none"> <li>● Turn off the appliances generating noise or remove them from the vicinity of the stereo equipment.</li> <li>● Separate the antenna from the unit by some distance.</li> </ul>

## TROUBLESHOOTING

Symptom	Cause	Remedy
No auto stop.	<ul style="list-style-type: none"> <li>● Input signals are not strong enough.</li> </ul>	<ul style="list-style-type: none"> <li>● (FM) If the supplied simple antenna is being used, change to an outdoor antenna.</li> </ul>
TV source cannot be seen when the VCR's TV tuner is used.	<ul style="list-style-type: none"> <li>● TV antenna is not connected to the VCR, or connections are faulty.</li> <li>● The VCR's input switch is set to line input.</li> </ul>	<ul style="list-style-type: none"> <li>● Consult the VCR's operating instructions, and connect the antenna correctly.</li> <li>● Set the VCR's input switch to built-in tuner.</li> </ul>
No rear sound is produced.	<ul style="list-style-type: none"> <li>● The SPEAKER MODE is set incorrectly.</li> <li>● The REAR LEVEL is turned down.</li> <li>● Speaker connecting wires are disconnected from the REAR SPEAKERS terminals.</li> </ul>	<ul style="list-style-type: none"> <li>● Set correctly.</li> <li>● Refer to page 30 and adjust the rear level.</li> <li>● Connect wires to the terminals securely.</li> </ul>
Remote control does not work.	<ul style="list-style-type: none"> <li>● Batteries are dead or missing in remote control unit.</li> <li>● Poor angle or too great a distance from the remote sensor window.</li> <li>● There is an obstacle between you and the remote sensor window.</li> <li>● A fluorescent light is shining on the remote sensor window.</li> <li>● The Main-repeater signal does not reach other components.</li> </ul>	<ul style="list-style-type: none"> <li>● Insert new batteries.</li> <li>● Use within 7 meters and within a 30 degree angle of the remote sensor window.</li> <li>● Change your position or move the obstacle.</li> <li>● Move the receiver so fluorescent light does not shine directly on the receiver's front panel remote sensor window.</li> <li>● Try changing the position of this unit or other units. If the signal still does not reach other components, use a supplied Mini-repeater.</li> </ul>

*Abnormal functioning of this unit may be caused by static electricity or other external interference. To restore normal operation, turn the power off and then on again, or unplug the AC power cord and then plug it in again.*

# APPENDIX A: SPECIFICATIONS

## Amplifier Section

### <2-channel mode>

Continuous average power output of 130 watts\* per channel, min., at 8 ohms, from 20 Hz to 20,000 Hz with no more than 0.05 %\*\* total harmonic distortion.

### <5-channel mode>

Continuous average power output of 100 watts\* per channel, min., at 8 ohms, from 20 Hz to 20,000 Hz with no more than 0.8 %\*\* total harmonic distortion.

\* Measured pursuant to the Federal Trade Commission's Trade Regulation rule on Power Output Claims for Amplifiers.

\*\* Measured by Audio Spectrum Analyzer.

### Continuous Power Output

Front	100 W + 100 W (1 kHz, 0.8 %, 8 Ω)
Center	100 W (1 kHz, 0.8 %, 8 Ω)
Rear	100 W + 100 W (1 kHz, 0.8 %, 8 Ω)

### [Multi-voltage model]

#### Continuous Power Output (DIN)

Front (1 kHz, T.H.D. 1 %, 8 Ω)	150 W + 150 W
Dynamic Power (2 Ω/4 Ω)	275 W/220 W

#### Input (Sensitivity/Impedance)

PHONO MM	2.8 mV/47 kΩ
CD, TAPE 1, TAPE 2, LD, VCR 1, VCR 2, VIDEO, TV/SAT	200 mV/47 kΩ

#### Phono Overload Level (T.H.D. 0.1%, 1 kHz)

PHONO MM	80 mV
----------	-------

#### Frequency Response

PHONO MM	20 Hz to 20,000 Hz ±0.3 dB
CD, TAPE 1, TAPE 2, LD, VCR 1, VCR 2, VIDEO, TV/SAT	5 Hz to 100,000 Hz ±3 dB

#### Output (Level/Impedance)

TAPE 1 REC, TAPE 2 REC	200 mV/2.2 kΩ
VCR 1 OUT, VCR 2 OUT	200 mV/2.2 kΩ

#### Tone Control

BASS	±8 dB (150 Hz)
TREBLE	±8 dB (10 kHz)
SUPER BASS	0 ~ +8 dB (80 Hz, variable)

#### Signal-to-Noise Ratio (IHF, short circuited, A network)

PHONO MM	76 dB
CD, TAPE 1, TAPE 2, LD, VCR 1, VCR 2, VIDEO, TV/SAT	98 dB

#### Signal-to-Noise Ratio (EIA, at 1 W (1 kHz))

PHONO MM	77 dB
CD, TAPE 1, TAPE 2, LD, VCR 1, VCR 2, VIDEO, TV/SAT	80 dB

## VIDEO Section

### Input (Sensitivity/Impedance)

VCR 1, VCR 2, LD, VIDEO, TV/SAT	1 Vp-p/75 Ω
---------------------------------	-------------

### Output (Level/Impedance)

VCR 1, VCR 2, MONITOR	1 Vp-p/75 Ω
-----------------------	-------------

### Frequency Response

VCR 1, VCR 2, LD, VIDEO → MONITOR	5 Hz to 10 MHz ±3 dB
--------------------------------------	----------------------

### Signal-to-Noise Ratio

	55 dB
--	-------

### Cross Talk

	55 dB
--	-------

## AC-3 Input Section

### AC-3 • RF (LD)

	1
--	---

### AC-3 • DIGITAL (TV/SAT)

	1
--	---

## FM Tuner Section

Frequency Range ..... 87.5 MHz to 108 MHz

Usable Sensitivity ..... Mono: 11.2 dBf, IHF (1.0 μV/75 Ω)

50 dB Quieting Sensitivity ..... Mono: 16.8 dBf

Stereo: 38.6 dBf

Signal-to-Noise Ratio ..... Mono: 80 dB (at 65 dBf)

Stereo: 76 dB (at 85 dBf)

Distortion ..... Stereo: 0.3 % (1 kHz)

Alternate Channel Selectivity ..... 65 dB (400 kHz)

Stereo Separation ..... 45 dB (1 kHz)

Frequency Response ..... 30 Hz to 15 kHz (±3) dB

Antenna Input ..... 300 Ω balanced

75 Ω unbalanced

## AM Tuner Section

Frequency Range ..... 531 kHz to 1,602 kHz (9 kHz step)

530 kHz to 1,700 kHz (10 kHz step)

Sensitivity (IHF, Loop antenna) ..... 300 μV/m

Selectivity ..... 25 dB

Signal-to-Noise Ratio ..... 50 dB

Antenna ..... Loop antenna

## Miscellaneous

### Power Requirements

U.S. and Canadian models ..... AC 120 V, 60 Hz

Multi-voltage model ..... AC 110 V/120-127 V/220 V/240 V

(Switchable), 50/60 Hz

### Power Consumption

U.S. and Canadian models ..... 455 W, 700 VA

Multi-voltage model ..... 1175 W

In Standby Condition ..... 5 W

### AC Outlets

U.S. and Canadian models

SWITCHED x 2 ..... TOTAL 100 W (0.8 A) MAX

UNSWITCHED x 1 ..... 100 W (0.8 A) MAX

Multi-voltage model

SWITCHED x 2 ..... TOTAL 100 W MAX

UNSWITCHED x 1 ..... 100 W MAX

Dimensions ..... 420 (W) x 162 (H) x 425 (D) mm

16-9/16 (W) x 6-3/8 (H) x 16-3/4 (D) in

### Weight (without package)

U.S. and Canadian models ..... 15.0 kg (33 lb 1 oz)

Multi-voltage model ..... 15.2 kg (33 lb 8 oz)

## Furnished Parts

FM T-type Antenna ..... 1

AM Loop Antenna ..... 1

Dry Cell Batteries (size "AA" IEC R6P) ..... 2

Remote Control Unit ..... 1

Main-Repeater ..... 1

Mini-Repeater ..... 1

Operating Instructions ..... 1

## NOTE:

Specifications and the design are subject to possible modifications without notice, due to improvements.

## APPENDIX B: SURROUND EFFECT

This unit has a built-in surround processor for adding presence and an expansive effect to the sound.

### 5 Mode Selection with DSP (Digital Signal Processor):

#### **JAZZ:**

This gives you the sound field of a jazz club.

#### **DANCE:**

A "hot" high-energy sound, with extra reverb for greater ambience.

#### **SIMULATED SURROUND:**

The "SIMULATED SURROUND" creates the effects of reverberated and reflected sound from the walls and ceiling similar to a concert hall. These sound-effects added to the actual sound from the source make you feel as if you were in a more expanded space. The different ranges of the expanded space can be set by the REAR DELAY TIME button.

The "SIMULATED SURROUND" also gives effects on monaural sources by outputting the added reverberated sound from the rear speakers while outputting the actual source sound from the front speakers. Turn on the "SIMULATED SURROUND" for a monaural source to gain effective surround playback.

#### **HALL:**

You can enjoy a convincing hall sound.

#### **THEATER:**

This gives you the sound field of an atmosphere of a movie theater.

- You can use these five modes in combination with AC-3 and PRO-LOGIC.

### DOLBY PRO-LOGIC SURROUND:

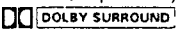
Choose this setting for movies and music (especially Video Discs and video tapes bearing the  mark) playback.

DOLBY PRO-LOGIC SURROUND continuously detects the size and direction of the dominant signal and cancels undesirable crosstalk, thereby providing signal emphasis.

It makes you clearly perceive the directional source of the music. Real flow of sound also can be re-created naturally using this feature. You can feel as if being in an outstanding and expansive sound field.

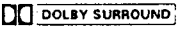
Even if the video recordings do not bear the  mark, some of them may be Dolby Surround encoded.

Choose the SIMULATED SURROUND mode if the source sound signal is mono. Little or no sound will be heard from the surround speakers if the DOLBY PRO-LOGIC SURROUND mode is selected.

### DOLBY 3CH LOGIC:

Select "NONE" with the SPEAKER MODE REAR SPEAKER button, press the DOLBY PRO-LOGIC button ON and DOLBY 3CH LOGIC is selected.

Combining the rear speaker signal with that of the front speakers results in your being able to enjoy a regenerated sound field which has comparatively more presence and a more expansive feeling from the front 3 channels (front L, front R, and center speakers) than that of ordinary stereo regeneration. DOLBY 3CH LOGIC can be used with stereo sources not encoded with DOLBY SURROUND.

### DOLBY AC-3:

Choose this setting for movies and music (especially video discs bearing the  mark) playback. The LaserDisc player's AC-3 RF OUT jack must be connected to this unit's AC-3 RF IN jack.

AC-3 is the compression format used when recording 6-channel audio onto the digital track of film for the SR D (Surround Digital) movie theater surround system. To enable AC-3 to reproduce the same multi-track audio in the home on laserdisc, the six independent audio channels compressed by the AC-3 system are recorded on the right analog stereo channel. Among these six channels, the sub-woofer signal (SW) is exclusively for low-range reproduction. Since this SW signal is not really necessary as far as the total system is concerned, the number of channels is expressed as 5.1.

## APPENDIX C: DOLBY AC-3 SURROUND

Dolby Laboratories spearheaded home theater with the introduction of Dolby Surround, and then defined it with the follow-up format Dolby Pro-Logic Surround. They have continued the evolution of home theater with the introduction of Dolby AC-3 Pro-Logic, a Multi-Channel Digital delivery system. Just as Dolby Surround found it's beginnings in the cinema, so does AC-3. This advanced multi-channel digital sound, although originally conceived for and later chosen for HDTV, made it practical to implement in the cinema because it enabled the film to retain the analog soundtrack. With backwards compatibility a priority so the film could be played in any cinema, it was decided to place the new digital optical track between the sprocket holes, which was a key factor in defining its maximum practical bit rate (see illustration).

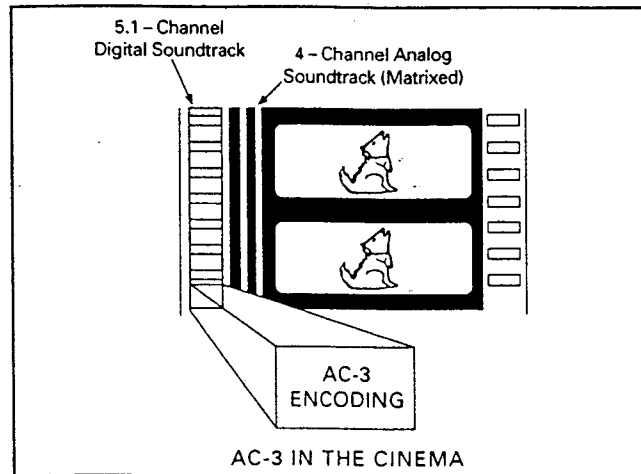

In 1992 Dolby Surround Digital, the film sound format with AC-3 as its keystone, made its debut in the cinema. In less than three years, more than 300 feature films had been released in this new format, and nearly 1,500 cinemas had been equipped for playback of the digital soundtrack. Furthermore, AC-3 can now be brought to the consumer's home today via the LaserDisc.

Traditional Pulse Code Modulation (PCM), which is utilized on compact discs and LD's 4-channel matrixed digital audio tracks, uses a 16-bit word to "describe" the sampled point in the original analog wave. By sampling this analog wave 44,100 times per second for each channel, the system will yield a dynamic range of 96 dB from the loudest sound to the noise floor. However, this process creates an immense amount of data which is too large for multi-channel systems. Thus, a form of data reduction must be employed to reduce the total amount of information without serious degradation of the sound quality — hence the introduction of AC-3.

The premise of AC-3 is simple, it reproduces the full bit resolution (16-bit) when a lower resolution will not result in the same sound quality. However, when a lower resolution is acceptable, it will utilize this lower resolution opting instead for psychoacoustical theories and digital noise filtering technologies to help insure acceptable sound quality.

**THE LASER DISC FORMAT**

The one major concern when the idea of including another form of audio on a laser disc was .... Backwards Compatibility. It would not do the laser disc format any justice, especially in a time of growing acceptability, to change the audio system without considering those consumers that had already purchased a laser disc player. Thus to maintain backward compatibility, the AC-3 encoding was deemed to be stored in one of the existing analog tracks.

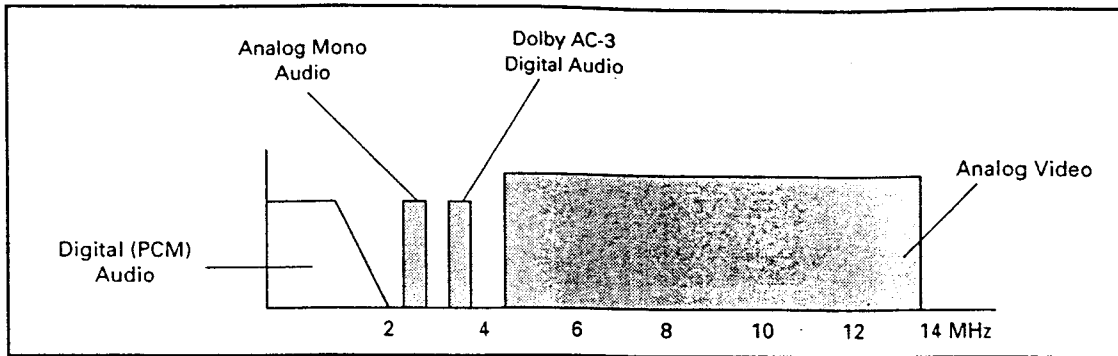

The above diagram shows the format of the AC-3 Pro-Logic laser disc. The PCM audio track, containing the 4-channel matrixed digital soundtrack, was fully maintained for continued use in laser disc players with digital capabilities. As mentioned above, one of the analog channels will now contain the AC-3 encoding, while the other analog channel will contain a mono analog soundtrack, which still provides backwards compatibility with those pre-1984 laser disc players (1984 was the year we introduced an LD player with digital capabilities).

**THE ADVANTAGES OF AC-3 OVER PRO-LOGIC**

AC-3 is called a 5.1-channel system because it provides 5 independent channels (left, right, center, left surround, and right surround), all reproducing a 20 – 20,000 Hz range. In addition, the system provides for an independent sub-woofer channel, which is called a low frequency effects channel. Use of the low frequency effect channel is optional, since the 5 channels provide a full frequency bandwidth, but available for those consumer wishing to include a sub-woofer for thunderous bass reproduction. Furthermore, AC-3 provides improved channels separation, multi-directional discrete capability, and increased sound-design creative flexibility (for the movie makers). Below highlights some of the other advantages of Dolby AC-3:

	DOLBY SURROUND DIGITAL (AC-3)	DOLBY SURROUND PRO-LOGIC
Available Channels on Disc	5.1 Channels	2 channels
Playback Channels	5.1 Channels	4 channels
Description of Playback Channels	Left, Right, Center, Left Surround, Right Surround, and Sub-woofer	Left, Right, Center, and Surround
Sound Processing	Discrete Digital AC-3 Encoding & Decoding	Analog Matrix Processing for Dolby Surround
Surround Channel Maximum Frequency Response	20,000 Hz	7,000 Hz
Other Information	<ul style="list-style-type: none"> <li>- 5 Discrete Channels</li> <li>- Fully Backward Compatible with Dolby Surround</li> <li>- High Dynamic Range</li> <li>- Extremely Accurate and Natural Sound for Vocals and Effects Imaging</li> </ul>	



## Dear Customer:

Selecting fine audio equipment such as the unit you've just purchased is only the start of your musical enjoyment. Now it's time to consider how you can maximize the fun and excitement your equipment offers. This manufacturer and the Electronic Industries Association's Consumer Electronics Group want you to get the most out of your equipment by playing it at a safe level. One that lets the sound come through loud and clear without annoying blaring or distortion—and, most importantly, without affecting your sensitive hearing.

Sound can be deceiving. Over time your hearing "comfort level" adapts to higher volumes of sound. So what sounds "normal" can actually be loud and harmful to your hearing. Guard against this by setting your equipment at a safe level BEFORE your hearing adapts.

### To establish a safe level:

- Start your volume control at a low setting.
- Slowly increase the sound until you can hear it comfortably and clearly, and without distortion.

### Once you have established a comfortable sound level:

- Set the dial and leave it there.

Taking a minute to do this now will help to prevent hearing damage or loss in the future. After all, we want you listening for a lifetime.

## We Want You Listening For A Lifetime

Used wisely, your new sound equipment will provide a lifetime of fun and enjoyment. Since hearing damage from loud noise is often undetectable until it is too late, this manufacturer and the Electronic Industries Association's Consumer Electronics Group recommend you avoid prolonged exposure to excessive noise. This list of sound levels is included for your protection.

Decibel Level	Example
30	Quiet library, soft whispers
40	Living room, refrigerator, bedroom away from traffic
50	Light traffic, normal conversation, quiet office
60	Air conditioner at 20 feet, sewing machine
70	Vacuum cleaner, hair dryer, noisy restaurant
80	Average city traffic, garbage disposals, alarm clock at two feet.

### THE FOLLOWING NOISES CAN BE DANGEROUS UNDER CONSTANT EXPOSURE

90	Subway, motorcycle, truck traffic, lawn mower
100	Garbage truck, chain saw, pneumatic drill
120	Rock band concert in front of speakers, thunderclap
140	Gunshot blast, jet plane
180	Rocket launching pad

Information courtesy of the Deafness Research Foundation.



### MAINTENANCE OF EXTERNAL SURFACES

- Use a polishing cloth or dry cloth to wipe off dust and dirt.
- When the surfaces are dirty, wipe with a soft cloth dipped in some neutral cleanser diluted five or six times with water, and wrung out well, and then wipe again with a dry cloth. Do not use furniture wax or cleaners.
- Never use thinners, benzine, insecticide sprays or other chemicals on or near this unit, since these will corrode the surfaces.

Published by Pioneer Electronic Corporation.  
Copyright © 1995 Pioneer Electronic Corporation.  
All rights reserved.

**PIONEER ELECTRONIC CORPORATION** 4-1, Meguro 1-Chome, Meguro-ku, Tokyo 153, Japan  
**PIONEER ELECTRONICS [USA] INC.** P.O. BOX 1540, Long Beach, California 90801-1540  
**PIONEER ELECTRONICS OF CANADA, INC.** 300 Allstate Parkway, Markham, Ontario L3R 0P2, Canada  
**PIONEER ELECTRONIC [EUROPE] N.V.** Haven 1087 Keetberglaan 1, 9120 Melsele, Belgium, TEL: 03/570.05.11  
**PIONEER ELECTRONICS AUSTRALIA PTY. LTD.** 178-184 Boundary Road, Braeside, Victoria 3195, Australia, TEL: [03] 580-9911  
**PIONEER ELECTRONICS DE MEXICO S.A. DE C.V.** Augusto Rodin No. 128 PB Col. San Juan Mixcoac Mexico D.F. CP.03730 TEL: 52-5-598-3950